

## DETAILS

<b>Product Number</b>	F14170_FLORENCE-ZT25
<b>Family</b>	Florence
<b>Type</b>	Lens array
<b>Color</b>	clear
<b>Diameter</b>	286 + 61 mm
<b>Height</b>	11 mm
<b>Style</b>	rectang
<b>Optic Material</b>	PMMA
<b>Holder Material</b>	
<b>Fastening</b>	screw
<b>Status</b>	production ready
<b>ROHS Compliant</b>	Yes
<b>Date Updated</b>	31/07/2017



## OPTICAL PROPERTIES

LED	Viewing Angle	Light Beam	Efficiency	cd/lm	Connector
5630 (ASMU-LWG0-NxxE)	Asymmetric deg	Asymmetric	94 %	0.570	-
TRIDINO R3 8x0 1100 1ft HV	Asymmetric deg	Asymmetric	94 %	0.590	-
XP-G	sim: Asymmetric	Asymmetric	sim: 94 %	-	-
XH-B/G	Asymmetric deg	Asymmetric	93 %	0.500	-
LG 5630	Asymmetric deg	Asymmetric	94 %	-	-
LG 6030	Asymmetric deg	Asymmetric	94 %	0.600	-
LUXEON 3535 2D	Asymmetric deg	Asymmetric	94 %	0.600	-
LUXEON 3030 2D	Asymmetric deg	Asymmetric	92 %	0.560	-
LUXEON XR-3535L (L202 - xxx033C3003)	Asymmetric deg	Asymmetric	94 %	0.610	-
MP-2016	Asymmetric deg	Asymmetric	94 %	0.630	-
NF2x757D	Asymmetric deg	Asymmetric	94 %	0.600	-
NF2x757G	Asymmetric deg	Asymmetric	sim: 93 %	sim: 0.610	-
Duris E5	Asymmetric deg	Asymmetric	94 %	0.600	-
Duris S5 (Single chip)	Asymmetric deg	Asymmetric	94 %	0.600	-
OSCONIQ P 2226	Asymmetric deg	Asymmetric	93 %	0.500	-
PLG2-BAR-1100-xxx-280x55-DC	Asymmetric deg	Asymmetric	94 %	0.600	-
Duris S2	Asymmetric deg	Asymmetric	93 %	0.510	-
Duris E 2835	sim: Asymmetric	Asymmetric	sim: 94 %	sim: 0.610	-
Oslon Square Gen3	Asymmetric deg	Asymmetric	94 %	0.580	-
Fortimo LED Line 1ft 650lm 8x0 3R xV2/3V3	Asymmetric deg	Asymmetric	sim: 93 %	sim: 0.630	-
Fortimo LED Line 1ft 1100lm xx0 3R xV2/3V3	Asymmetric deg	Asymmetric	sim: 93 %	-	-
Fortimo LED Line 1ft 2000lm 8xx 3R HV2	Asymmetric deg	Asymmetric	94 %	0.620	-
LM561B	Asymmetric deg	Asymmetric	94 %	0.600	-
LM231 A/B	Asymmetric deg	Asymmetric	94 %	0.600	-
LT-R286A	Asymmetric deg	Asymmetric	94 %	0.590	-



# PRODUCT DATASHEET

## Florence series

last update 31/7/2017

### OPTICAL PROPERTIES

LED	Viewing Angle	Light Beam	Efficiency	cd/lm	Connector
LM28xB Series	sim: Asymmetric	Asymmetric	sim: 94 %	sim: 0.640	-
LM561B Plus	Asymmetric deg	Asymmetric	94 %	0.590	-
SEOUL 5630C	sim: Asymmetric	Asymmetric	sim: 94 %	sim: 0.610	-
SEOUL 5630D	sim: Asymmetric	Asymmetric	sim: 94 %	sim: 0.620	-
STARK LLE-55-280-1650 CLASSIC	Asymmetric deg	Asymmetric	94 %	0.570	-

NOTE: INCOMPATIBLE WITH C14437\_FLORENCE-PF-3R

4  
3  
Bottom view  
Led center position

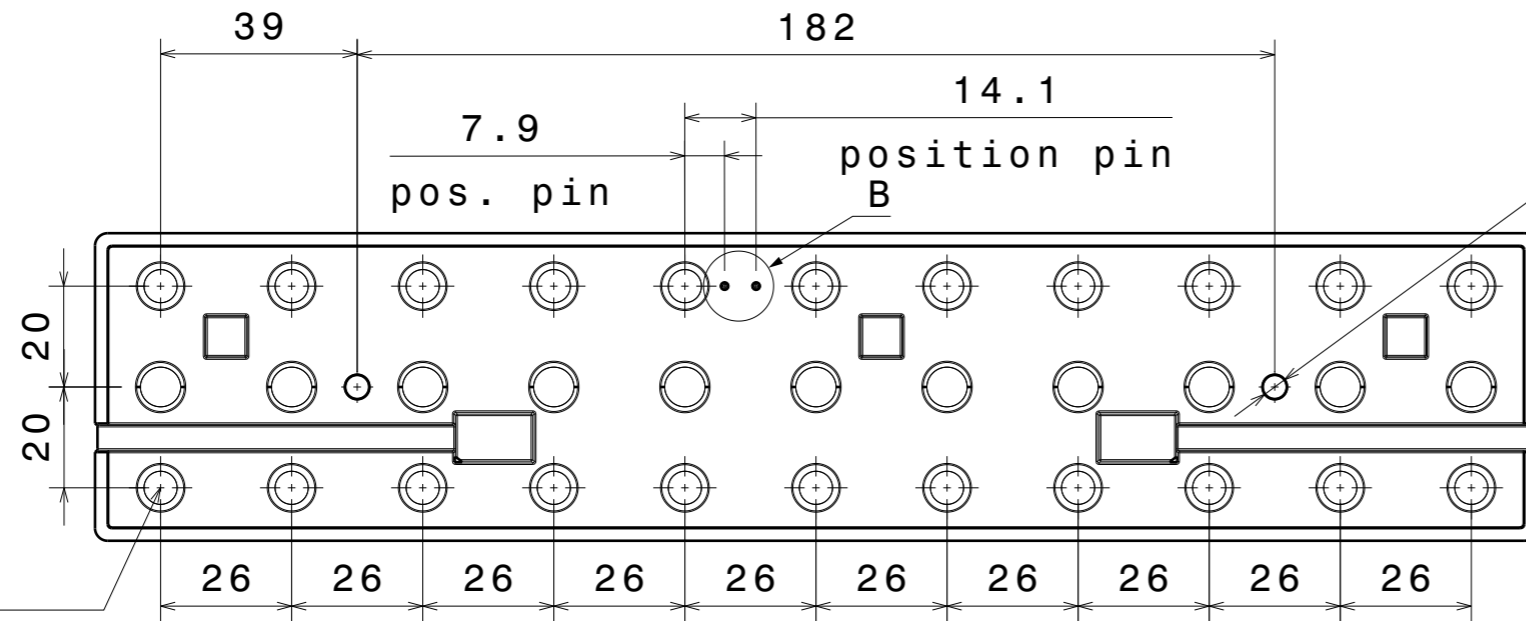

$\phi 4.8$   
M4 screw recommended

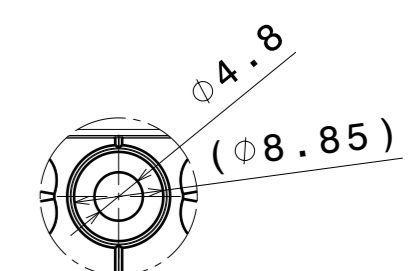

Detail A

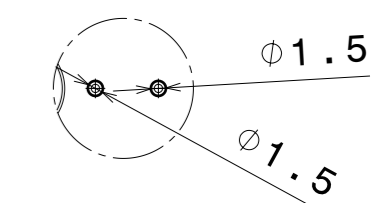

Detail B

Wire outlet both sides

Front view

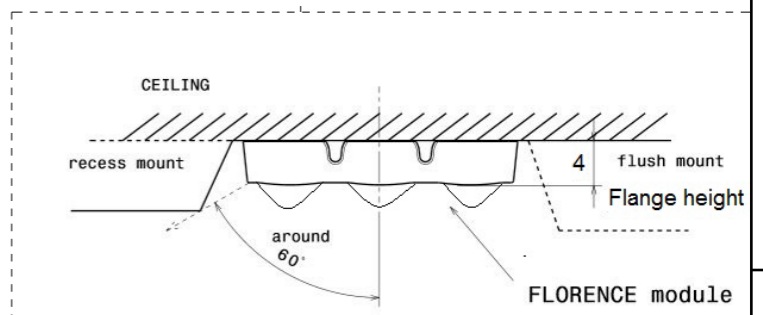
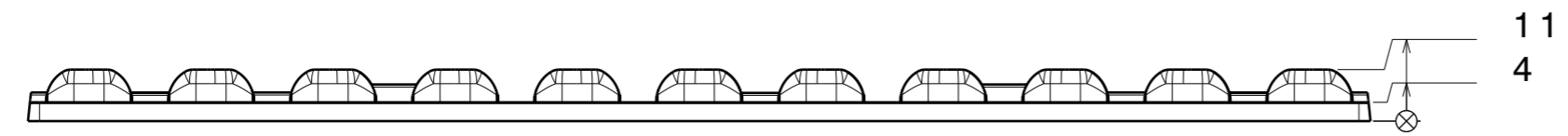

Typical setup

Top view

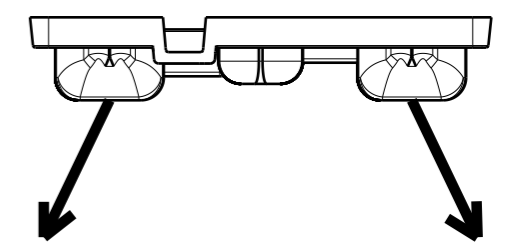
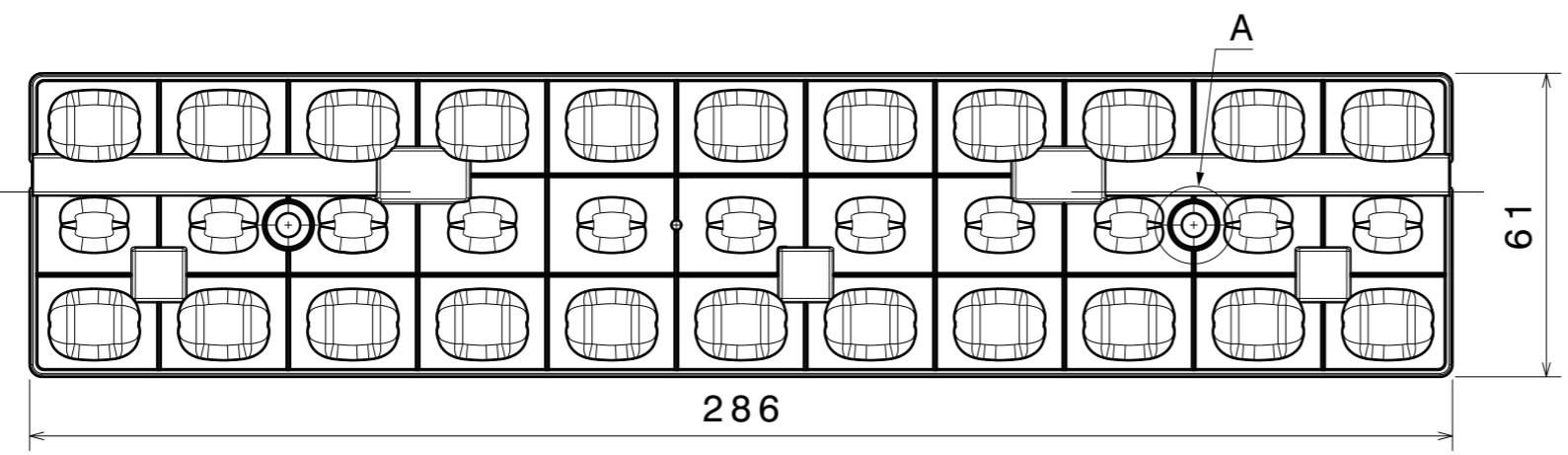

Double asymmetric light direction

PCB EXAMPLE

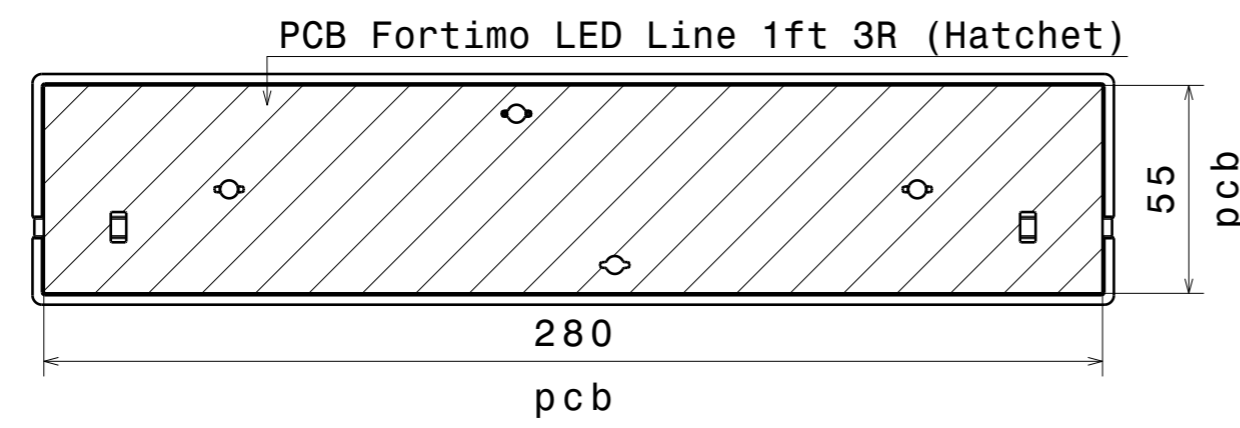

Tolerances if not otherwise shown  
According to DIN ISO 2768-1  
Linear measures:  
Up to 30mm class M, otherwise class C.  
According to DIN ISO 2768-2  
Form and position: class L

THIRD ANGLE PROJECTION:

This drawing is the property of LEDiL Oy. It may not be reproduced, copied or communicated without a written agreement with LEDiL Oy.

INDEX	PART NO	DESCRIPTION	MATERIAL	COLOUR
1	F14170	FLORENCE-ZT25	PMMA	

**LEDiL** LediL Oy  
Salorankatu 10  
FIN 24240 SALO  
Finland

DRAWING TITLE  
**F14170\_FLORENCE-ZT25**

SIZE	PART NUMBER		
<b>A3</b>	<b>F14170</b>		

SCALE	1:1	WEIGHT	76 g	SHEET	1/1
-------	-----	--------	------	-------	-----

Luminaire: LEDiL Oy F14170\_FLORENCE-ZT25\_(AVAGO 5630 0.5W)  
Lamps: 1 x AVAGO ASMU-LWG0-NxxxE 1677.82lm@420mA 34.8V

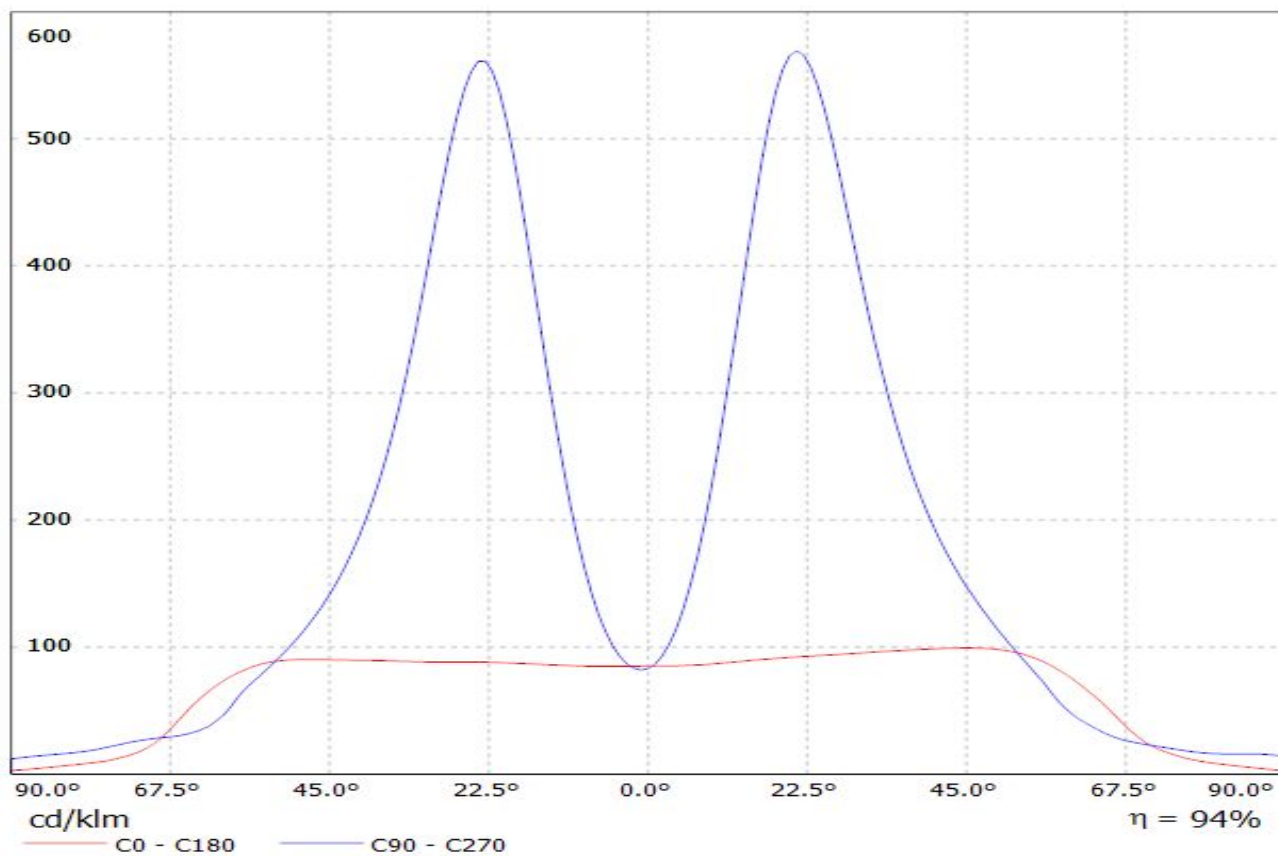

Luminaire: LEDiL Oy F14170\_FLORENCE-ZT25\_(TRIDINO-R3)\_GS

Lamps: 1 x Comet\_Electronic sin\_TRIDINO-R3-8x0-1100-1ft-HV\_1299.6lm@250mA\_P=8.07304W\_I=0.250A

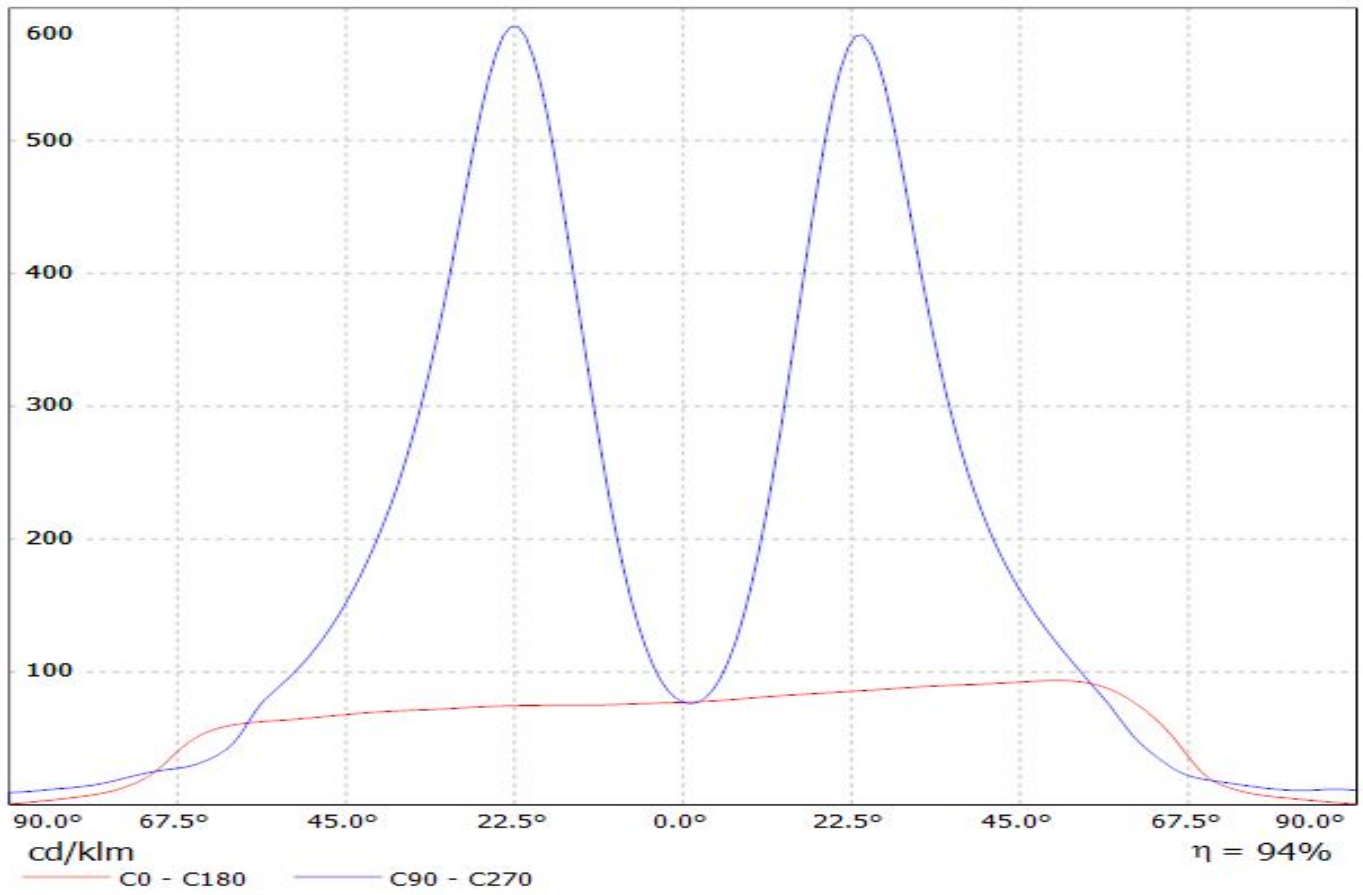

Luminaire: LEDiL Oy F14170\_FLORENCE-ZT25\_(XH-G) Eff: 93%  
Lamps: 1 x Cree\_XH-G\_(XHGAWT-0-7B4-J30-0H)\_1063.31lm@250mA\_P=8.12225W\_I=0.2498A

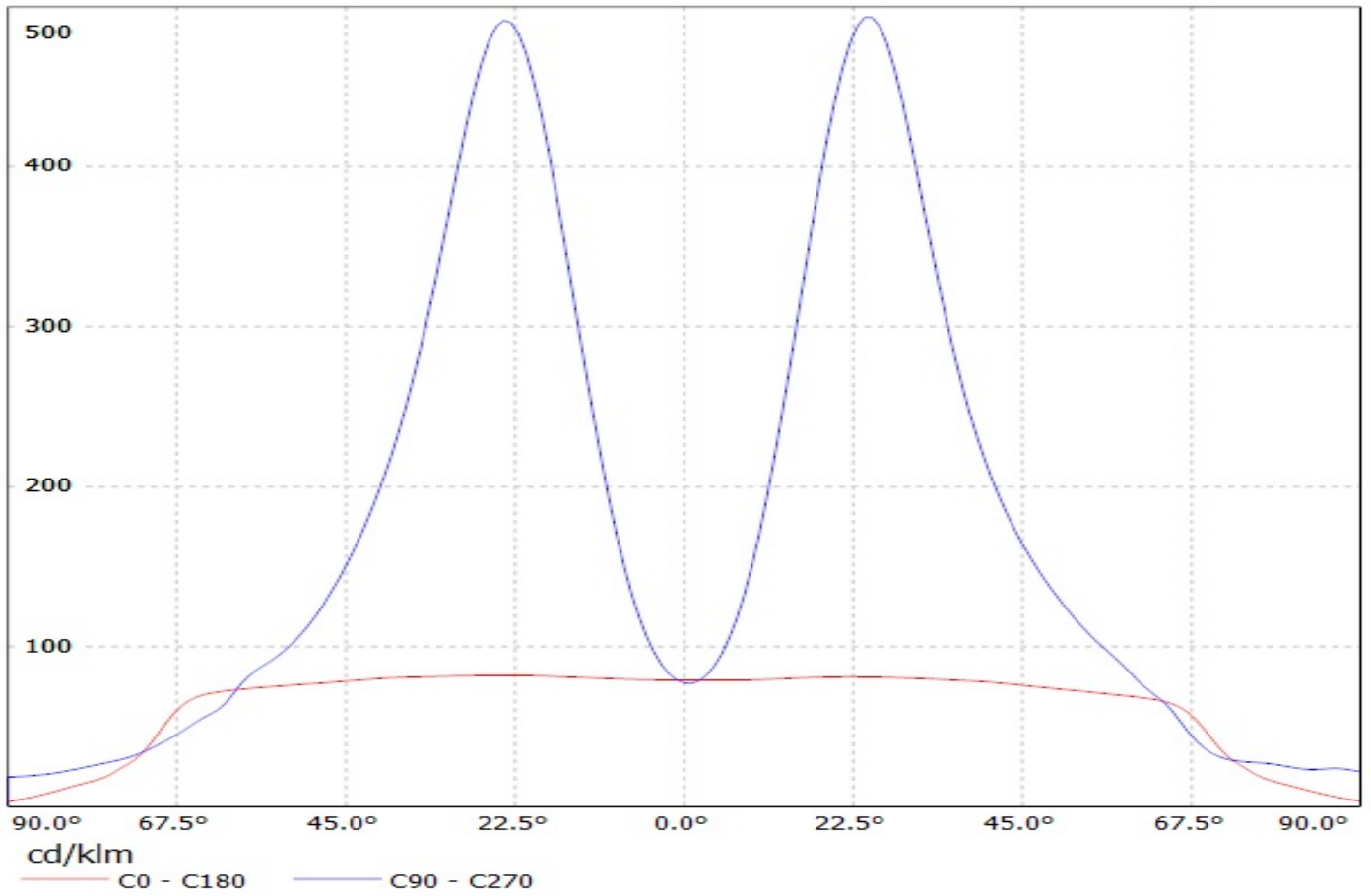

Luminaire: LEDiL Oy F14170\_FLORENCE-ZT25\_(LG\_5630)

Lamps: 1 x FLORENCE\_FORTIMO\_(LG\_5630)\_1000.68lm@250mA P=8.35483W I=250.7mA

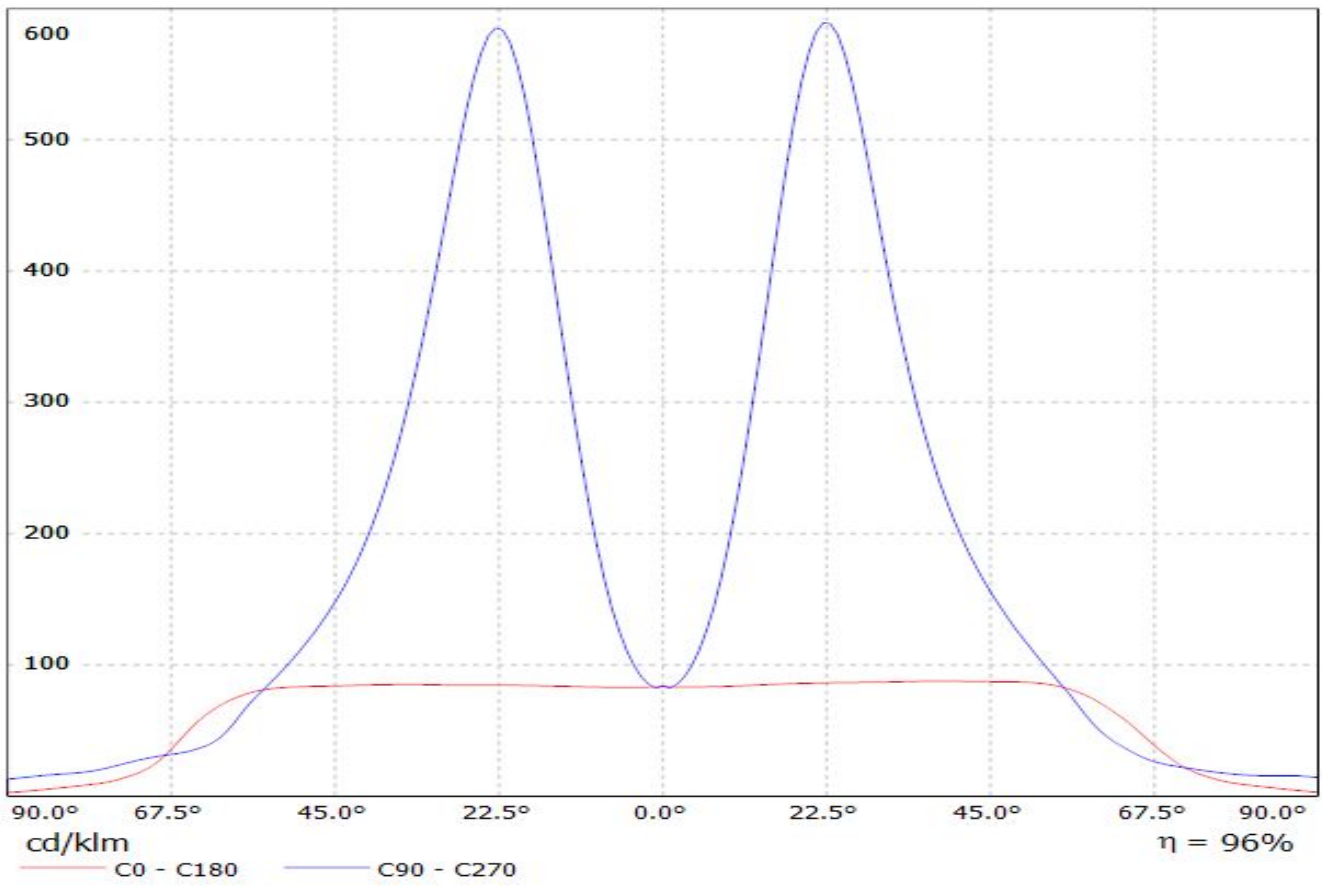

Luminaire: LEDiL Oy F14170\_FLORENCE-ZT25\_(LG\_6030) Eff: 94%  
Lamps: 1 x LG\_6030\_(LEWMS68T80HZ)\_1082lm@250mA\_P=7.86385W\_I=0.2499A

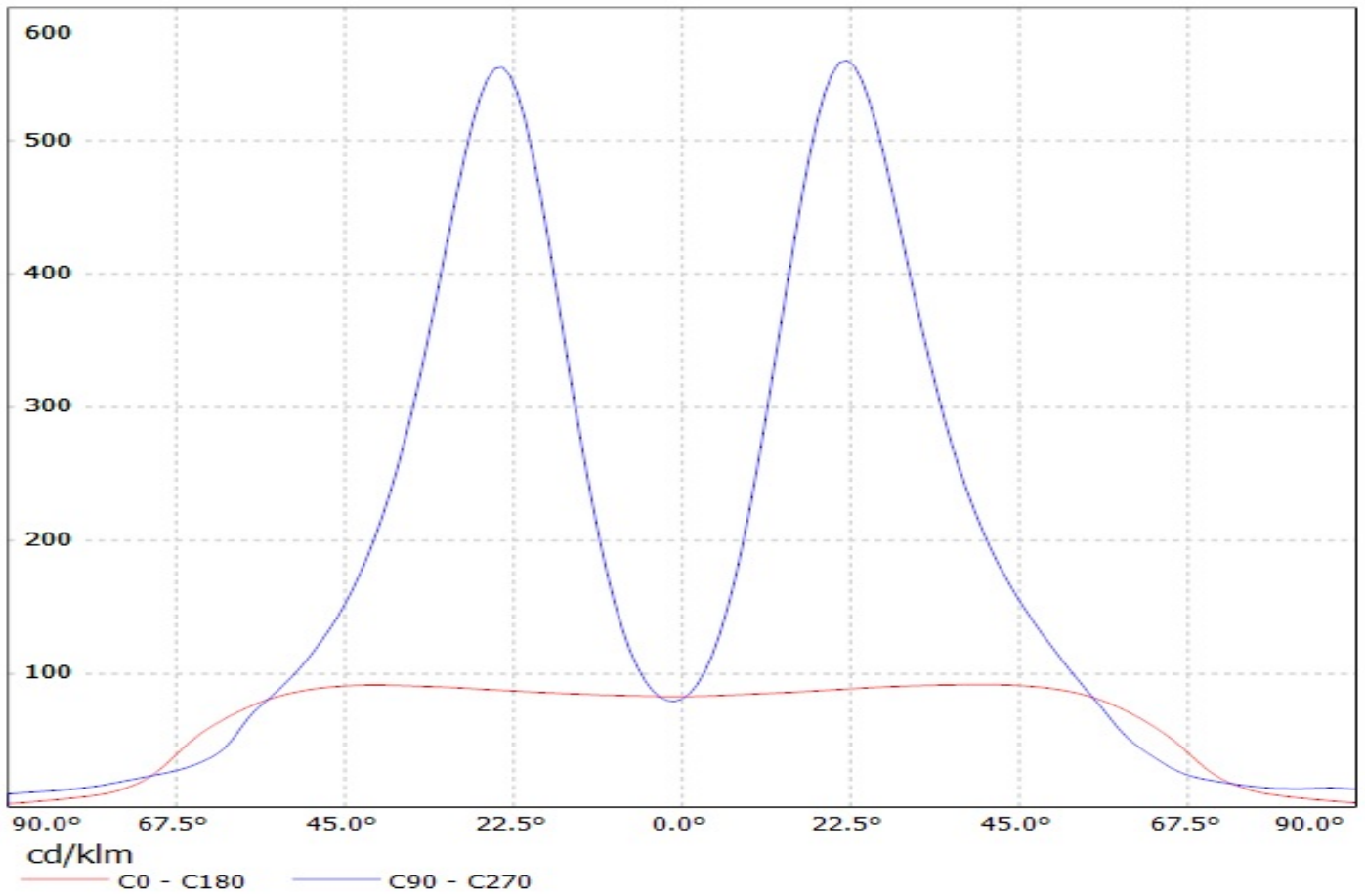



Luminaire: LEDiL Oy F14170\_FLORENCE-ZT25\_(Luxeon\_3535) Eff: 94%  
Lamps: 1 x Luxeon\_3535\_2D\_(MXC8-PW40-0000)\_1516.52lm@200mA\_P=12.6909W\_I=0.1999A

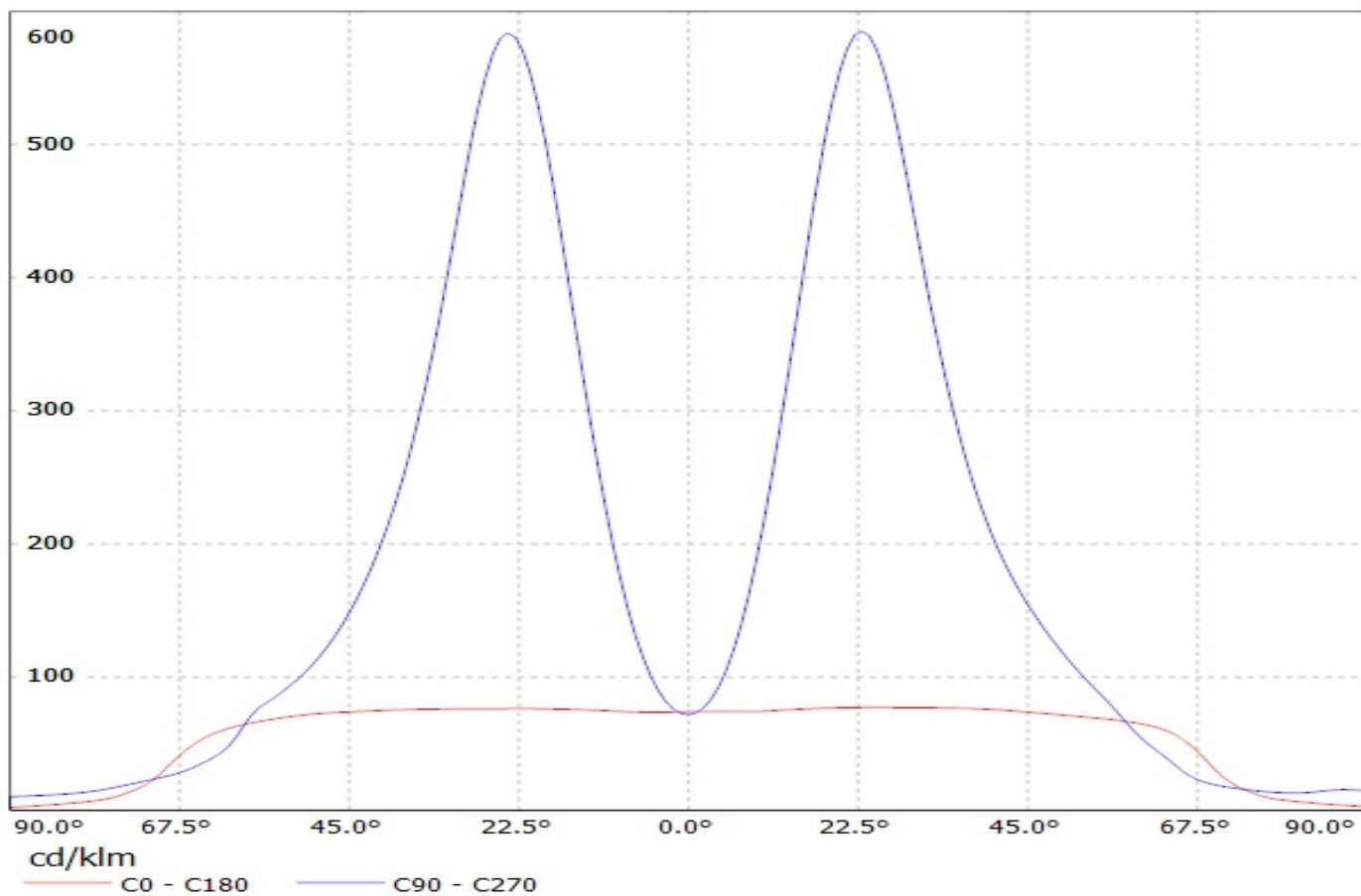

# Ledil F14170\_FLORENCE-ZT25\_(Luxeon\_3030\_2D) / LDC (Linear)

Luminaire: Ledil F14170\_FLORENCE-ZT25\_(Luxeon\_3030\_2D)  
Lamps: 1 x Luxeon\_3030\_2D\_3x11\_(L130-4080003000W21)  
\_1601.44lm@300mA\_CCT=4000K\_P=12.8W\_I=0.3A

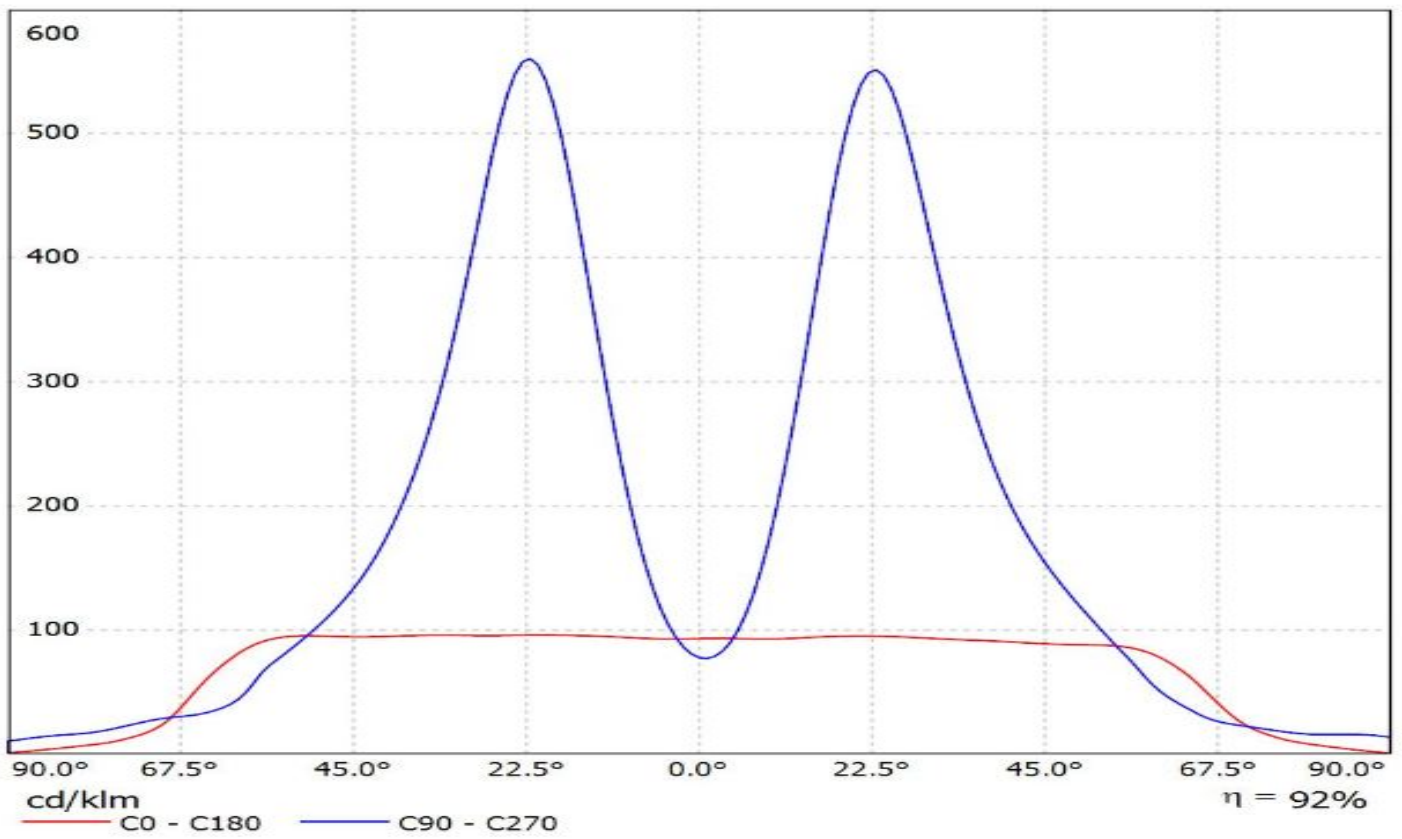

# Ledil F14170\_FLORENCE-ZT25\_(Luxeon\_XR-3535L) / LDC (Linear)

Luminaire: Ledil F14170\_FLORENCE-ZT25\_(Luxeon\_XR-3535L)  
Lamps: 1 x Lumileds Luxeon XR-3535L\_3x11\_(L202-3080033C30001)  
\_1087.37lm@250mA\_CCT=3000K\_P=8.15W\_I=0.25A

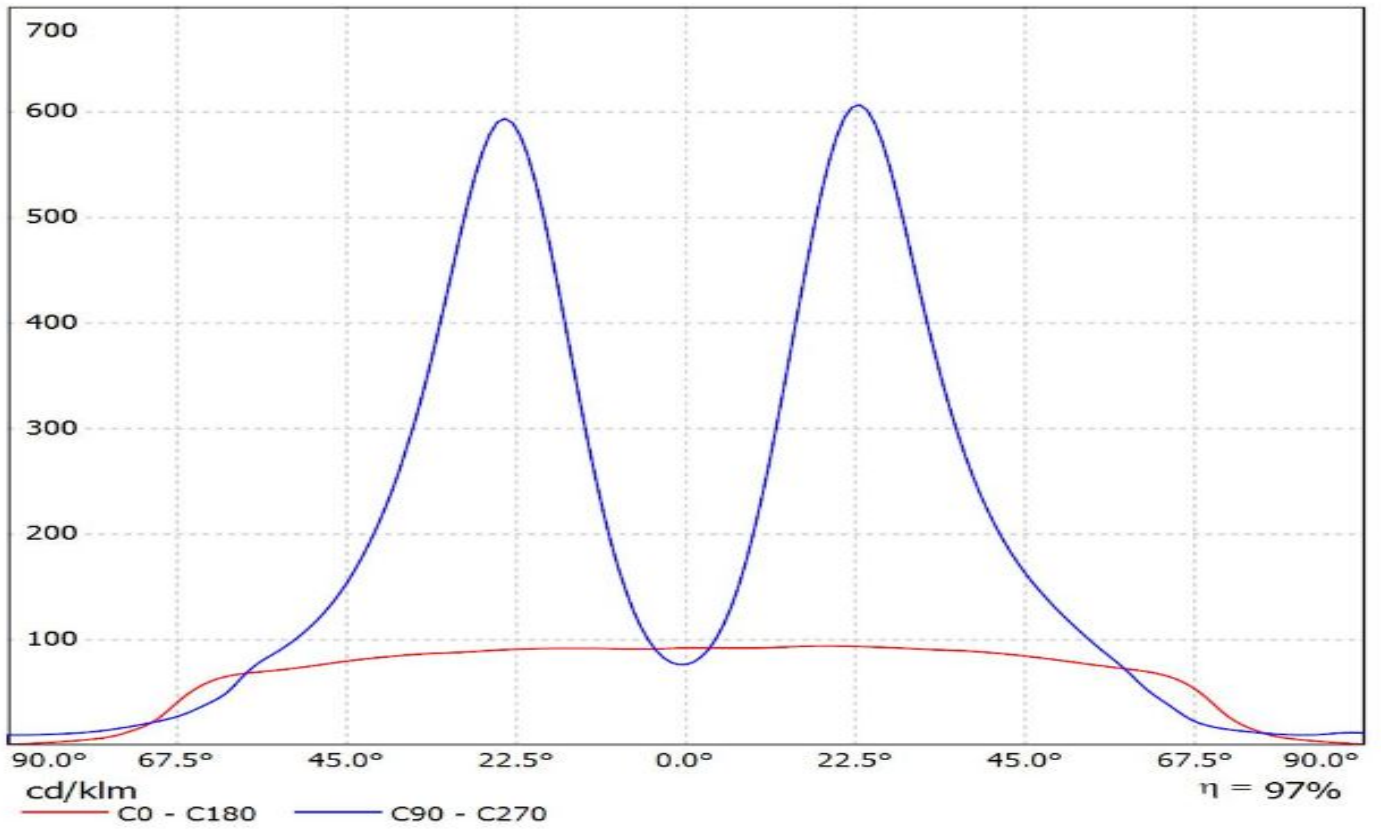

## Ledil F14170\_FLORENCE-ZT25\_(MP-2016) / LDC (Linear)

Luminaire: Ledil F14170\_FLORENCE-ZT25\_(MP-2016)

Lamps: 1 x Luminus\_MP-2016\_x22\_(LUMMP-1100-30-80)\_715.864lm@180mA\_P=6W\_I=0.18A

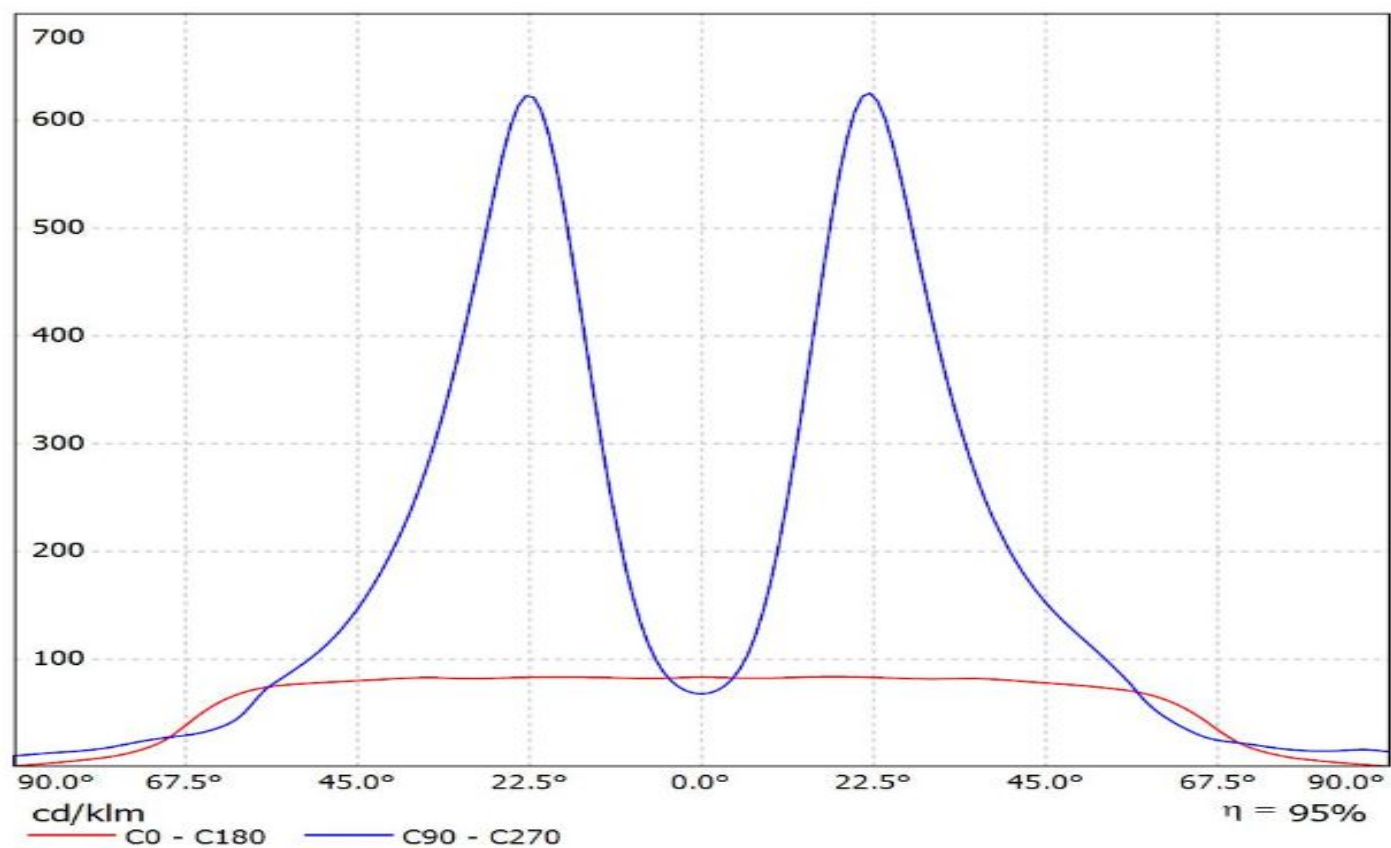

Luminaire: LEDiL Oy F14170\_FLORENCE-ZT25\_(NT2x757D) Eff: 94%  
Lamps: 1 x Nichia\_NT2x757D\_(NT2W757DRT)\_1465.4lm@150mA\_P=9.3849W\_I=0.15A

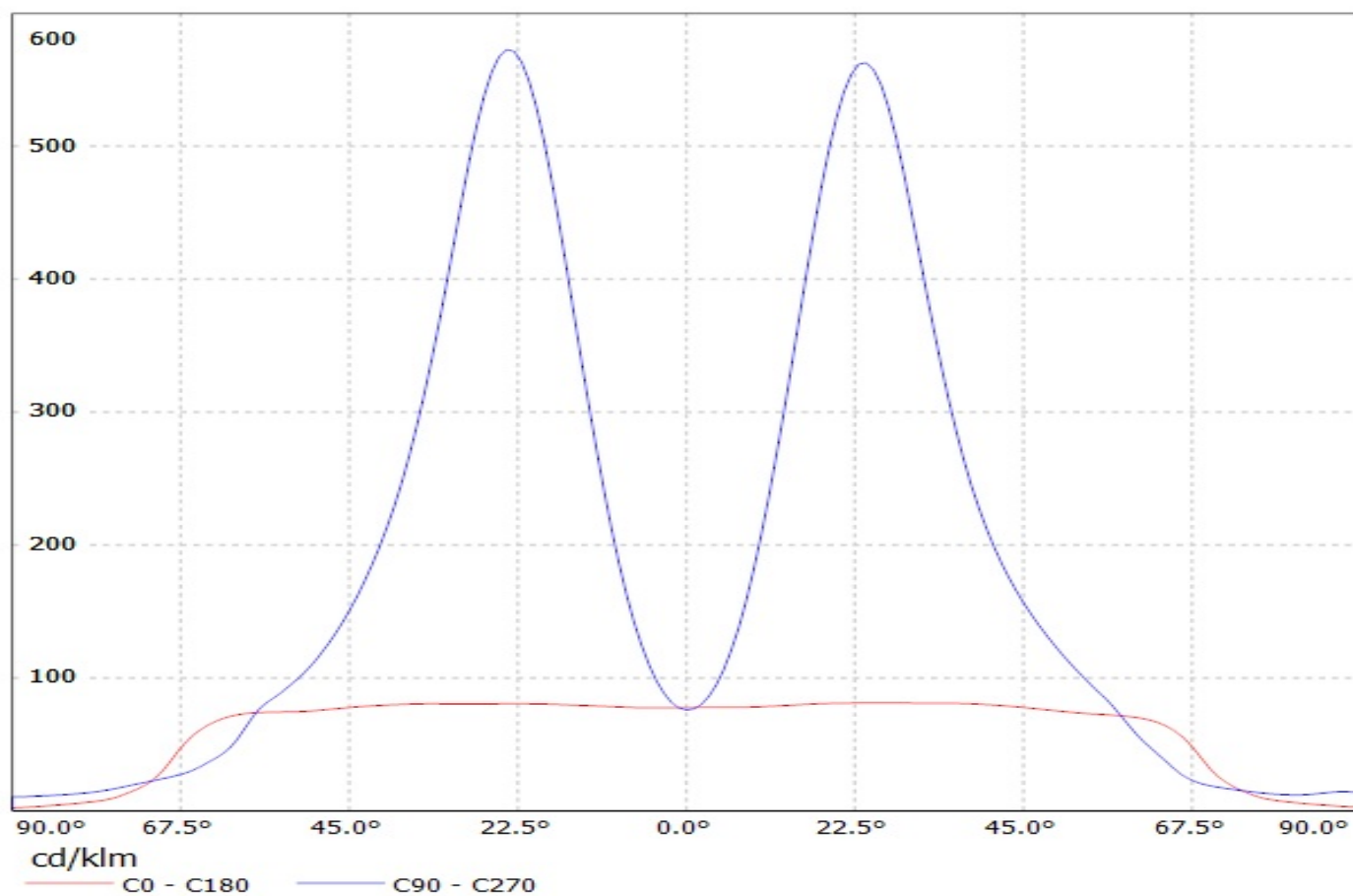

Luminaire: LEDiL Oy F14170\_FLORENCE-ZT25\_(DURIS\_E5) Eff: 94%  
Lamps: 1 x Osram\_DURIS\_E5\_570lm@120mA\_P=3.69459W\_I=120.2mA

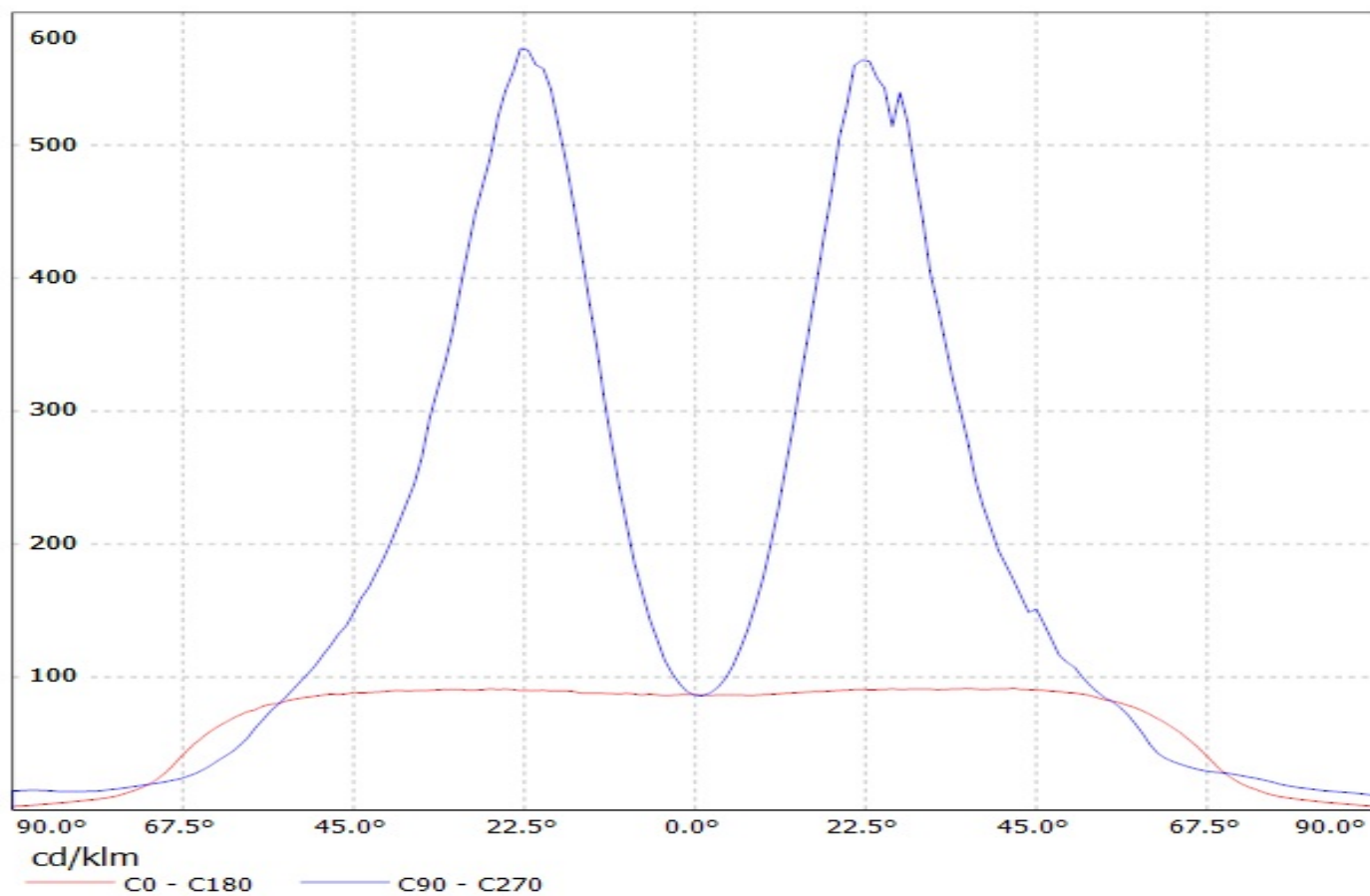

Luminaire: LEDiL Oy F14170\_FLORENCE-ZT25\_(DURIS\_S5) Eff: 94%  
Lamps: 1 x Osram\_DURIS\_S5\_511.3lm@120mA\_P=3.76574W\_I=120.1mA

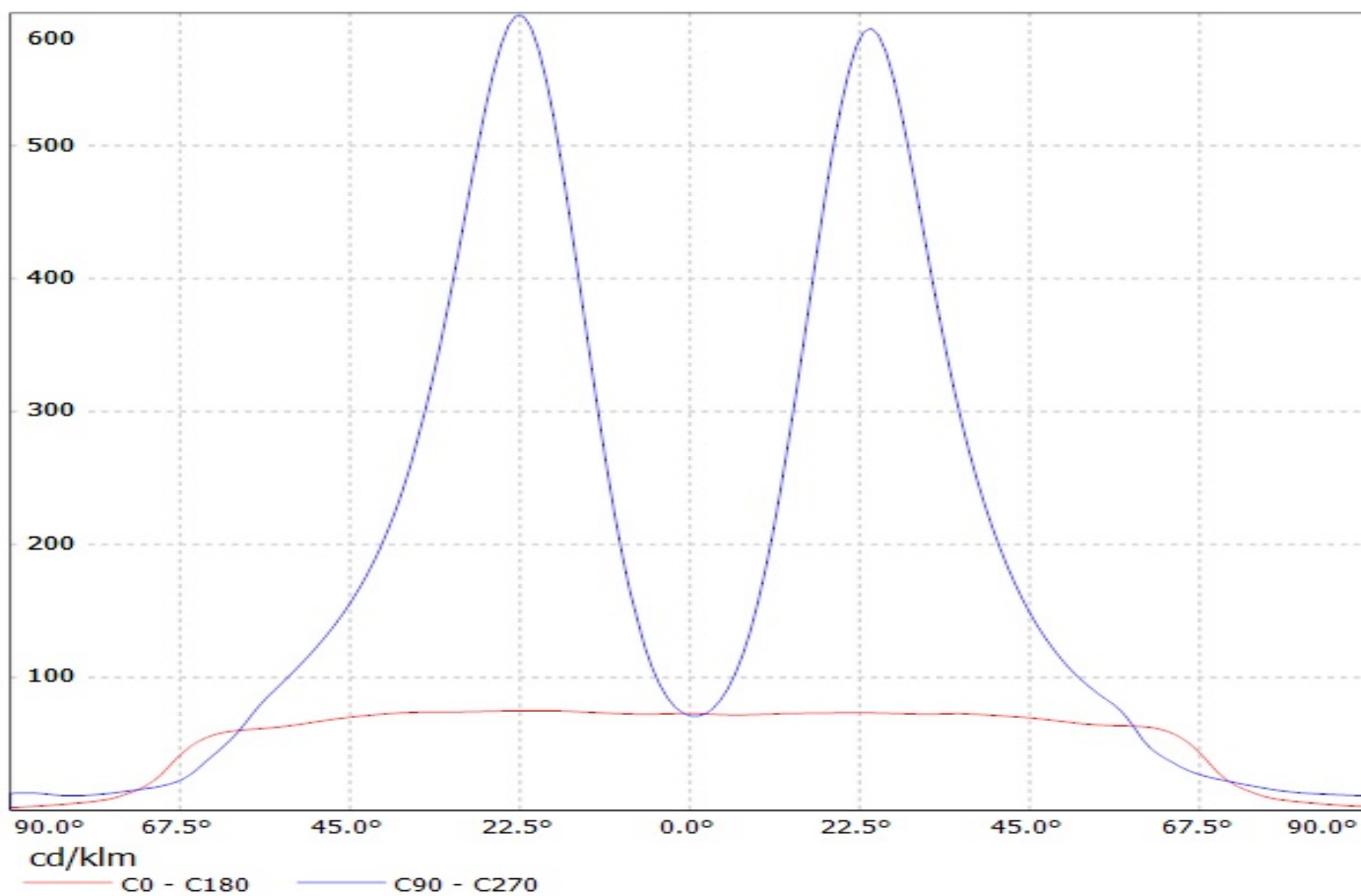

Luminaire: LEDiL Oy F14170\_FLORENCE-ZT25\_(Duris\_P5) Eff: 93%  
Lamps: 1 x Osram\_Duris\_P5\_756.444lm@250mA\_P=7.78777W\_I=249.8mA

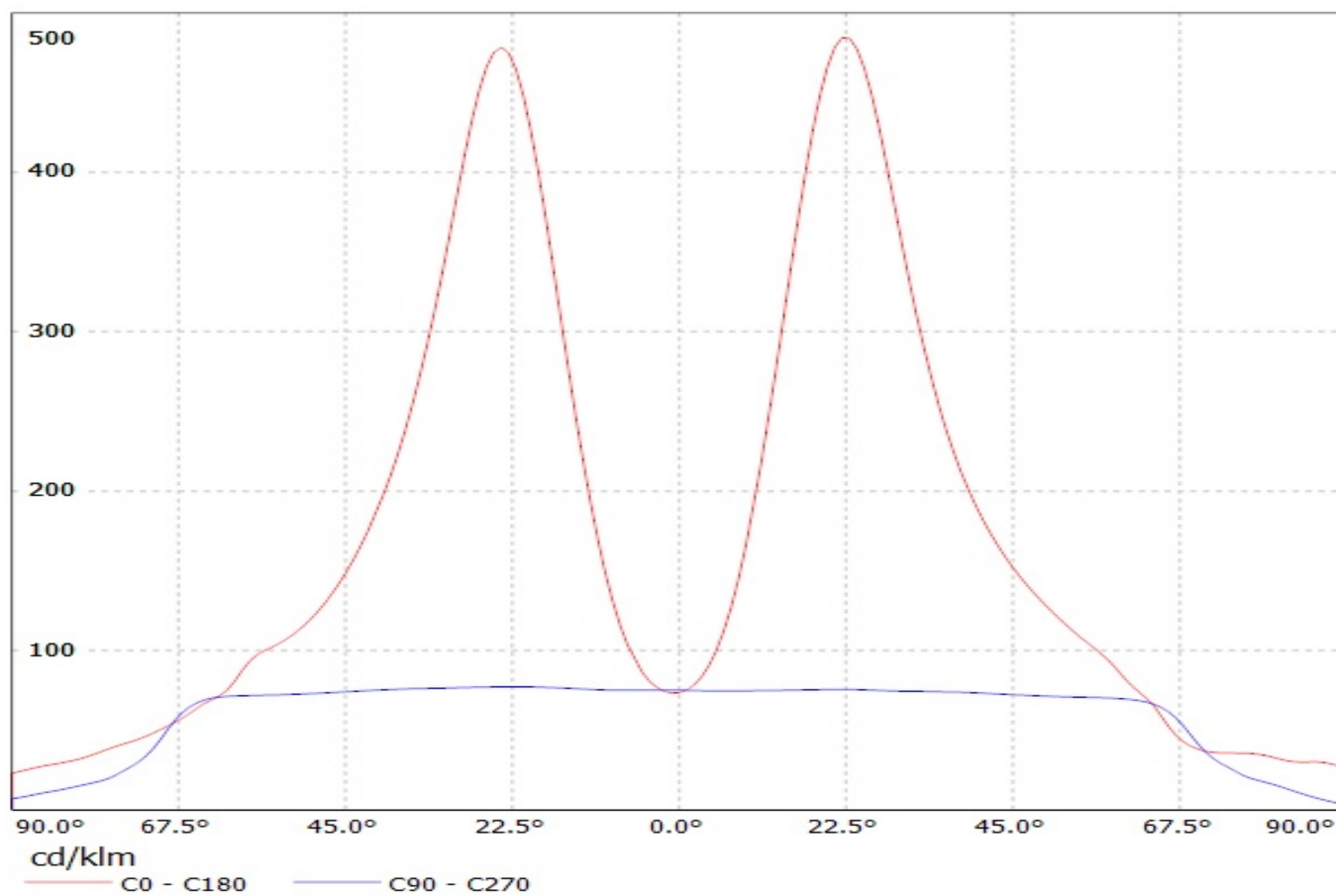



Luminaire: LEDiL Oy F14170\_FLORENCE-ZT25\_(Osram\_PLG2-BAR)

Lamps: 1 x Osram\_PLG2-BAR -1100-830-280x55-DC\_1021.93lm@225mA\_P=7.1643W\_I=0.225A

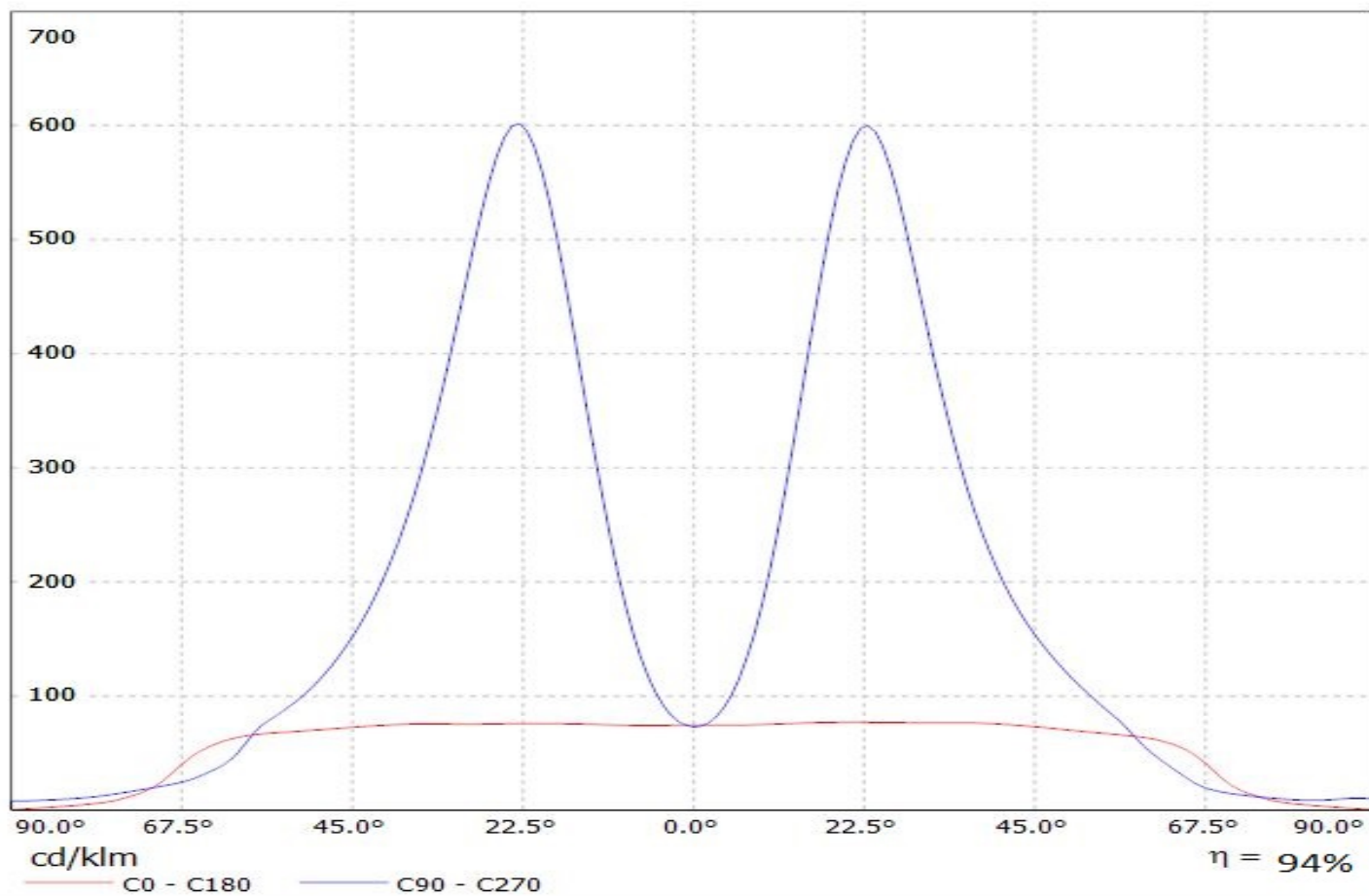

Luminaire: Ledil F14170\_FLORENCE-ZT25\_(Duris\_S2)  
Lamps: 1 x Osram\_Duris-S2\_3x11\_(GW\_SBLMA1.EM-GUHQ-XX37-L1N2)  
\_876.783lm@195mA\_CCT=3000K\_P=6.3082W\_I=0.195A

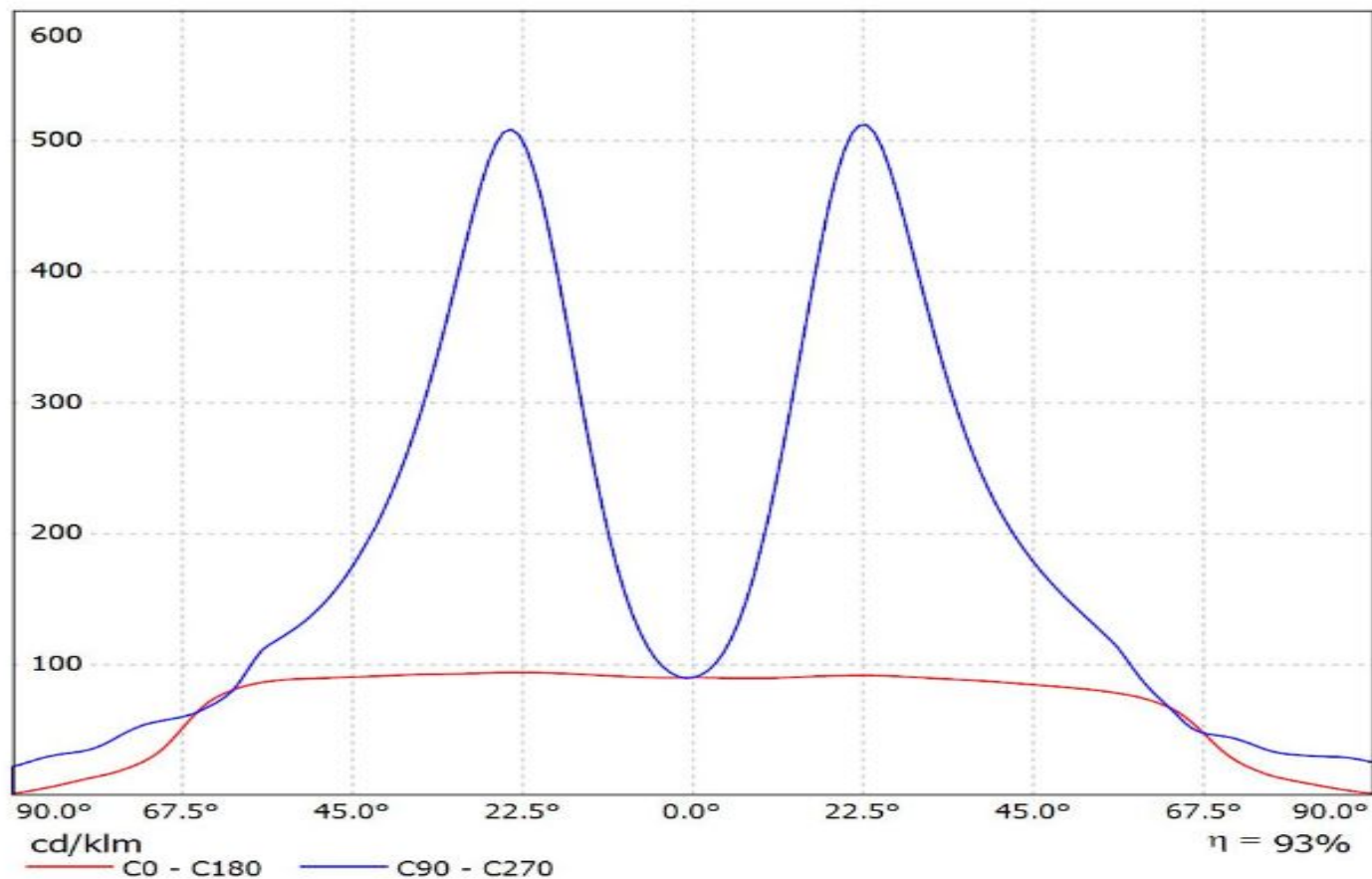

Luminaire: Ledil Oy F14170\_FLORENCE-ZT25\_(Duris\_E\_2835)\_SIMULATED  
Lamps: 1 x Osram Duris E 2835 - GW JTLRS1.EM

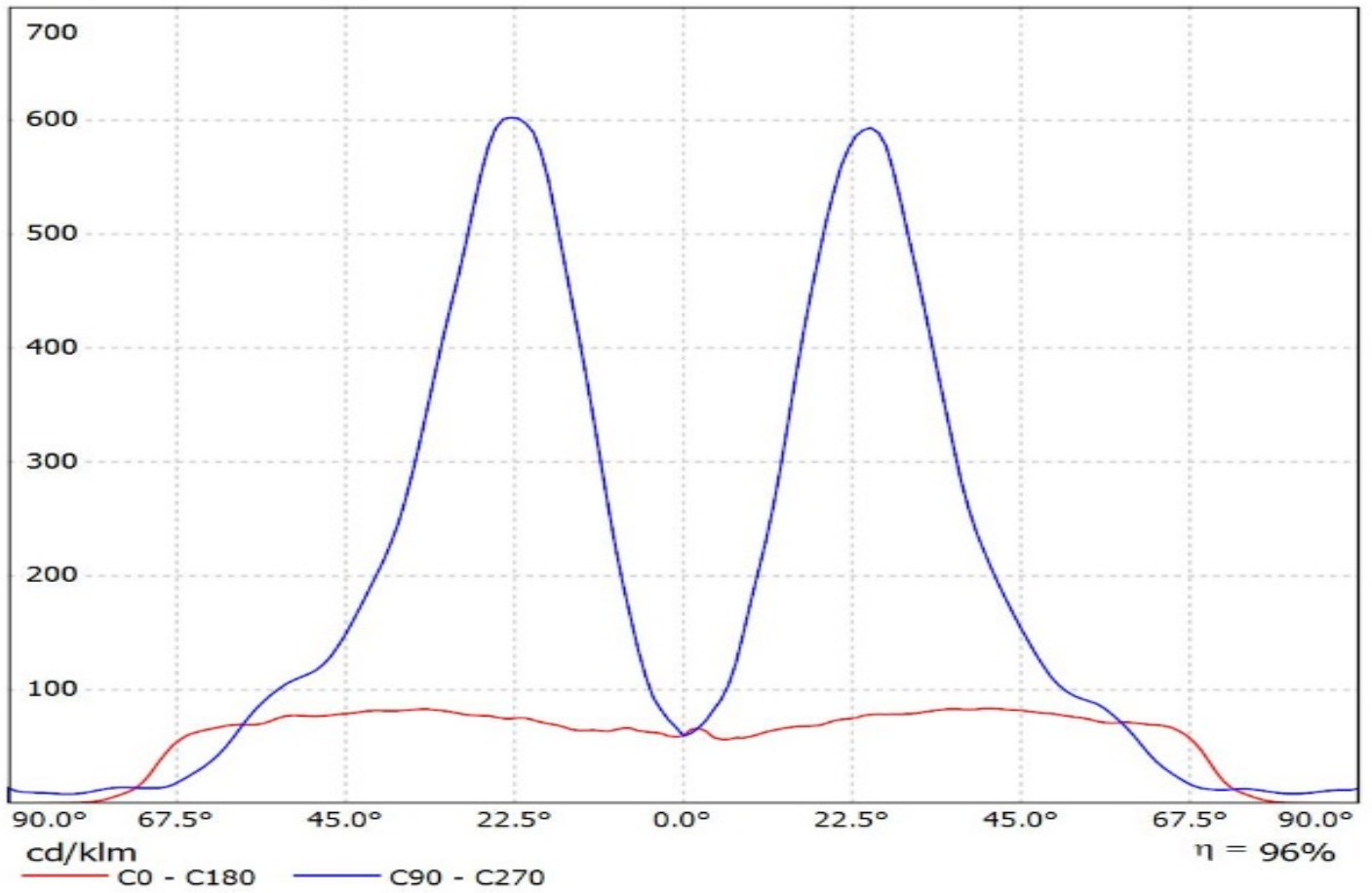

Luminaire: LEDiL Oy F14170\_FLORENCE-ZT25\_(Oslon\_Square\_Gen3)  
Lamps: 1 x Osram\_Oslon\_Square\_Gen3\_(GW\_CSSRM2.EM)  
\_1246.56lm@250mA\_P=7.4303W\_I=0.250A

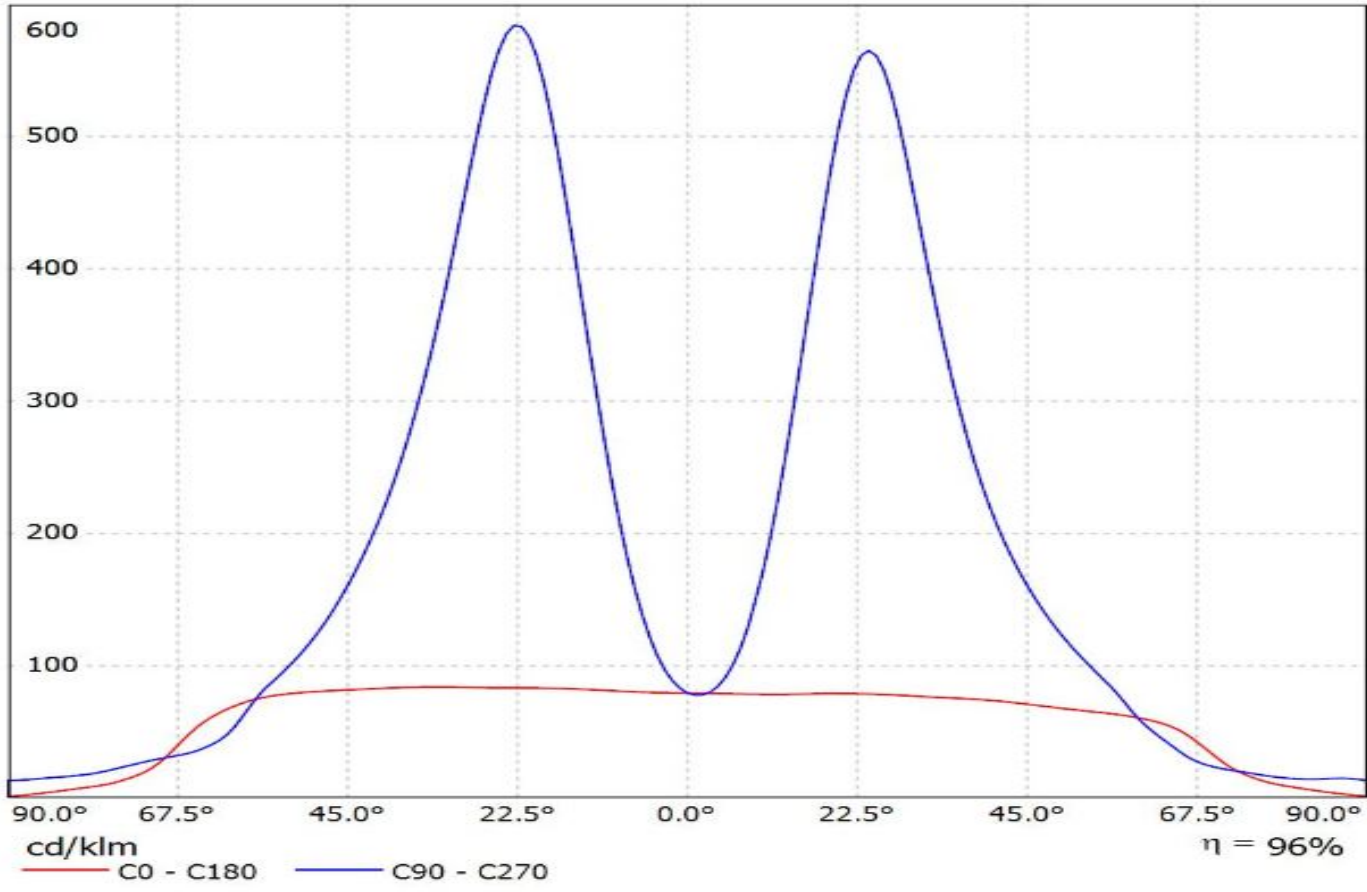

Luminaire: Ledil Oy F14170\_FLORENCE-ZT25-Fortimo\_650lm\_3R\_SIMULATED  
Lamps: 1 x Fortimo\_650lm\_3R

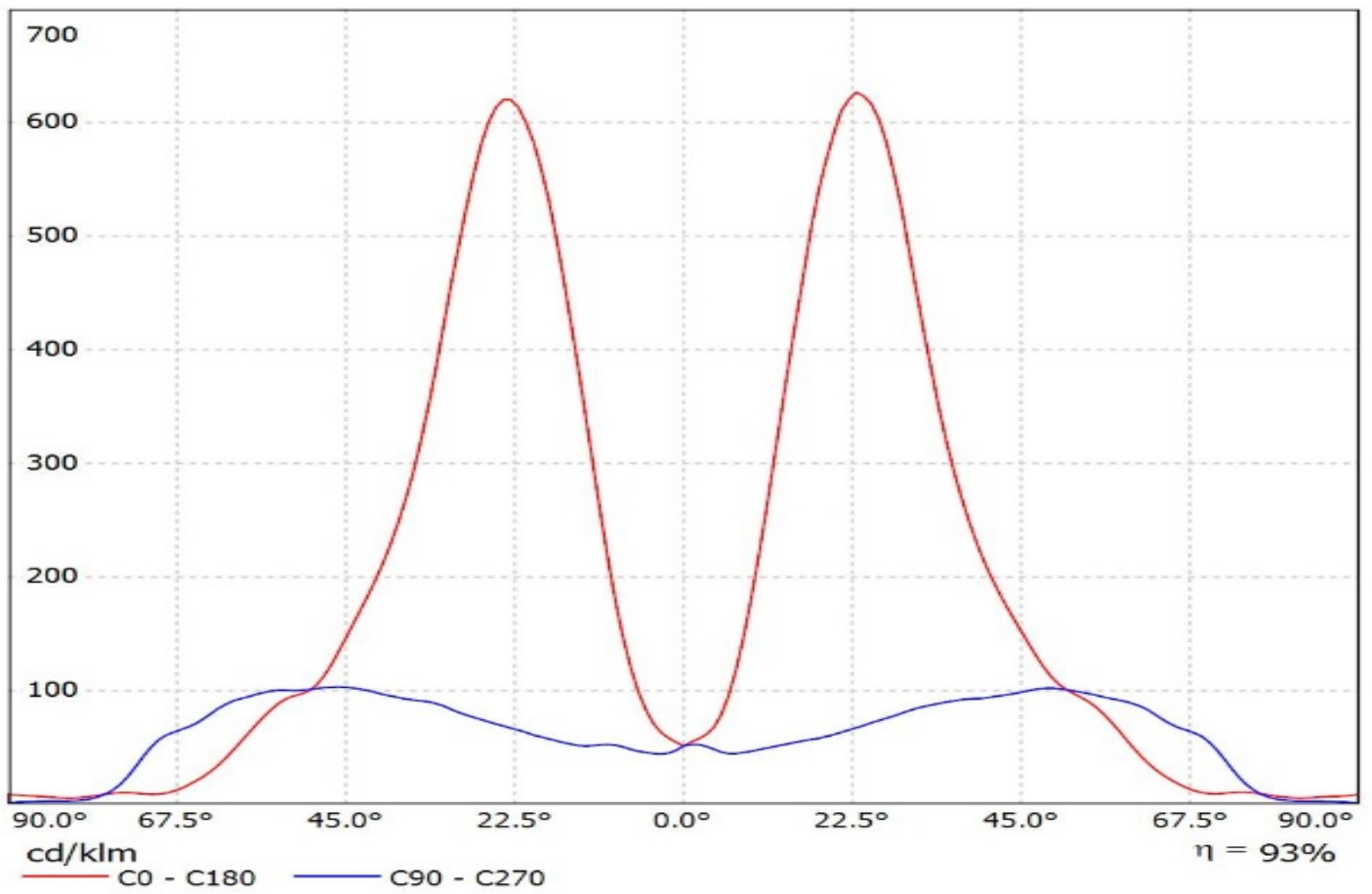

Luminaire: Ledil F14170\_FLORENCE-ZT25\_(Fortimo\_LED\_Line\_1ft\_2000lm\_8xx\_3R\_HV2)

Lamps: 1 x Fortimo\_LED\_Line\_1ft\_2000lm\_8xx\_3R\_HV2\_1229.9lm@250mA\_CCT=3000K\_P=7.5790W\_I=0.25A

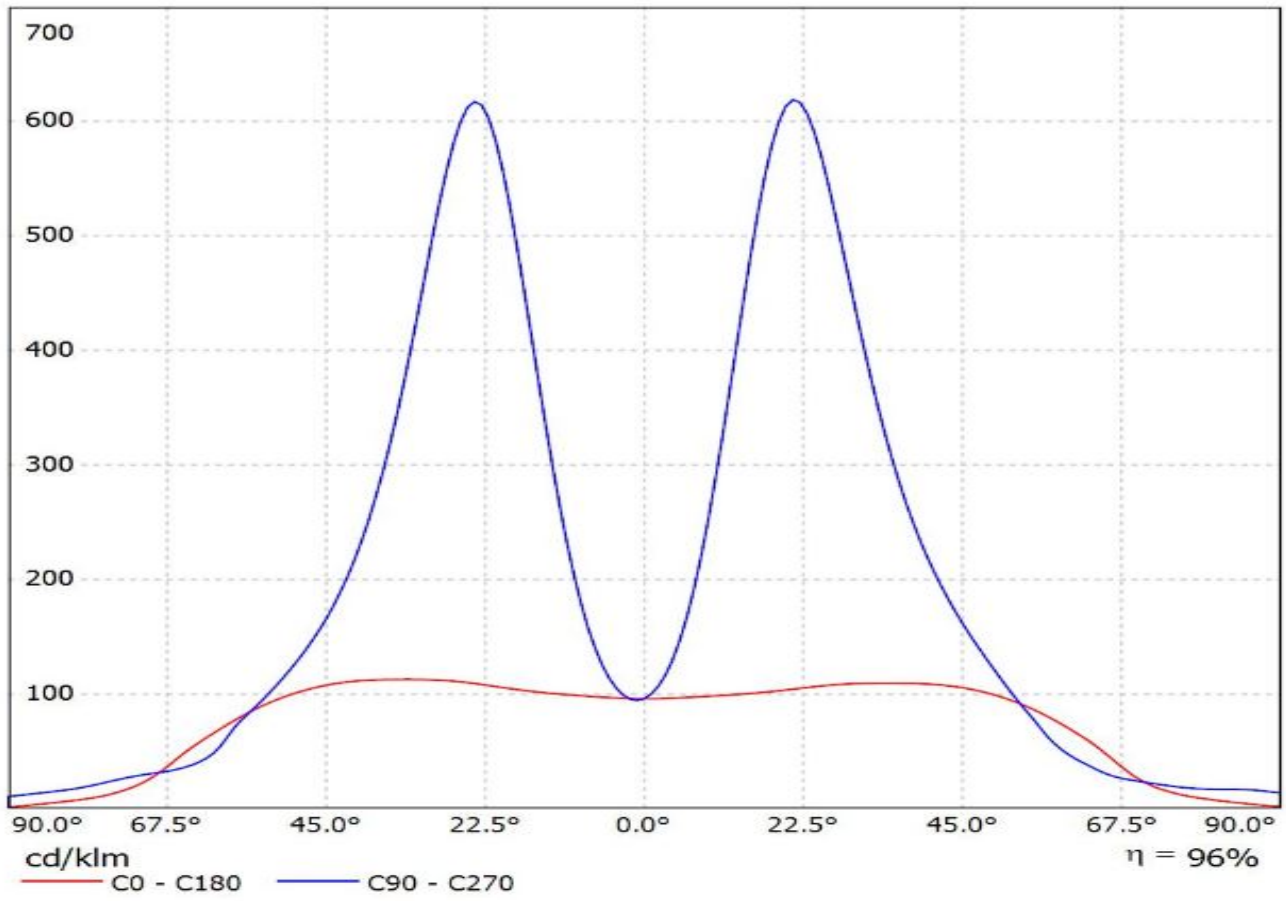

Luminaire: LEDiL Oy F14170\_FLORENCE-ZT25\_(LM561B) Eff: 94%  
Lamps: 1 x Samsung\_LM561B\_695.232lm@150mA\_P=4.6194W\_I=0.15A

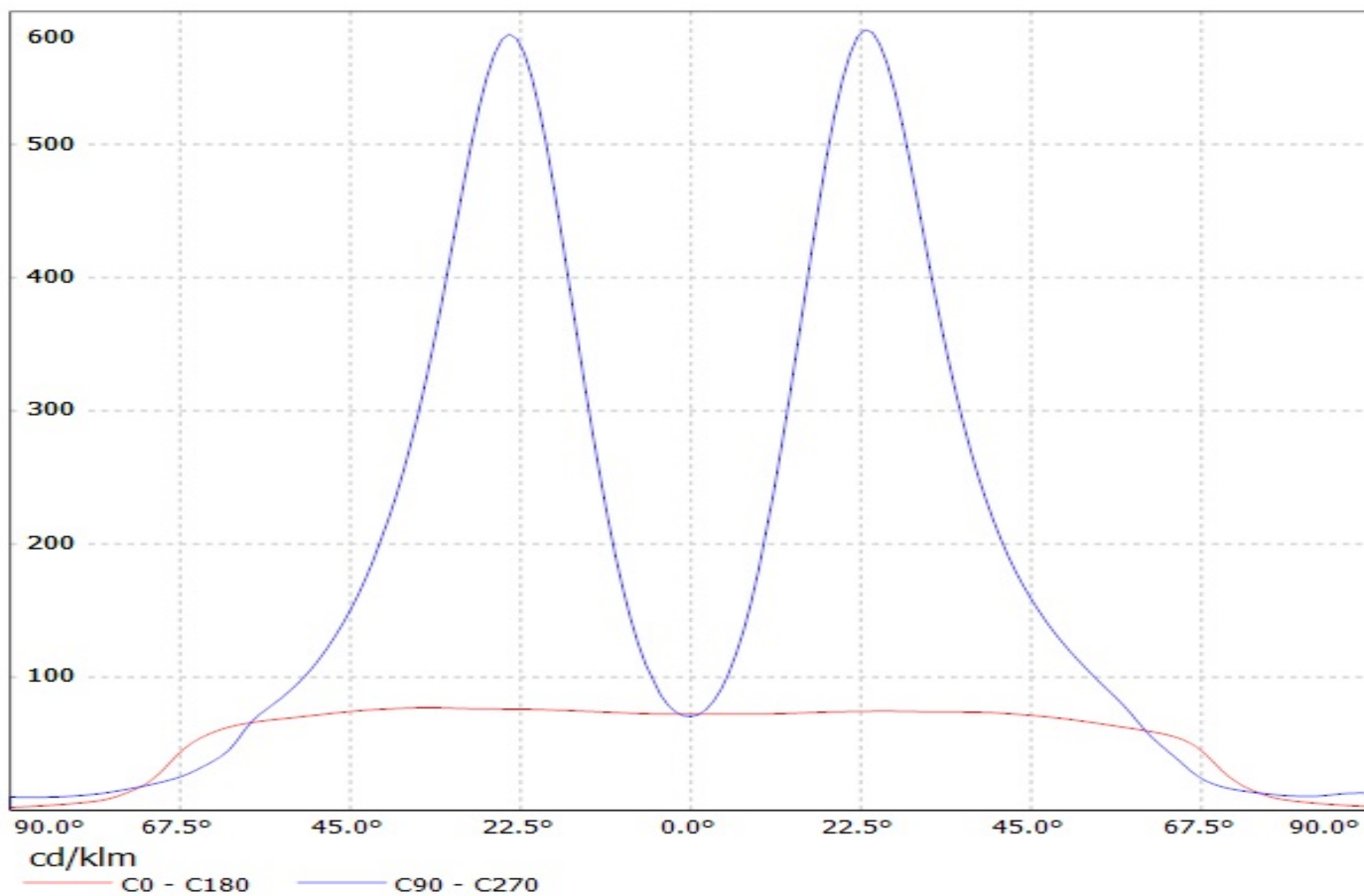

Luminaire: LEDiL Oy F14170\_FLORENCE-ZT25\_(LM231B) Eff: 94%  
Lamps: 1 x Samsung\_LM231B\_579lm@150mA\_P=4.62045W\_I=0.15A

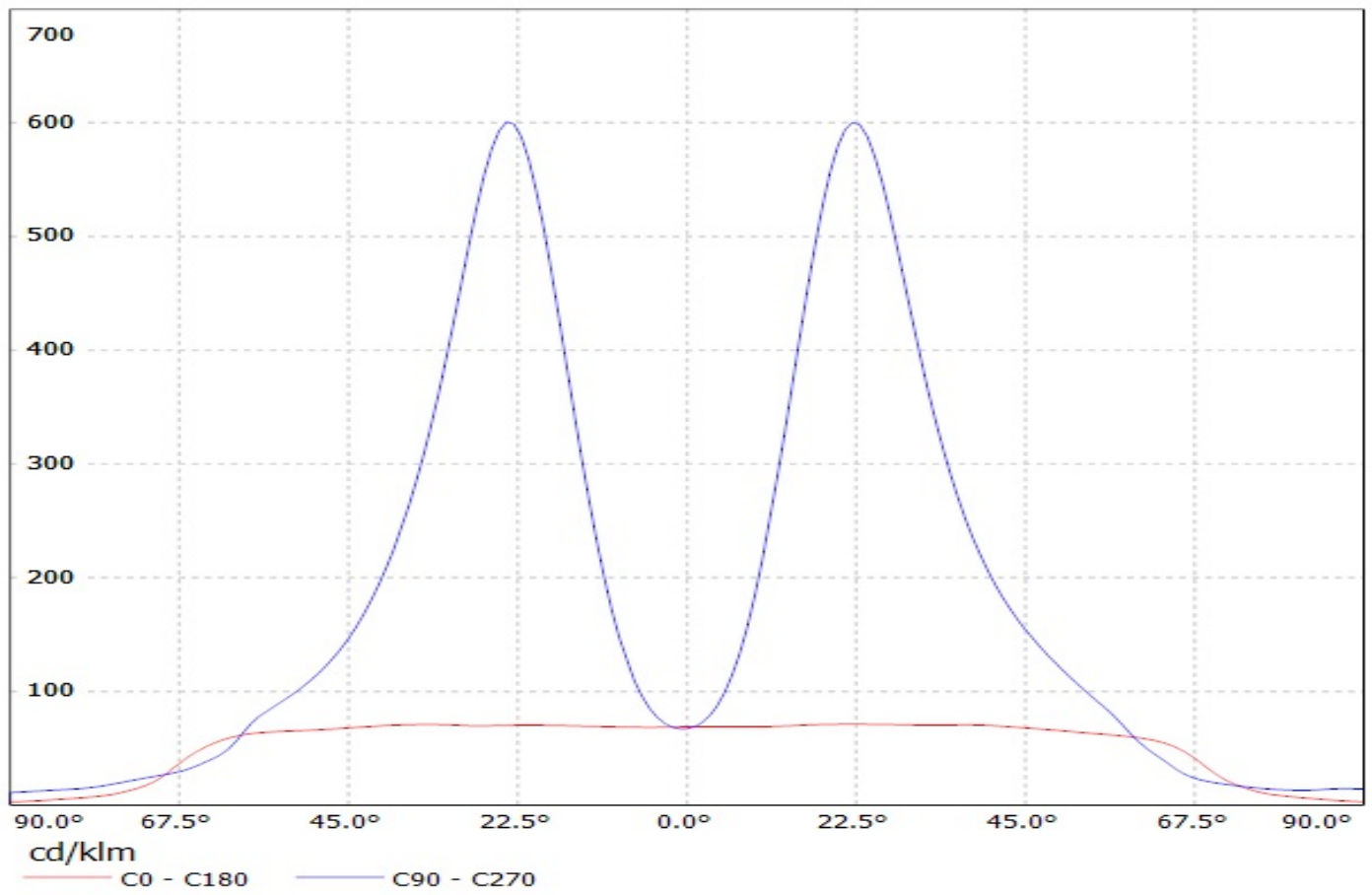



Luminaire: LEDiL Oy F14170\_FLORENCE-ZT25\_(LT-R286A)  
Lamps: 1 x Samsung\_LT-R286A\_1304.7lm@250mA\_P=8.2181W\_I=0.250A

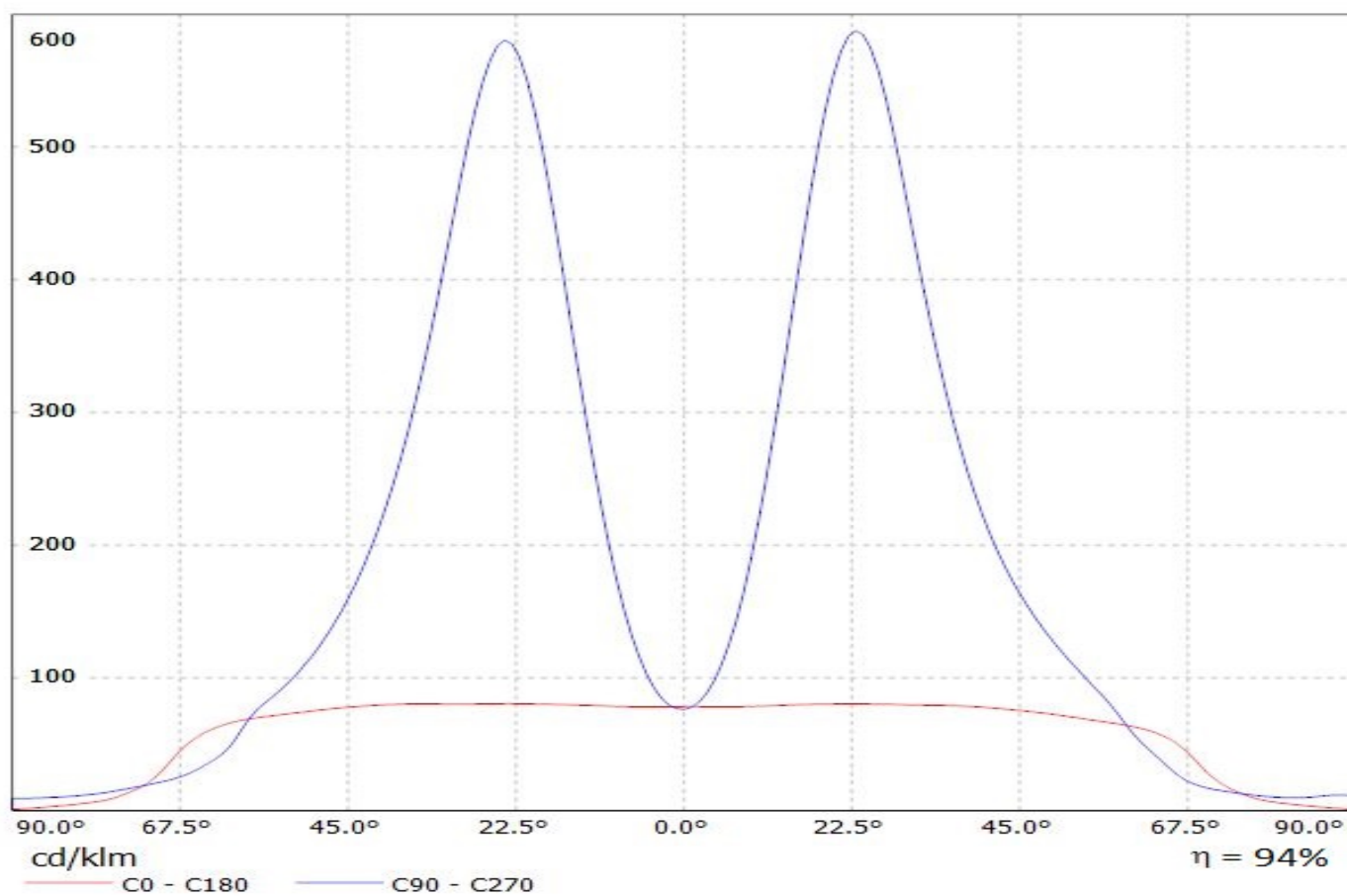

Luminaire: Ledil Oy F14170\_FLORENCE-ZT25\_(LM281B)\_SIMULATED  
Lamps: 1 x Samsung LM281B

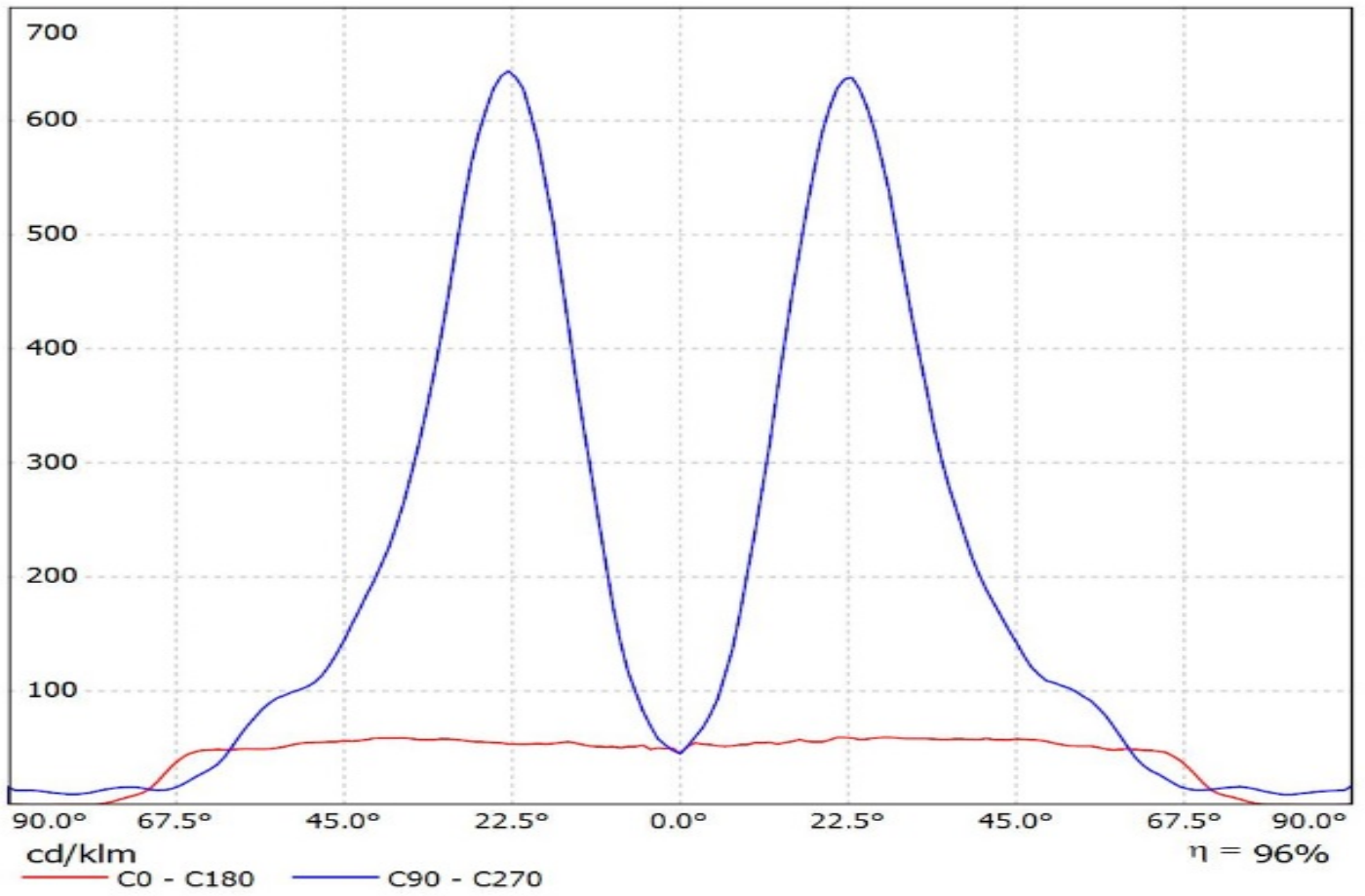

Luminaire: Ledil F14170\_FLORENCE-ZT25\_(LM561B+)

Lamps: 1 x Samsung\_LM561B+\_x33\_1261.92lm@250mA\_P=8.10375W\_U=32.415V

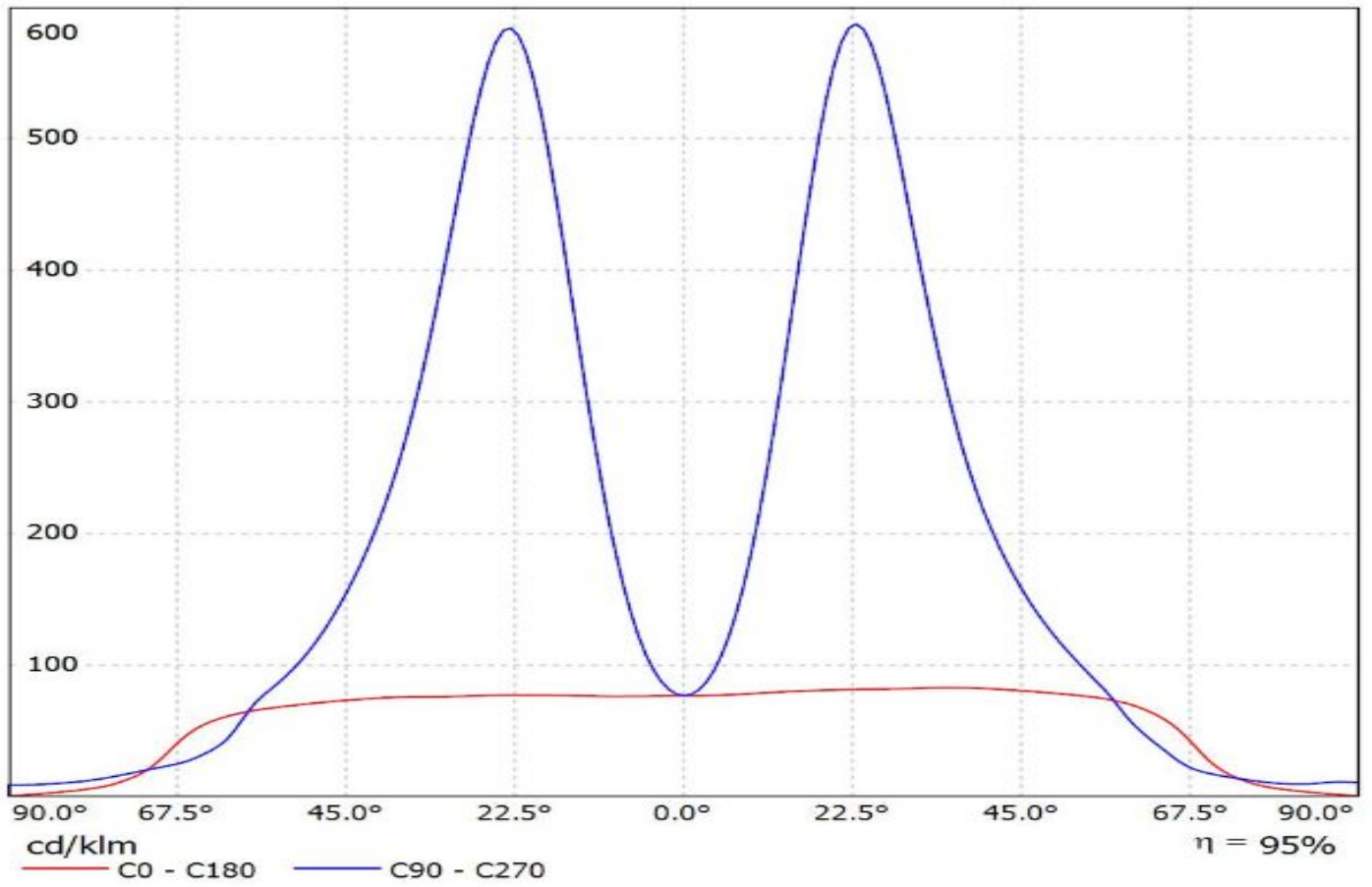

Luminaire: Ledil Oy F14170\_FLORENCE-ZT25\_OSRAM\_DURIS\_S5\_(2chip)\_SIMULATED  
Lamps: 1 x OSRAM DURIS S5 (2chip)

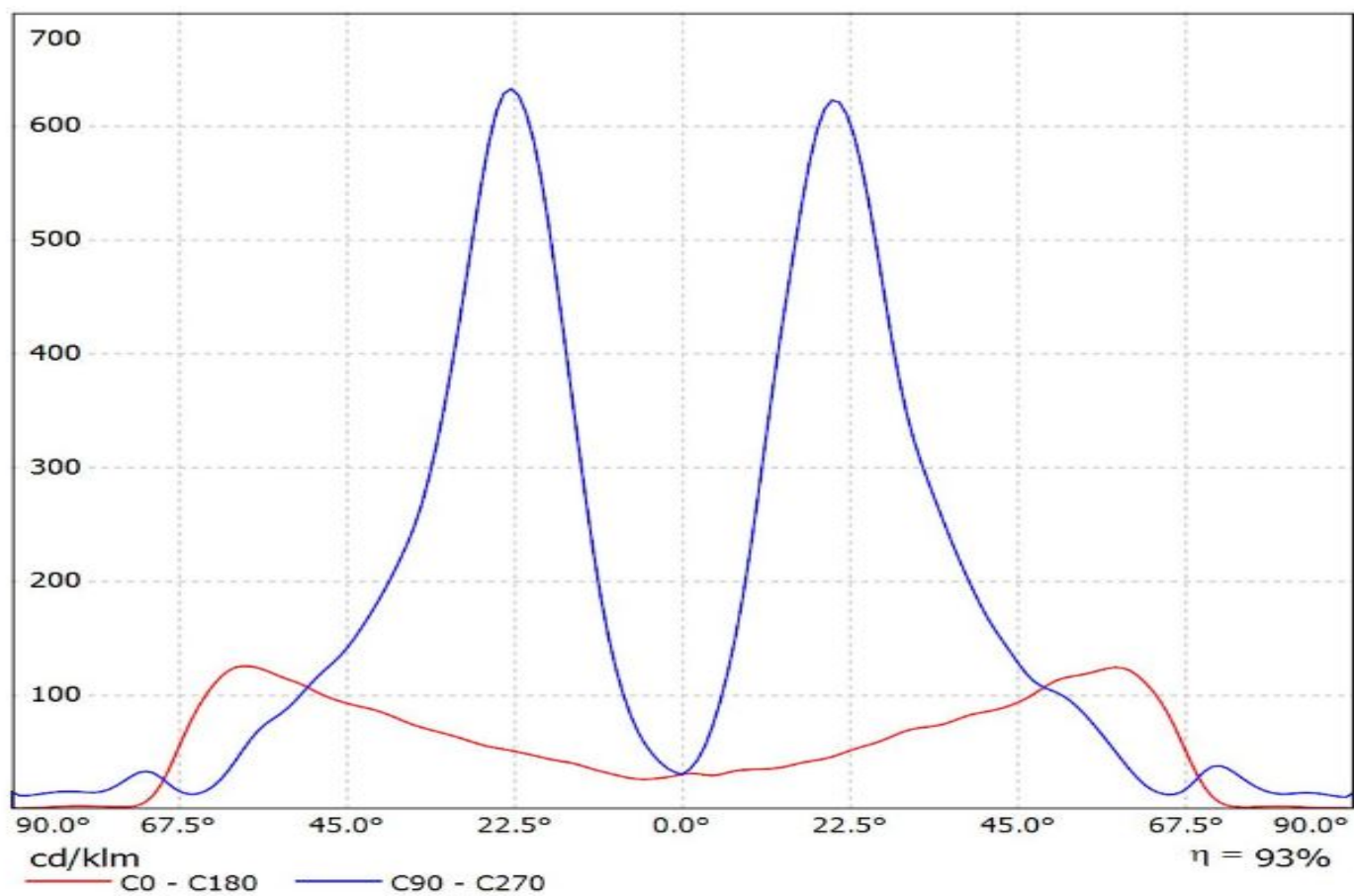

Luminaire: Ledil Oy F14170\_FLORENCE-ZT25\_SEOUL\_5630\_D\_SIMULATED  
Lamps: 1 x SEOUL 5630 D

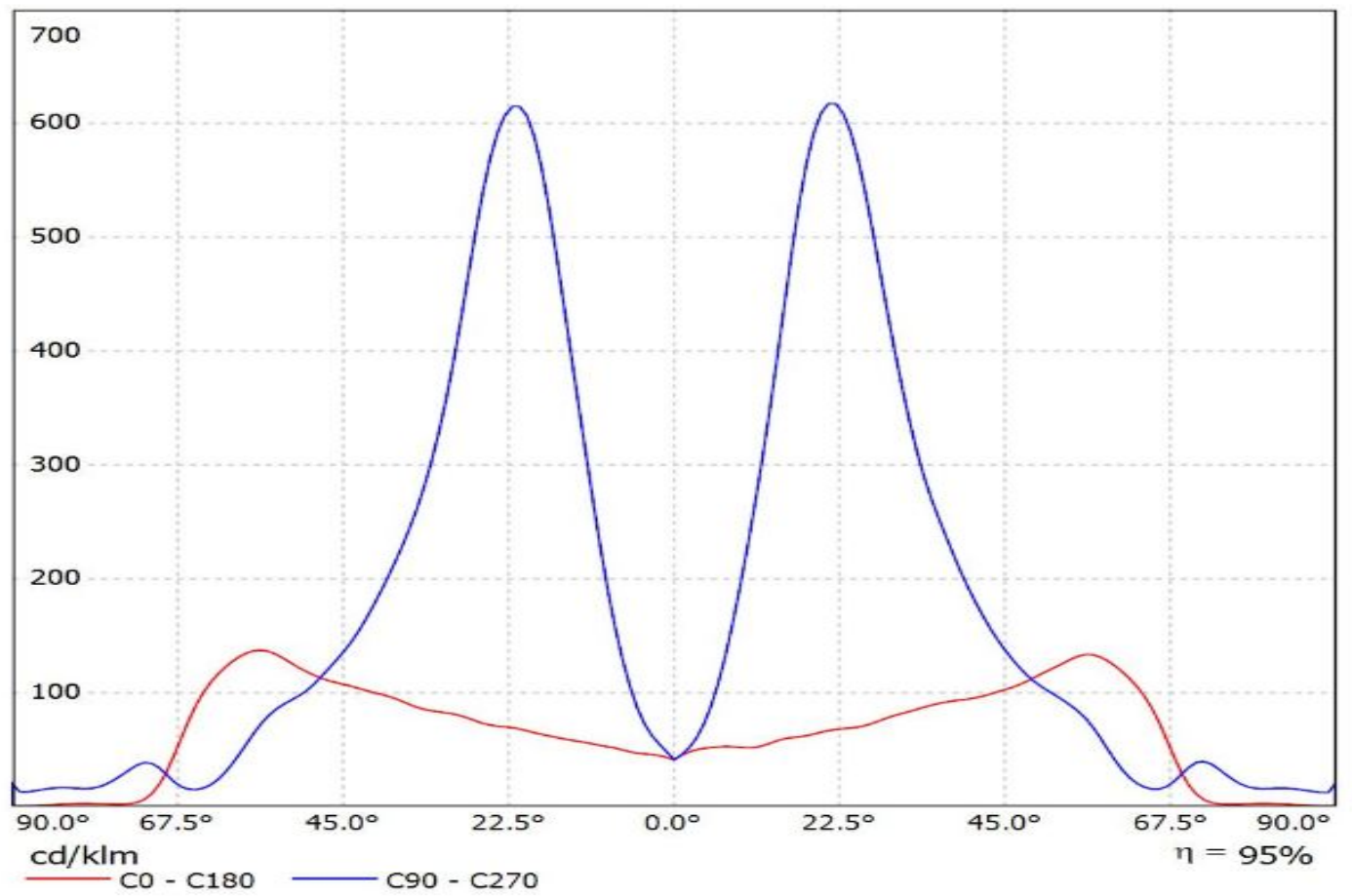

Luminaire: LEDiL Oy F14170\_FLORENCE-ZT25\_(LLE-55-280-1650)

Lamps: 1 x Tridonic\_STARK\_LLE-55-280-1650\_(STARK\_LLE-55-280-1650-840-CLA)\_1532lm@325lm\_CCT=4000K\_P=10.1908W\_I=324.9mA

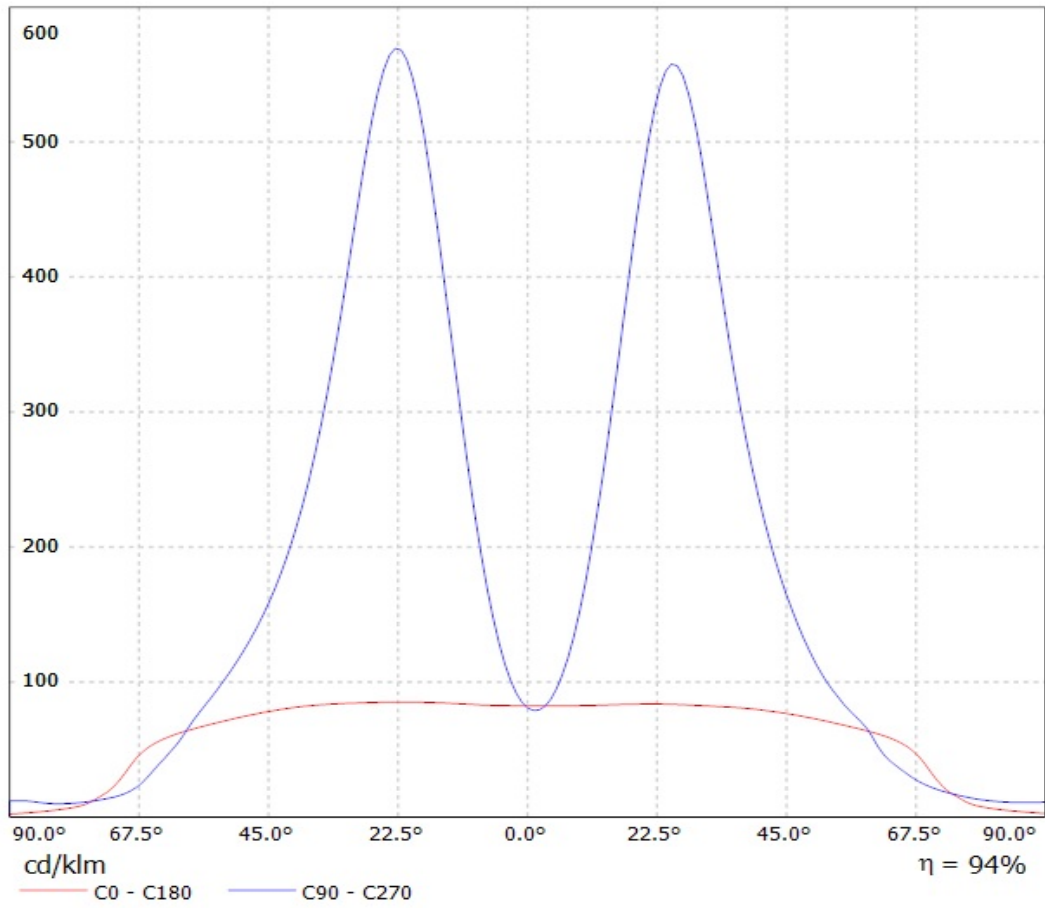

Luminaire: LEDiL Oy F14170\_FLORENCE-ZT25\_(AVAGO 5630 0.5W)  
Lamps: 1 x AVAGO ASMU-LWG0-NxxxE 1677.82lm@420mA 34.8V

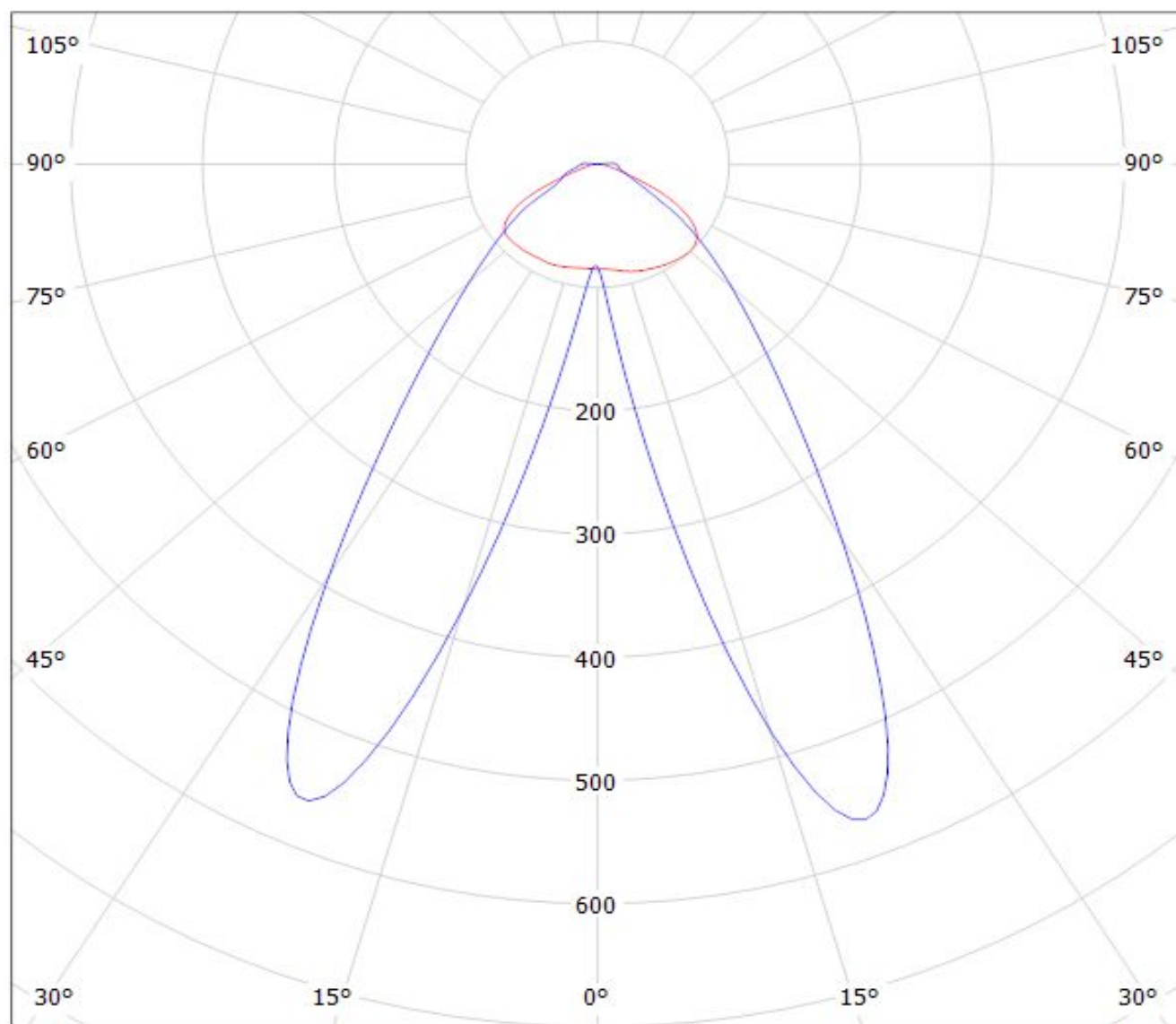

cd/klm

— C0 - C180 — C90 - C270

$\eta = 94\%$

Luminaire: LEDiL Oy F14170\_FLORENCE-ZT25\_(TRIDINO-R3)\_GS

Lamps: 1 x Comet\_Electronic sin\_TRIDINO-R3-8x0-1100-1ft-HV\_1299.6lm@250mA\_P=8.07304W\_I=0.250A

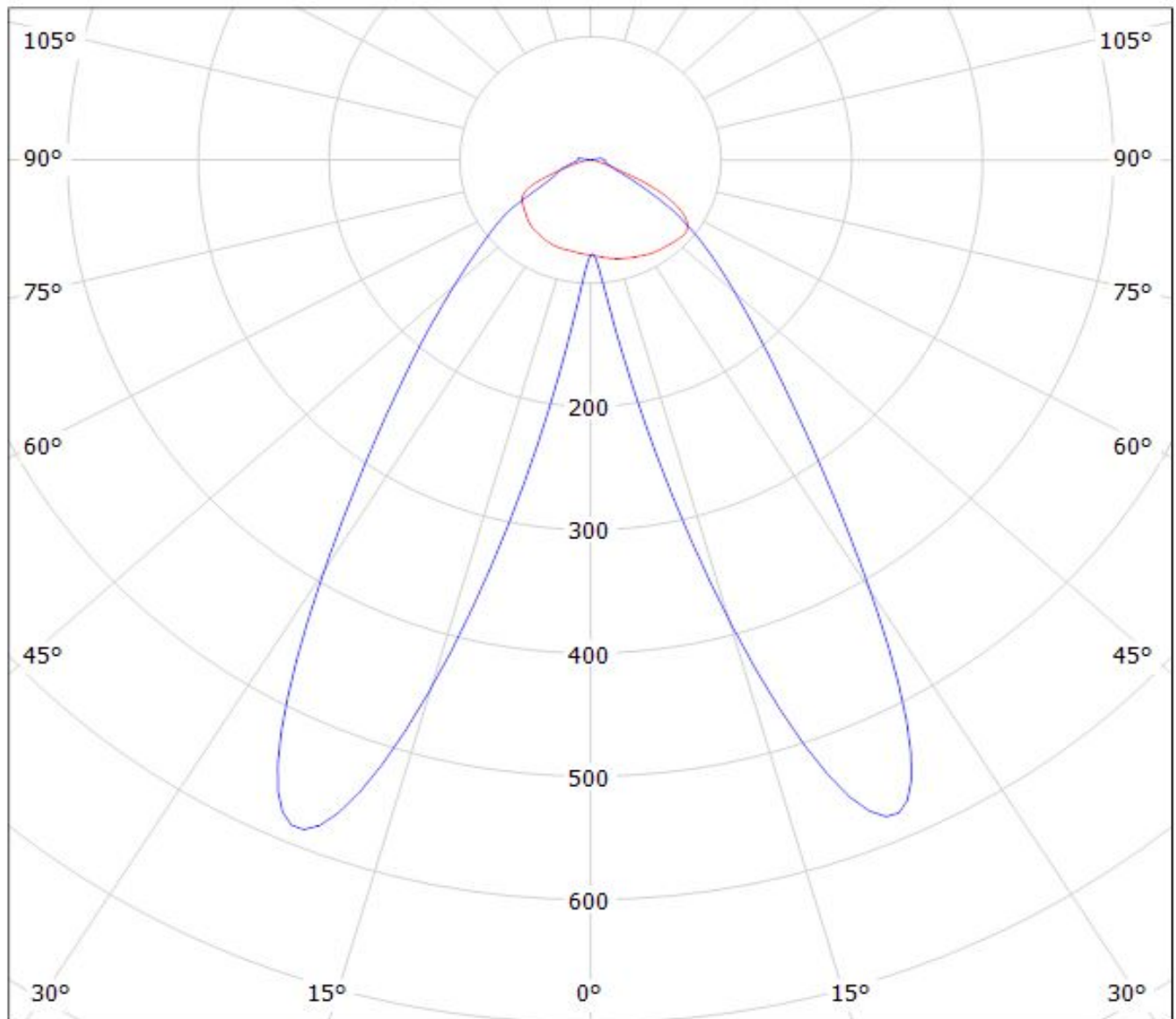

cd/klm

$\eta = 94\%$

— C0 - C180

— C90 - C270



Luminaire: LEDiL Oy F14170\_FLORENCE-ZT25\_(XH-G) Eff: 93%

Lamps: 1 x Cree\_XH-G\_(XHGAWT-0-7B4-J30-0H)\_1063.31lm@250mA\_P=8.12225W\_I=0.2498A

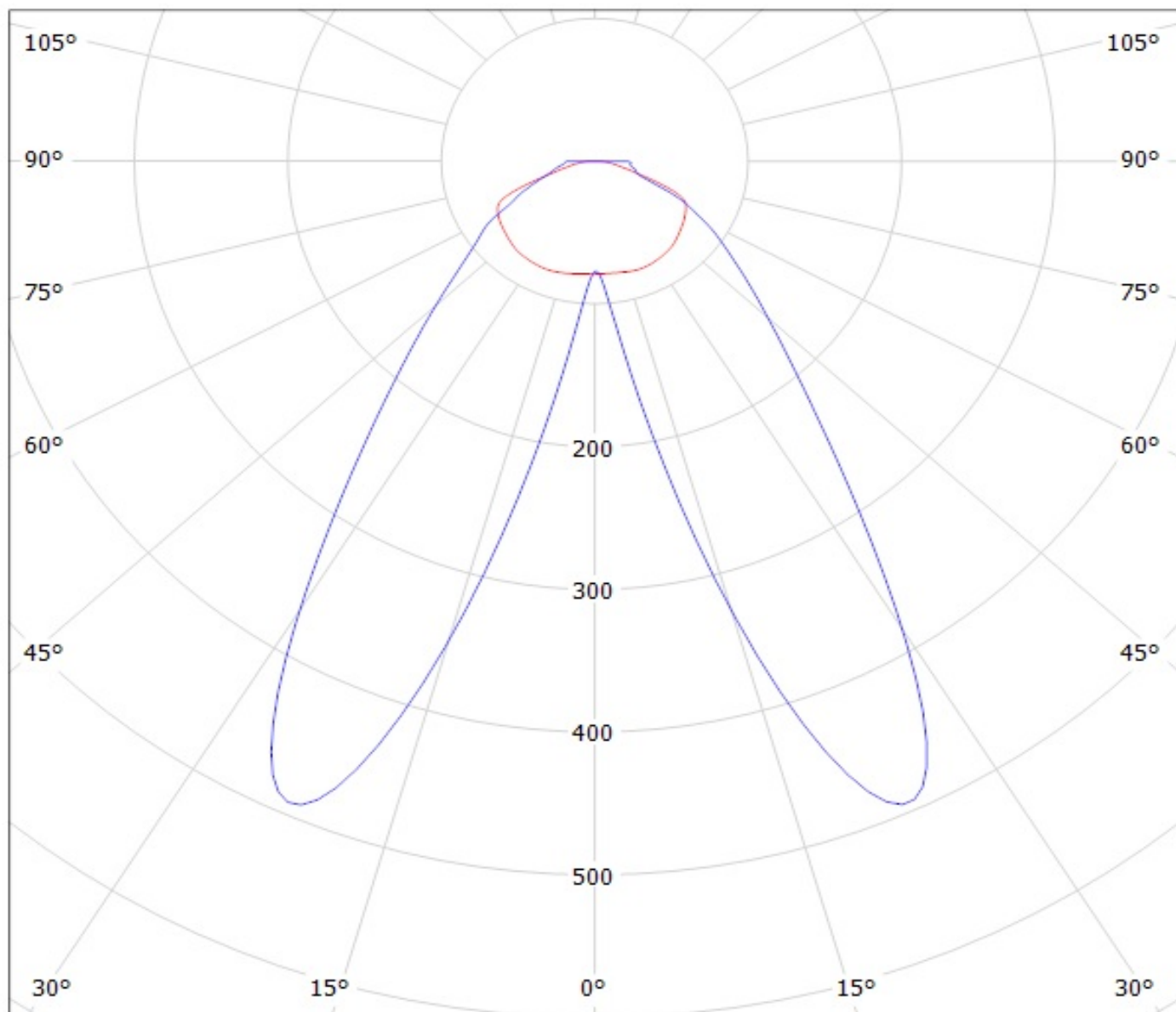

cd/klm

— C0 - C180    — C90 - C270

Luminaire: LEDiL Oy F14170\_FLORENCE-ZT25\_(LG\_5630)

Lamps: 1 x FLORENCE\_FORTIMO\_(LG\_5630)\_1000.68lm@250mA P=8.35483W I=250.7mA

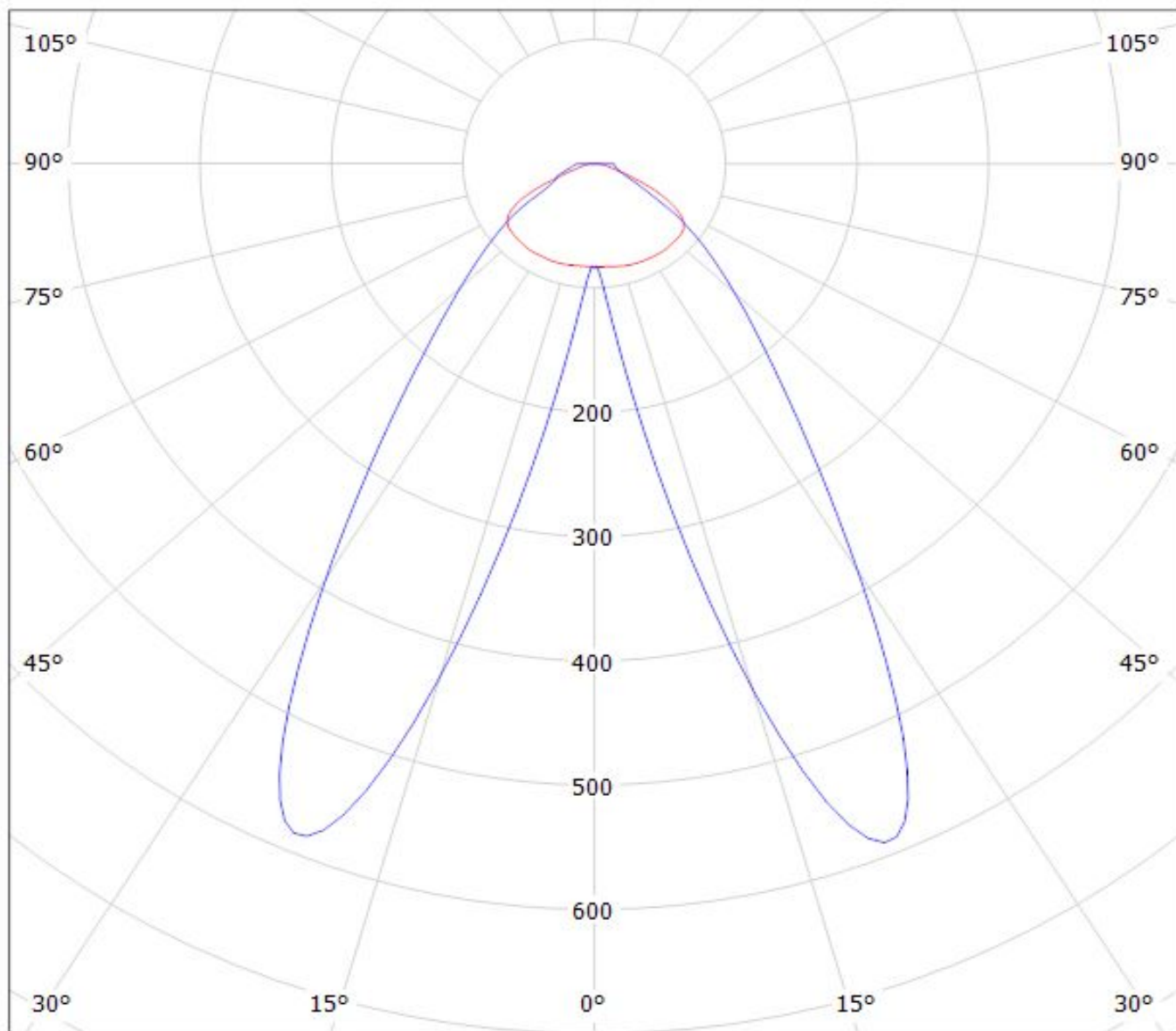

cd/klm

— C0 - C180

— C90 - C270

$\eta = 96\%$

Luminaire: LEDiL Oy F14170\_FLORENCE-ZT25\_(LG\_6030) Eff: 94%  
Lamps: 1 x LG\_6030\_(LEWMS68T80HZ)\_1082lm@250mA\_P=7.86385W\_I=0.2499A

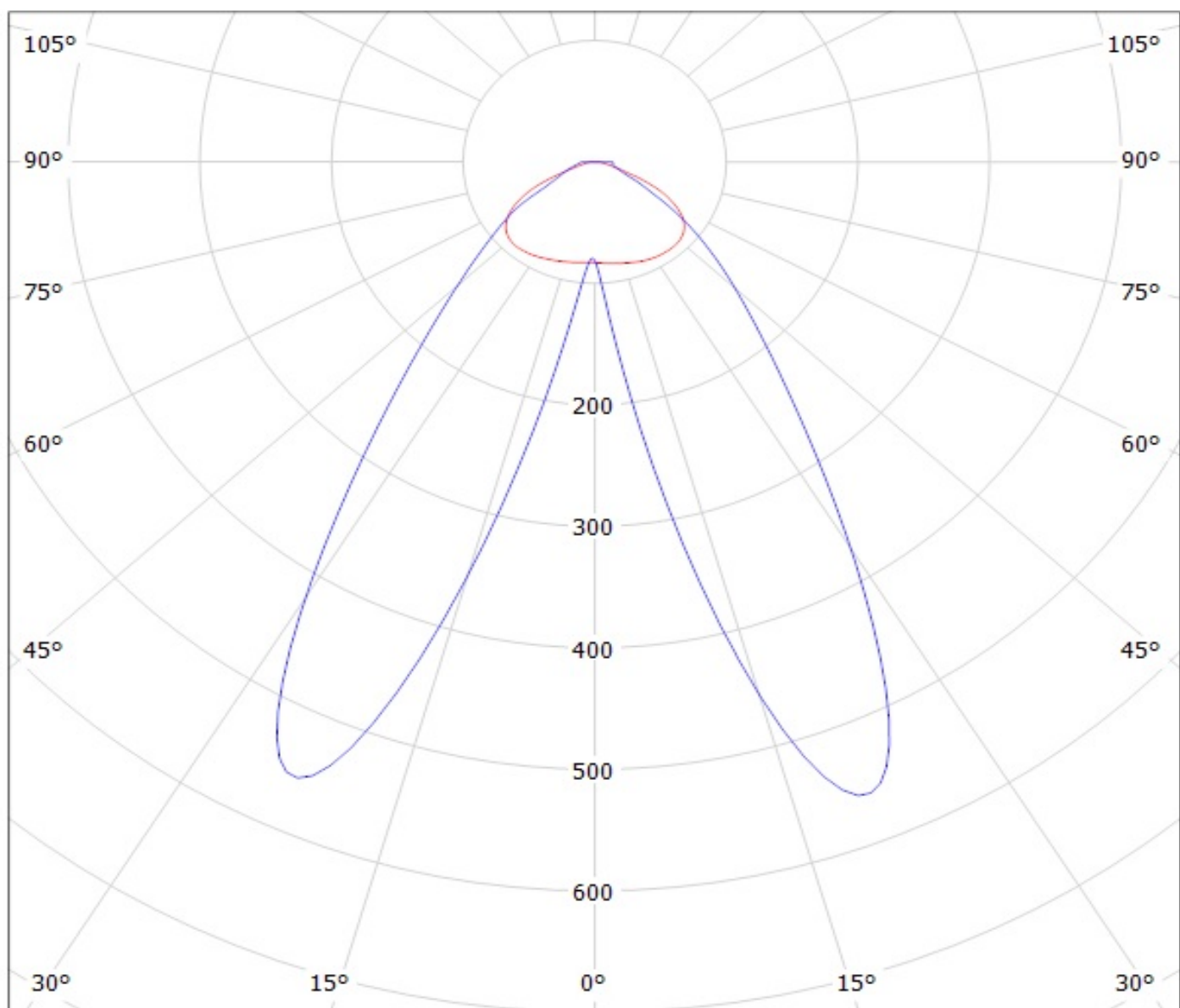

cd/klm

— C0 - C180

— C90 - C270

Luminaire: LEDiL Oy F14170\_FLORENCE-ZT25\_(Luxeon\_3535) Eff: 94%

Lamps: 1 x Luxeon\_3535\_2D\_(MXC8-PW40-0000)\_1516.52lm@200mA\_P=12.6909W\_I=0.1999A

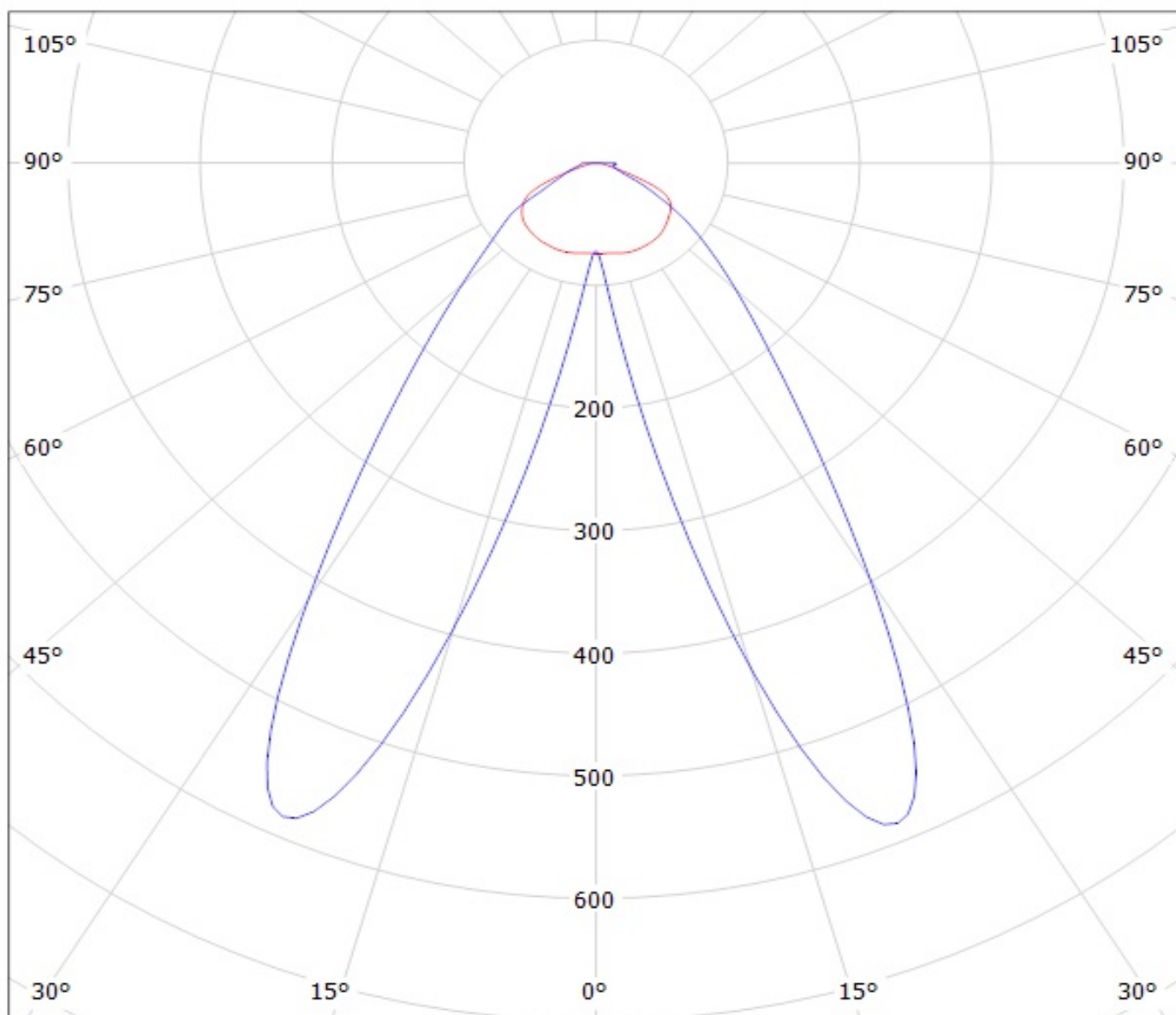

cd/klm

— C0 - C180

— C90 - C270

# Ledil F14170\_FLORENCE-ZT25\_(Luxeon\_3030\_2D) / LDC (Polar)

Luminaire: Ledil F14170\_FLORENCE-ZT25\_(Luxeon\_3030\_2D)

Lamps: 1 x Luxeon\_3030\_2D\_3x11\_(L130-4080003000W21)

\_1601.44lm@300mA\_CCT=4000K\_P=12.8W\_I=0.3A

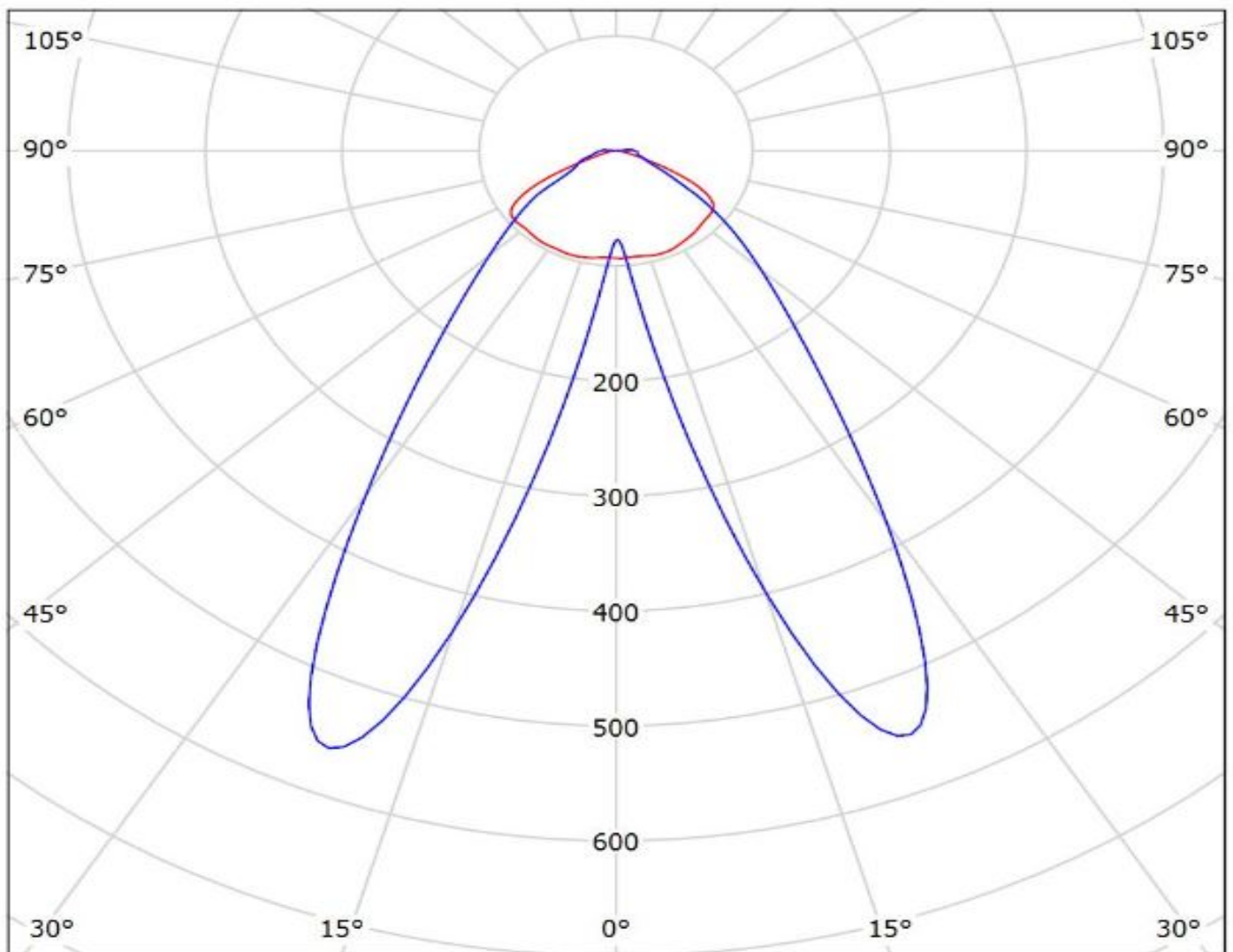

cd/klm

— C0 - C180 — C90 - C270

$\eta = 92\%$

# Ledil F14170\_FLORENCE-ZT25\_(Luxeon\_XR-3535L) / LDC (Polar)

Luminaire: Ledil F14170\_FLORENCE-ZT25\_(Luxeon\_XR-3535L)  
Lamps: 1 x Lumileds\_Luxeon\_XR-3535L\_3x11\_(L202-3080033C30001)  
\_1087.37lm@250mA\_CCT=3000K\_P=8.15W\_I=0.25A

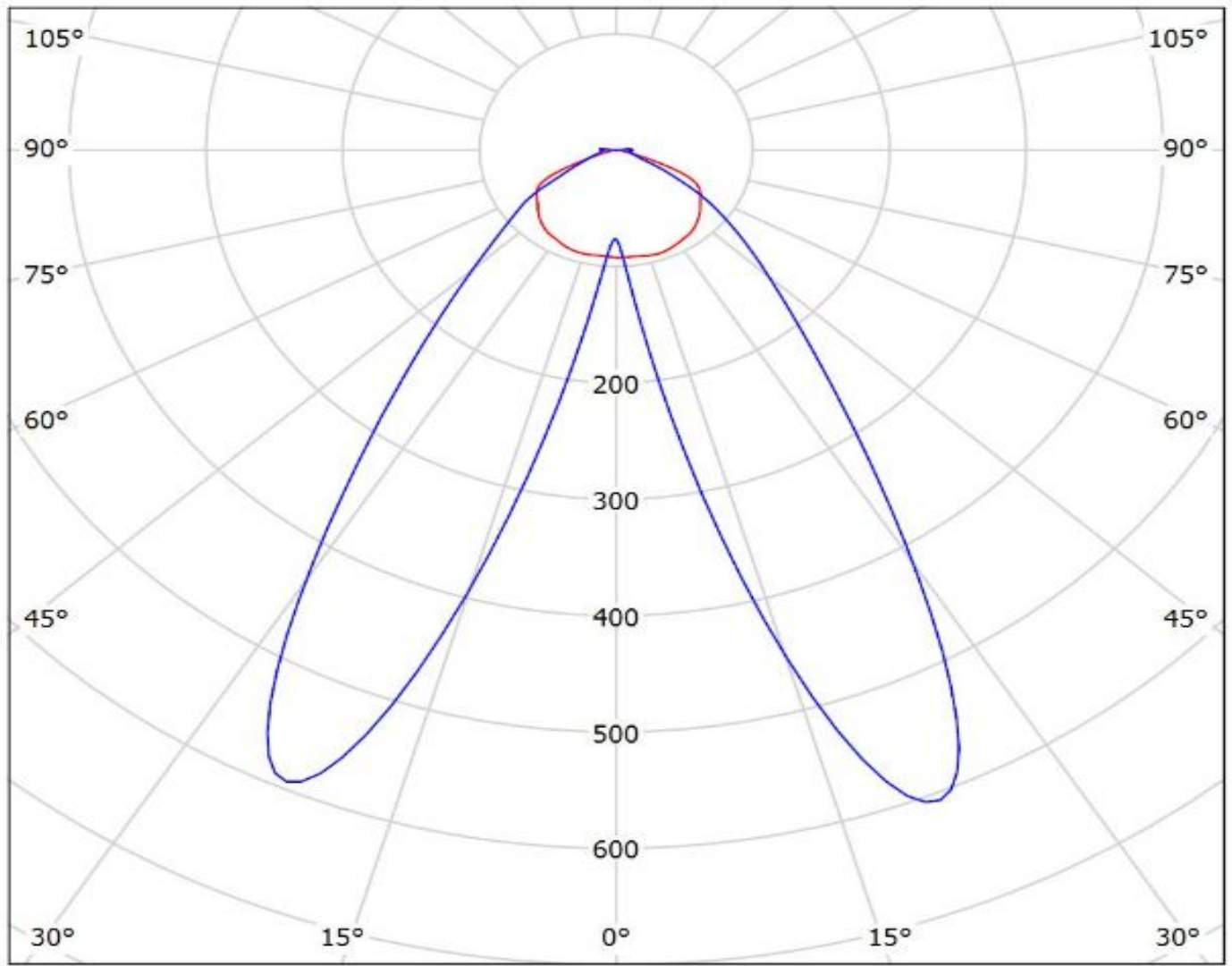

cd/klm  
— C0 - C180 — C90 - C270

$\eta = 97\%$

# Ledil F14170\_FLORENCE-ZT25\_(MP-2016) / LDC (Polar)

Luminaire: Ledil F14170\_FLORENCE-ZT25\_(MP-2016)

Lamps: 1 x Luminus\_MP-2016\_x22\_(LUMMP-1100-30-80)\_715.864lm@180mA\_P=6W\_I=0.18A

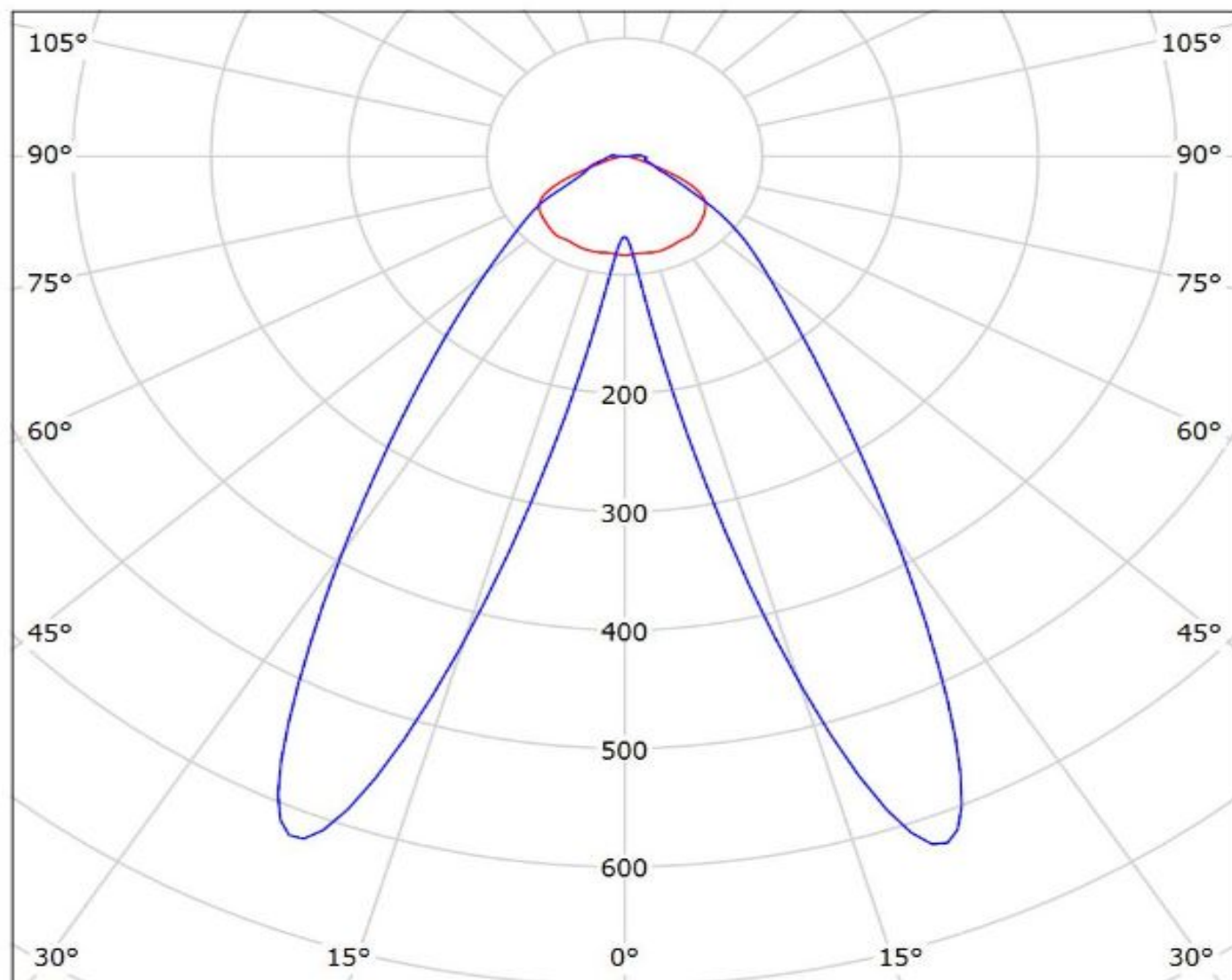

cd/klm

— C0 - C180

— C90 - C270

$\eta = 95\%$

Luminaire: LEDiL Oy F14170\_FLORENCE-ZT25\_(NT2x757D) Eff: 94%

Lamps: 1 x Nichia\_NT2x757D\_(NT2W757DRT)\_1465.4lm@150mA\_P=9.3849W\_I=0.15A

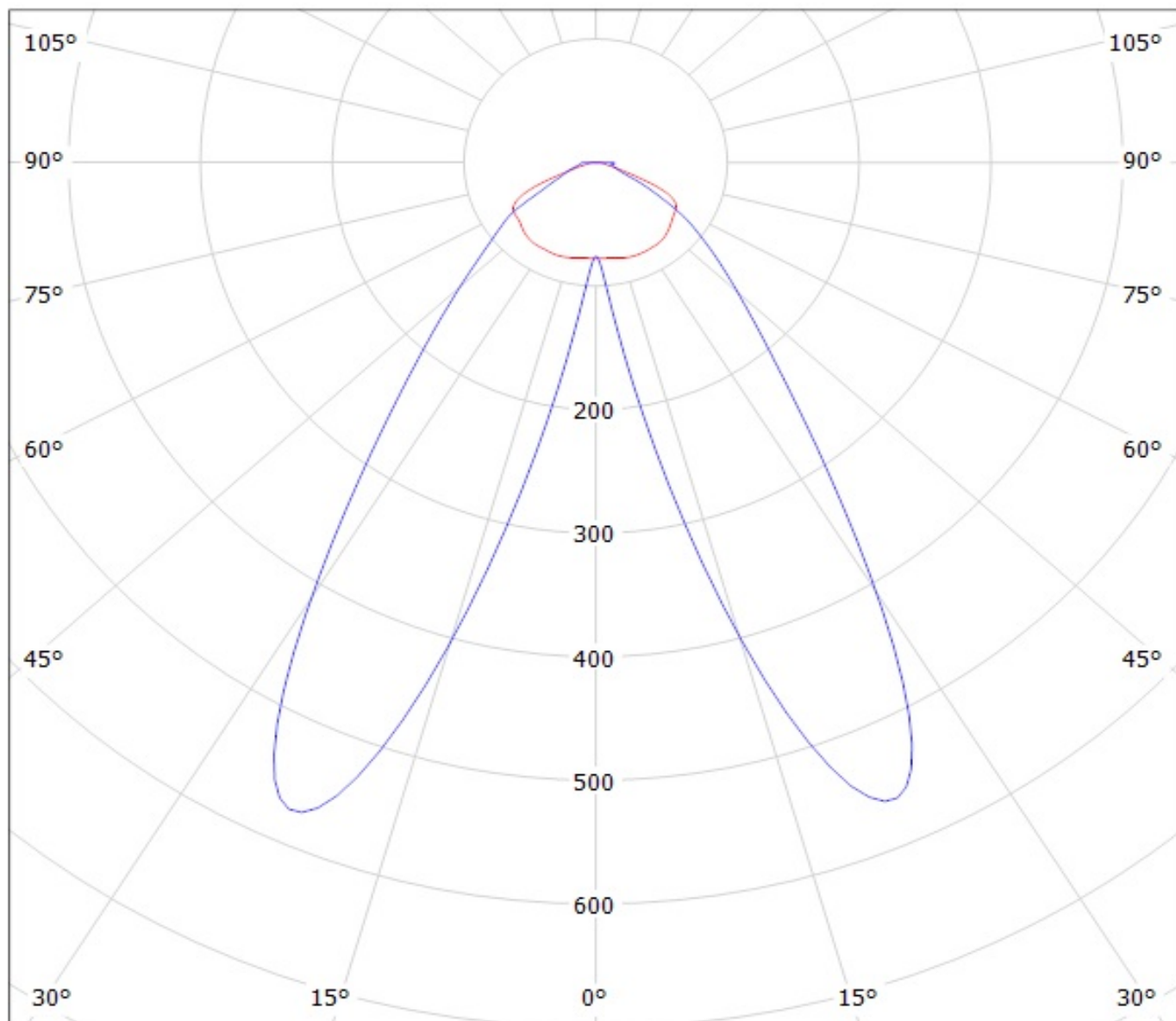

cd/klm

— C0 - C180

— C90 - C270



Luminaire: LEDiL Oy F14170\_FLORENCE-ZT25\_(DURIS\_E5) Eff. 94%  
Lamps: 1 x Osram\_DURIS\_E5\_570lm@120mA\_P=3.69459W\_I=120.2mA

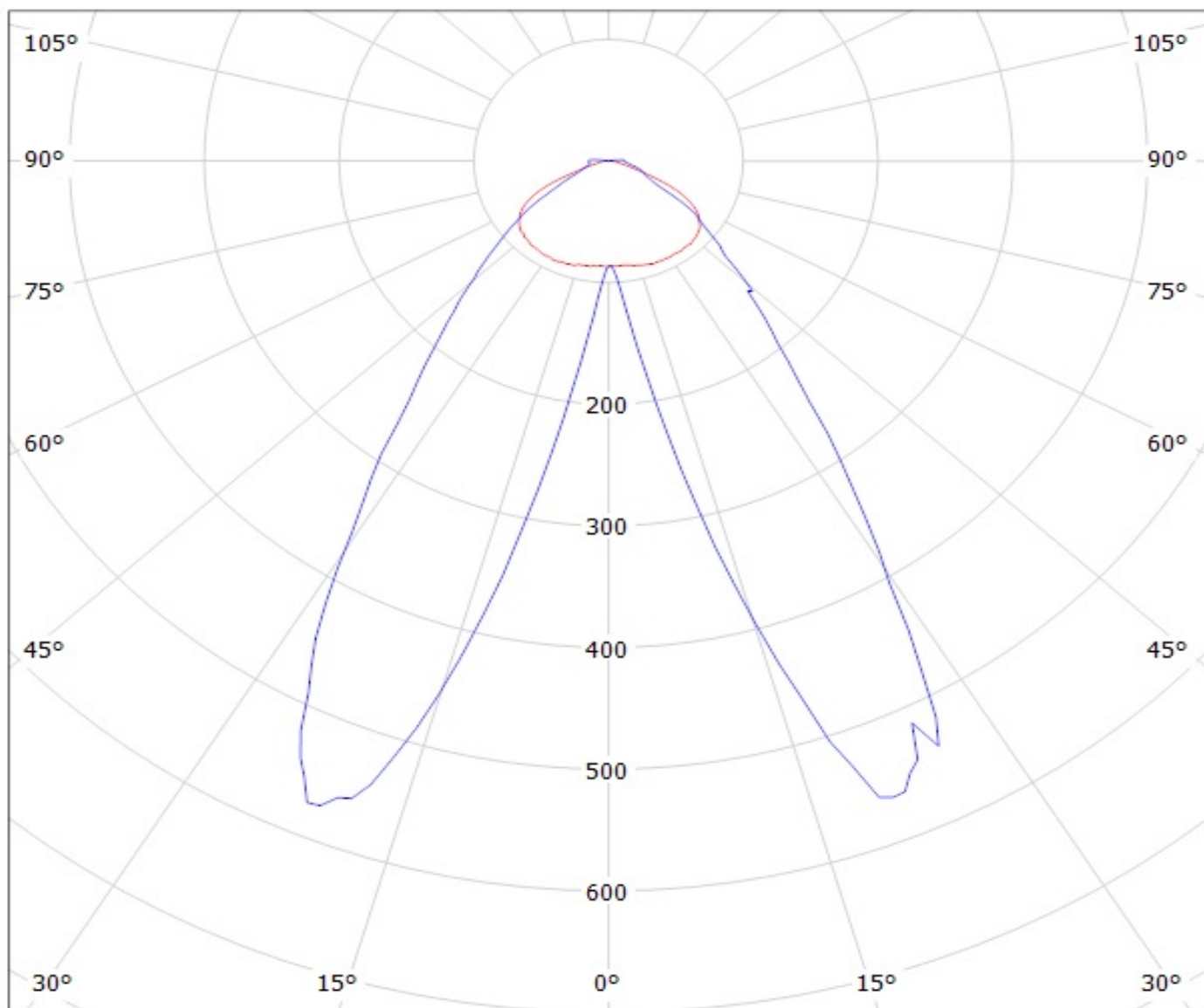

cd/klm

— C0 - C180

— C90 - C270

Luminaire: LEDiL Oy F14170\_FLORENCE-ZT25\_(DURIS\_S5) Eff: 94%  
Lamps: 1 x Osram\_DURIS\_S5\_511.3lm@120mA\_P=3.76574W\_I=120.1mA

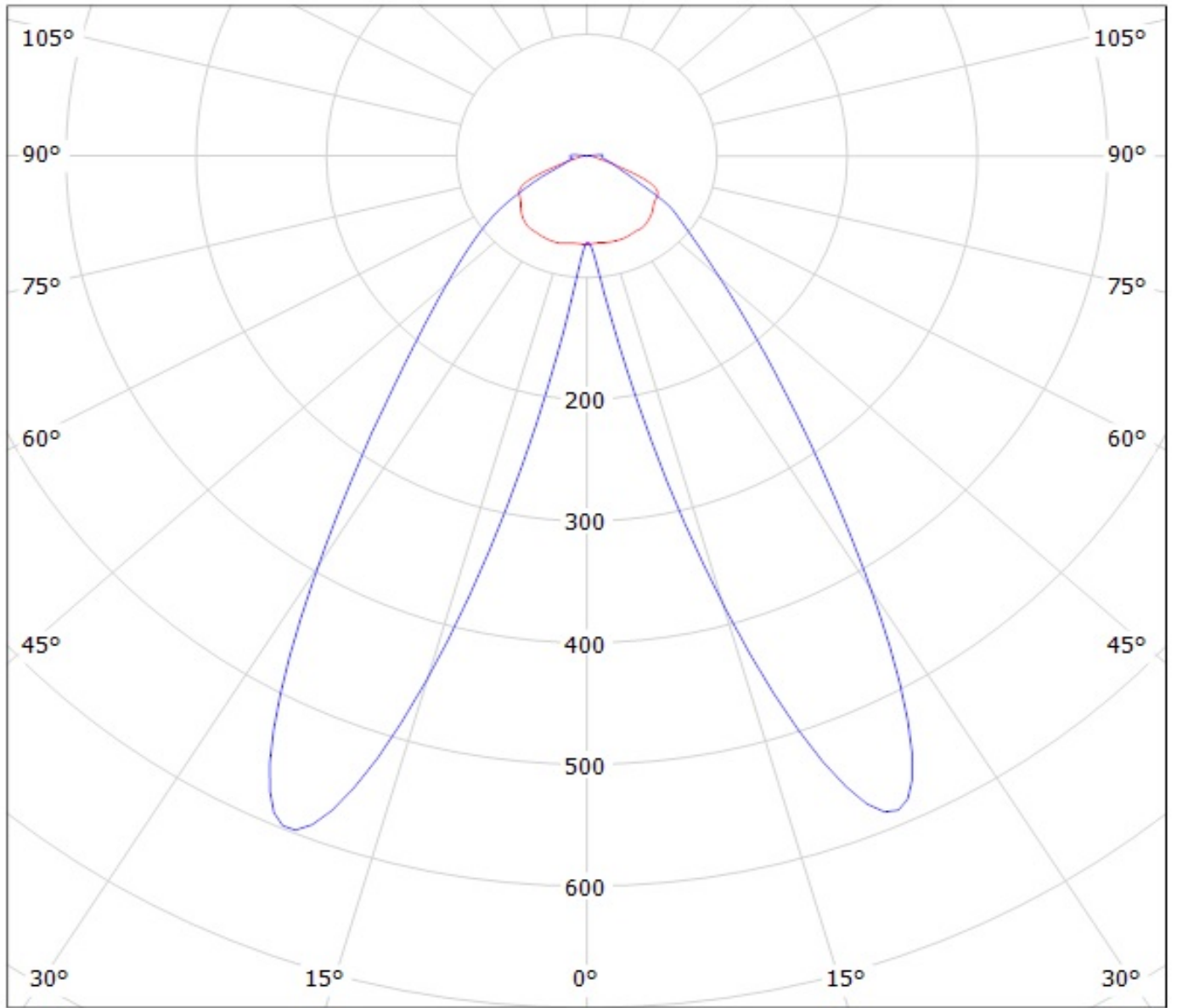

cd/klm

— C0 - C180    — C90 - C270

Luminaire: LEDiL Oy F14170\_FLORENCE-ZT25\_(Duris\_P5) Eff: 93%  
Lamps: 1 x Osram\_Duris\_P5\_756.444lm@250mA\_P=7.78777W\_I=249.8mA

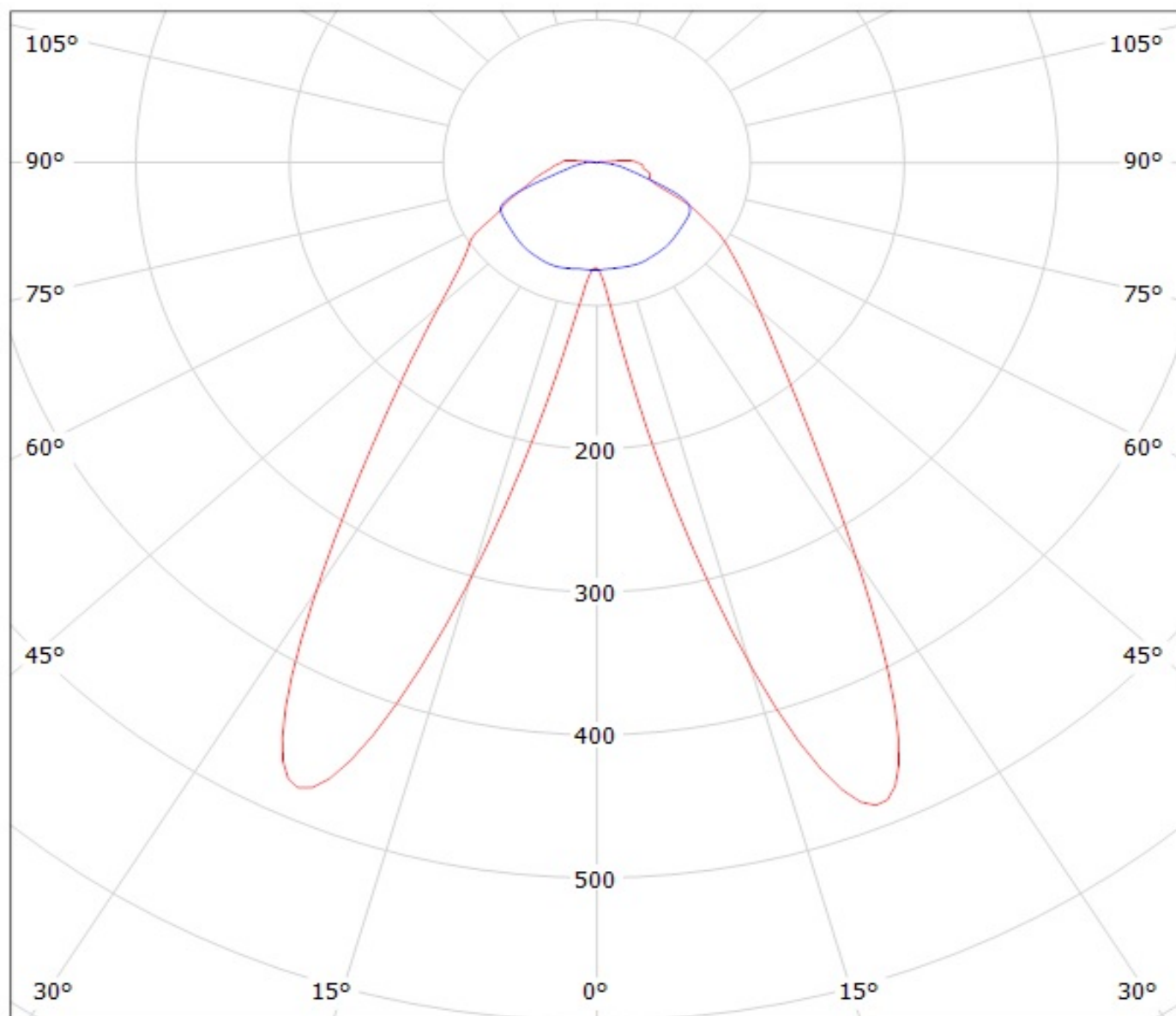

cd/klm

— C0 - C180    — C90 - C270

Luminaire: LEDiL Oy F14170\_FLORENCE-ZT25\_(Osram\_PLG2-BAR)

Lamps: 1 x Osram\_PLG2-BAR -1100-830-280x55-DC\_1021.93lm@225mA\_P=7.1643W\_I=0.225A

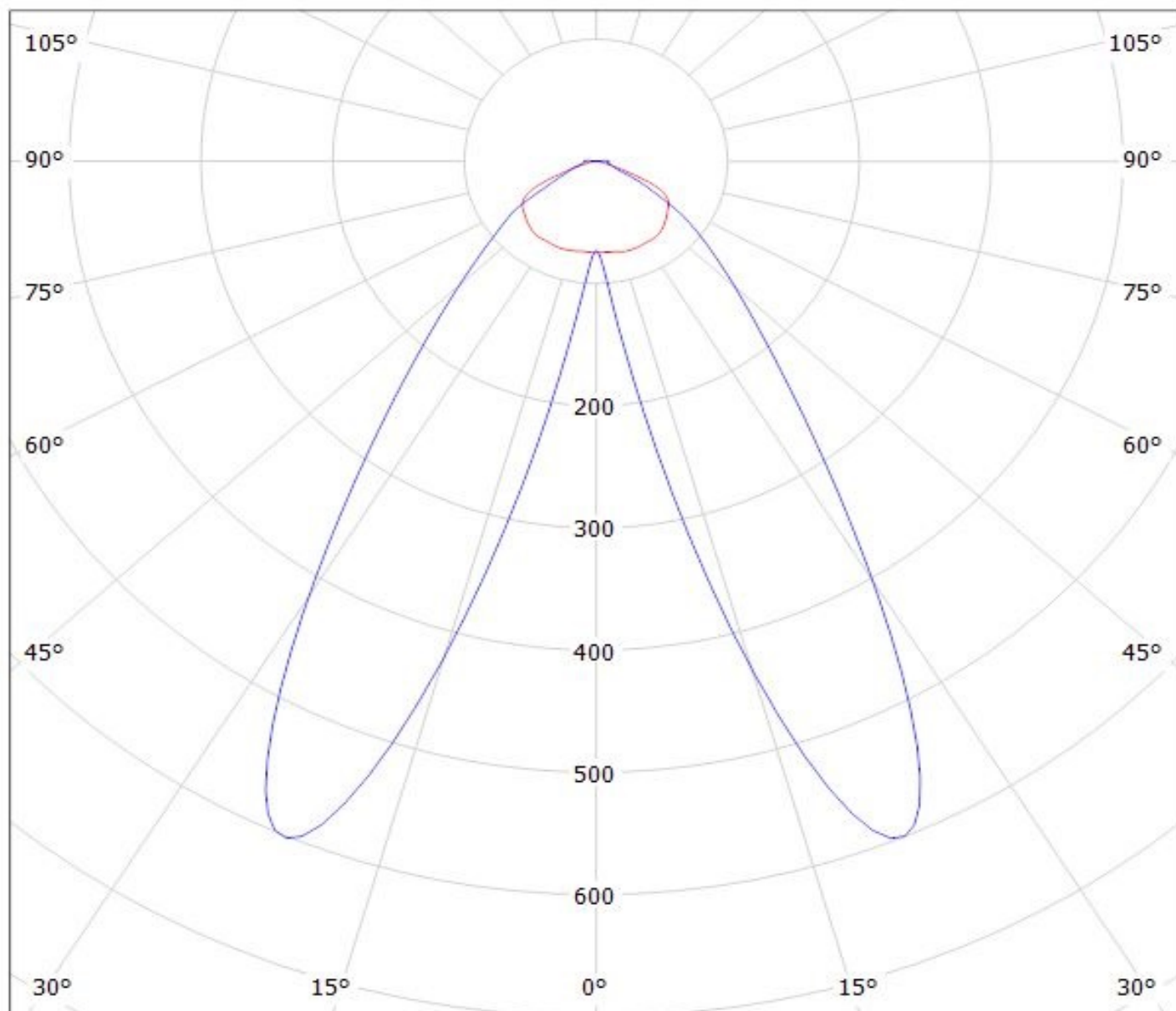

cd/klm

— C0 - C180 — C90 - C270

$\eta = 94\%$

Luminaire: Ledil F14170\_FLORENCE-ZT25\_(Duris\_S2)  
Lamps: 1 x Osram\_Duris-S2\_3x11\_(GW SBLMA1.EM-GUHQ-XX37-L1N2)  
\_876.783lm@195mA\_CCT=3000K\_P=6.3082W\_I=0.195A

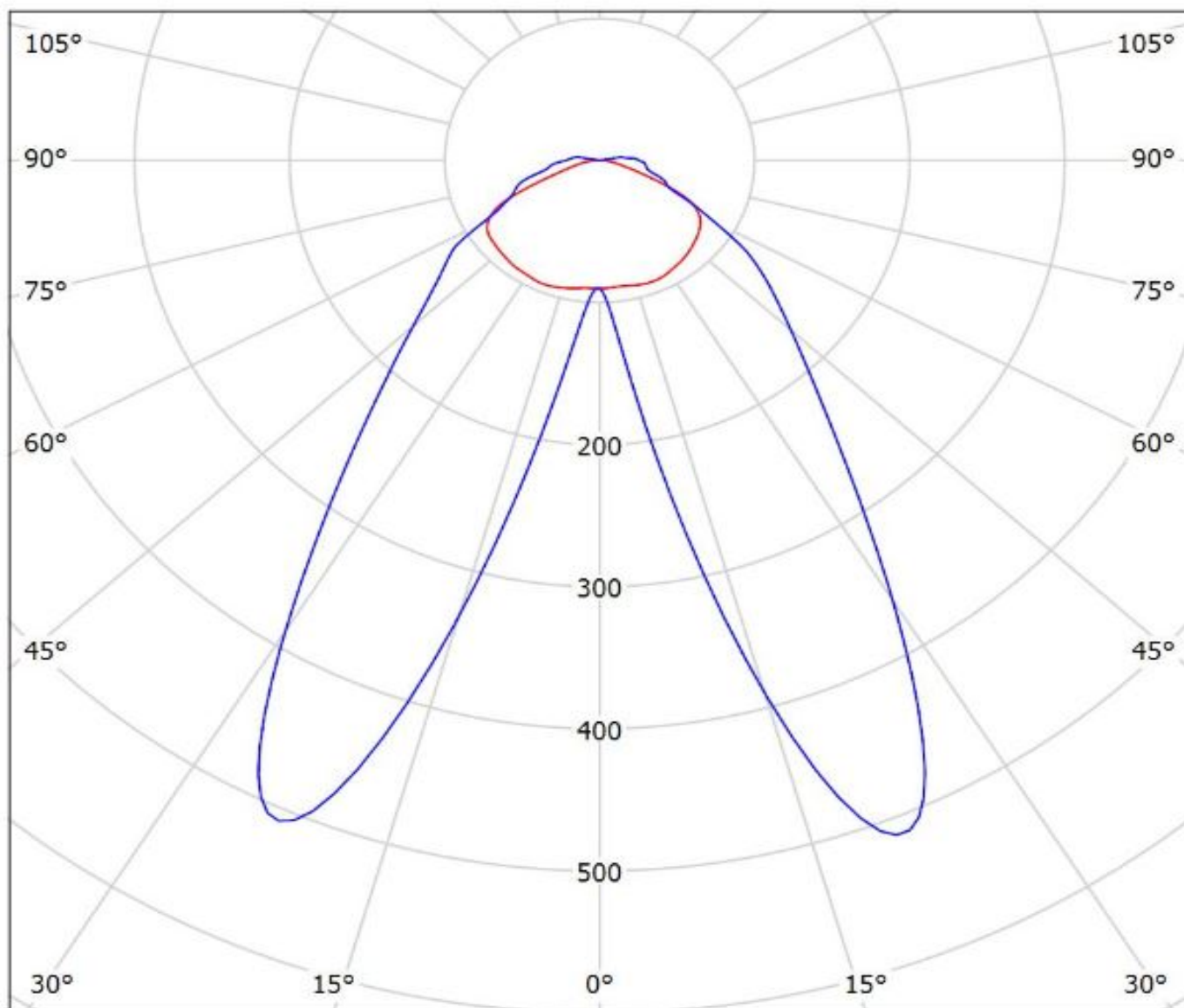

cd/klm

— C0 - C180 — C90 - C270

$\eta = 93\%$

Luminaire: Ledil Oy F14170\_FLORENCE-ZT25\_(Duris\_E\_2835)\_SIMULATED  
Lamps: 1 x Osram Duris E 2835 - GW JTLRS1.EM

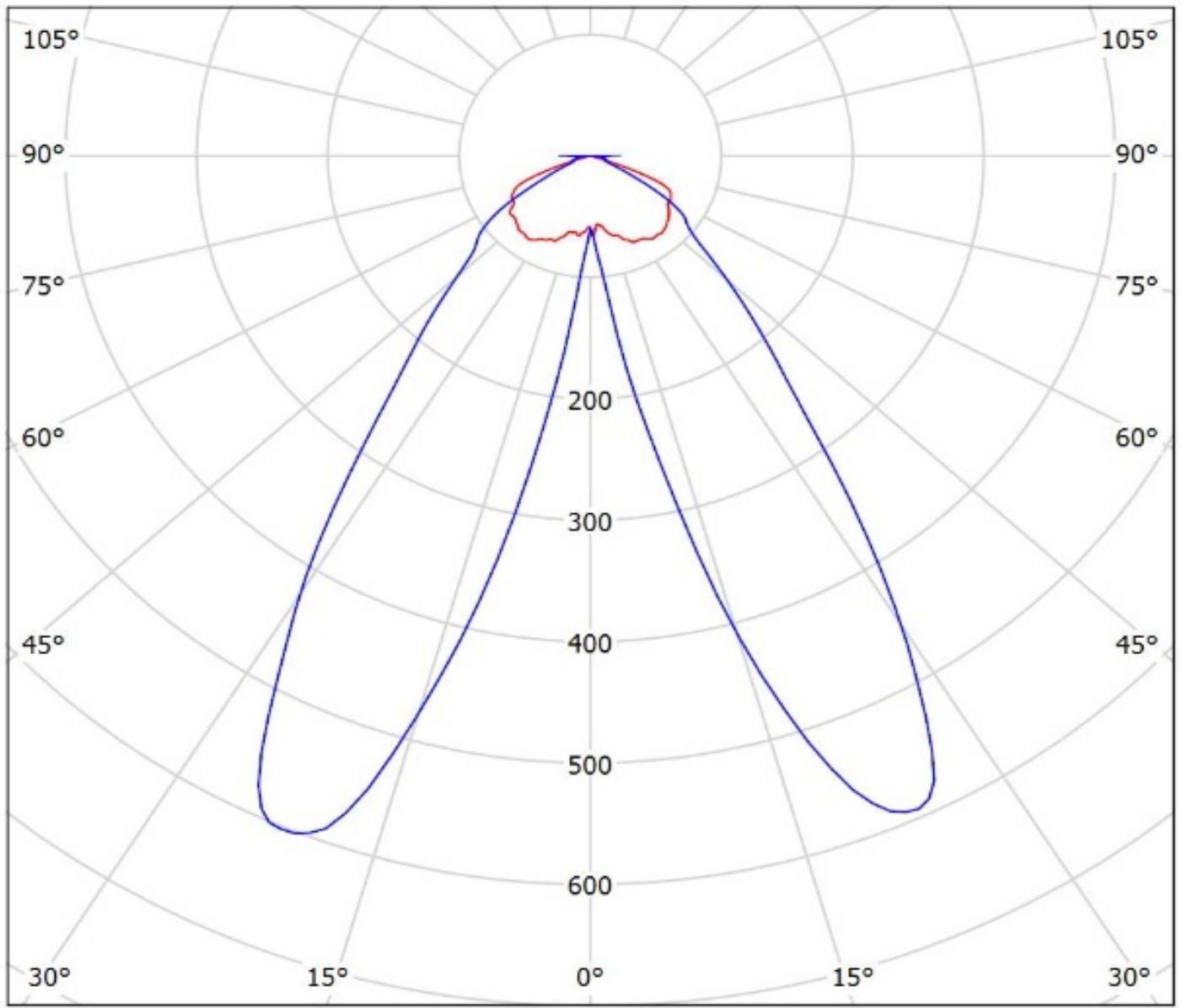

cd/klm

— C0 - C180    — C90 - C270

$\eta = 96\%$

Luminaire: LEDiL Oy F14170\_FLORENCE-ZT25\_(Oslon\_Square\_Gen3)  
Lamps: 1 x Osram\_Oslon\_Square\_Gen3\_(GW\_CSSRM2.EM)  
\_1246.56lm@250mA\_P=7.4303W\_I=0.250A

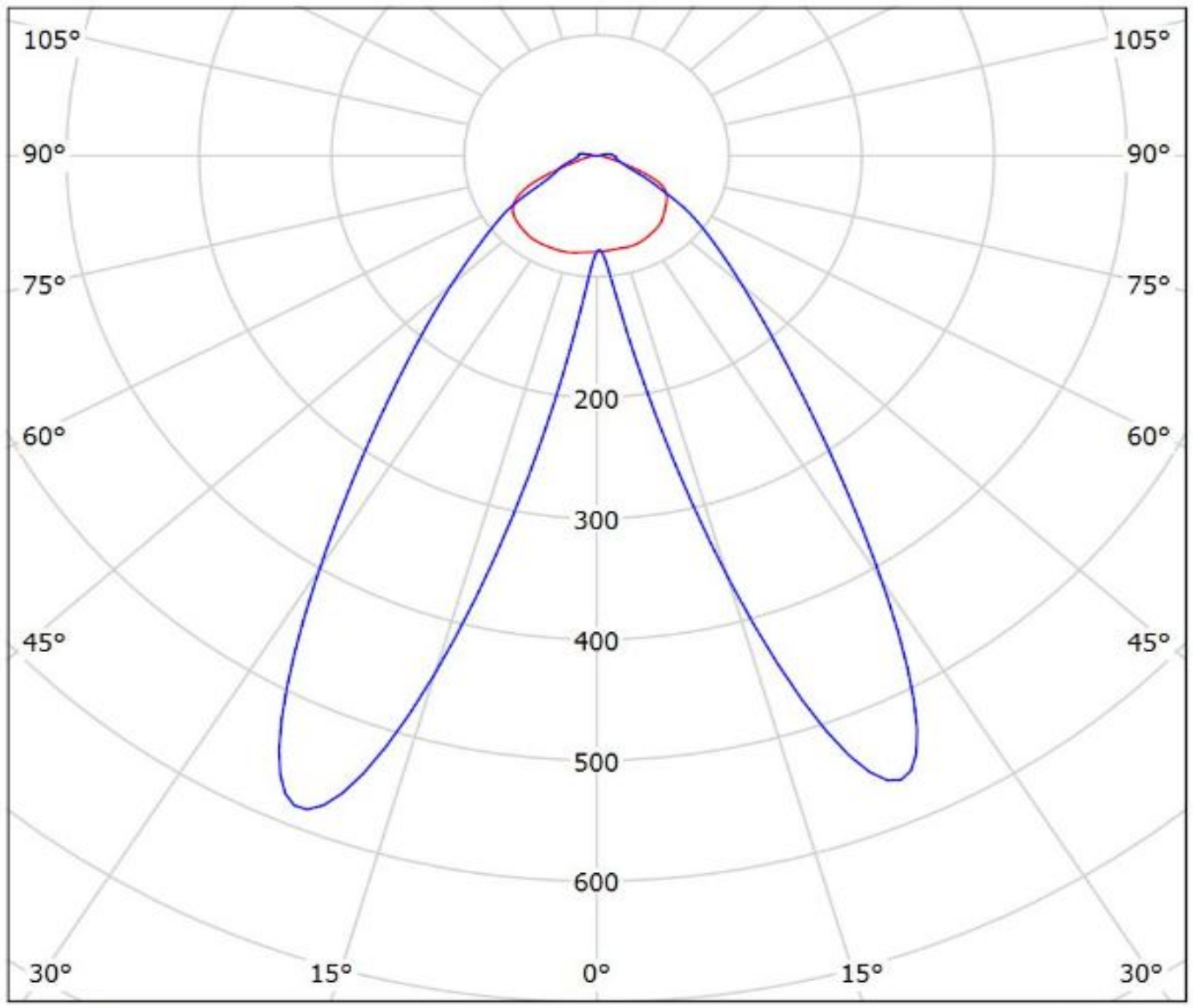

cd/klm

— C0 - C180    — C90 - C270

$\eta = 96\%$

Luminaire: Ledil Oy F14170\_FLORENCE-ZT25-Fortimo\_650lm\_3R\_SIMULATED  
Lamps: 1 x Fortimo\_650lm\_3R

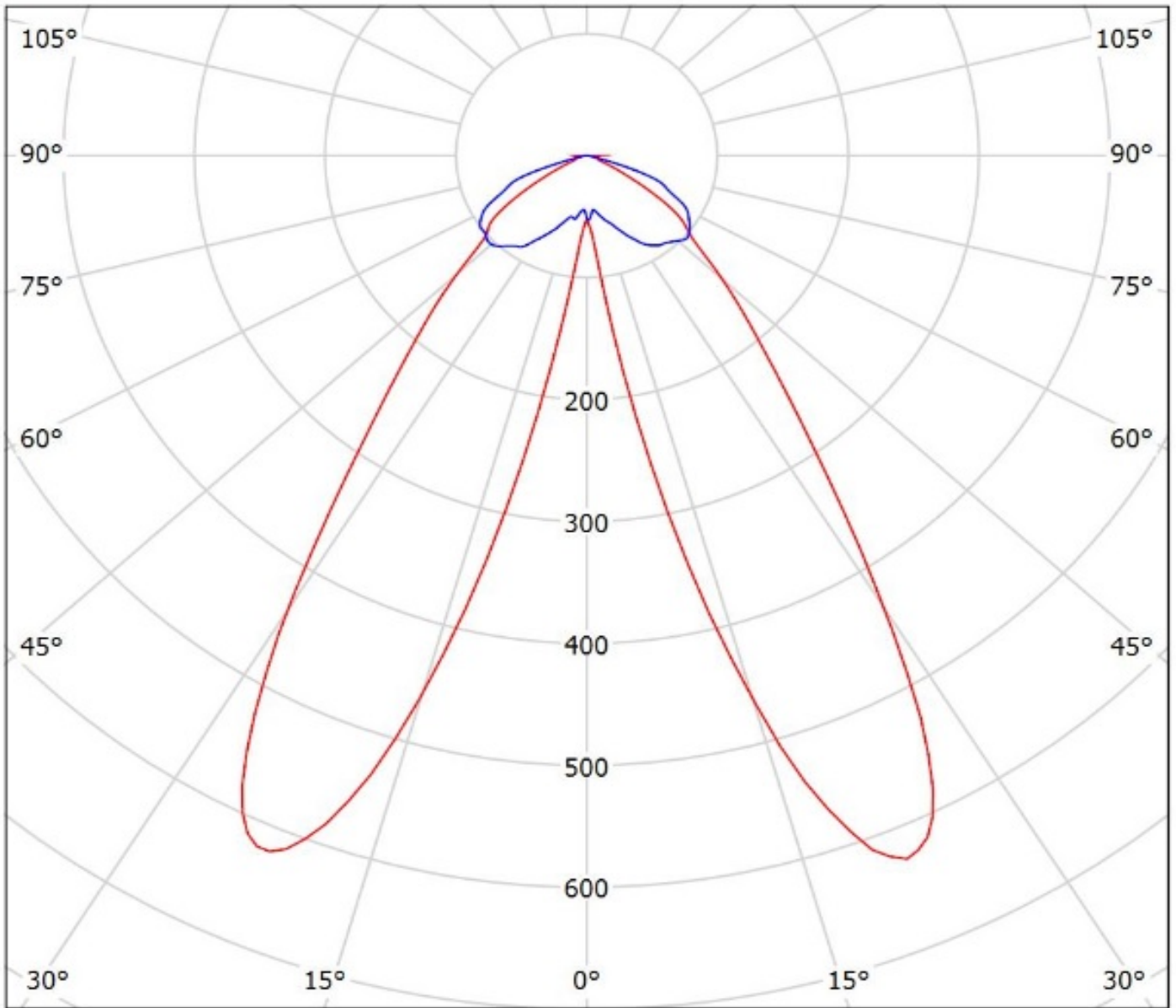

cd/klm

— C0 - C180 — C90 - C270

$\eta = 93\%$



Luminaire: Ledil F14170\_FLORENCE-ZT25\_(Fortimo\_LED\_Line\_1ft\_2000lm\_8xx\_3R\_HV2)

Lamps: 1 x Fortimo\_LED\_Line\_1ft\_2000lm\_8xx\_3R\_HV2\_1229.9lm@250mA\_CCT=3000K\_P=7.5790W\_I=0.25A

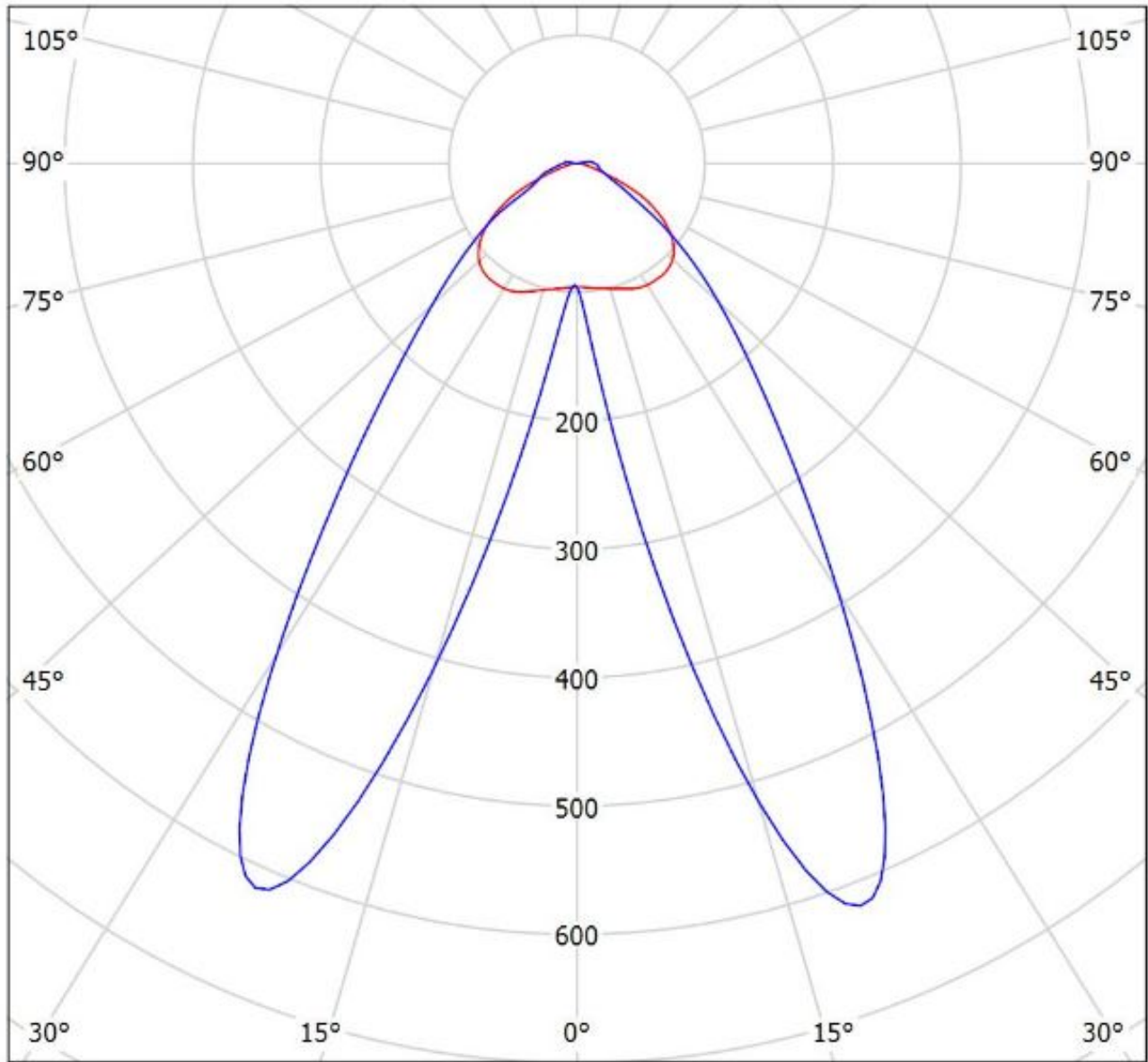

cd/klm

— C0 - C180 — C90 - C270

$\eta = 96\%$

Luminaire: LEDiL Oy F14170\_FLORENCE-ZT25\_(LM561B) Eff: 94%  
Lamps: 1 x Samsung\_LM561B\_695.232lm@150mA\_P=4.6194W\_I=0.15A

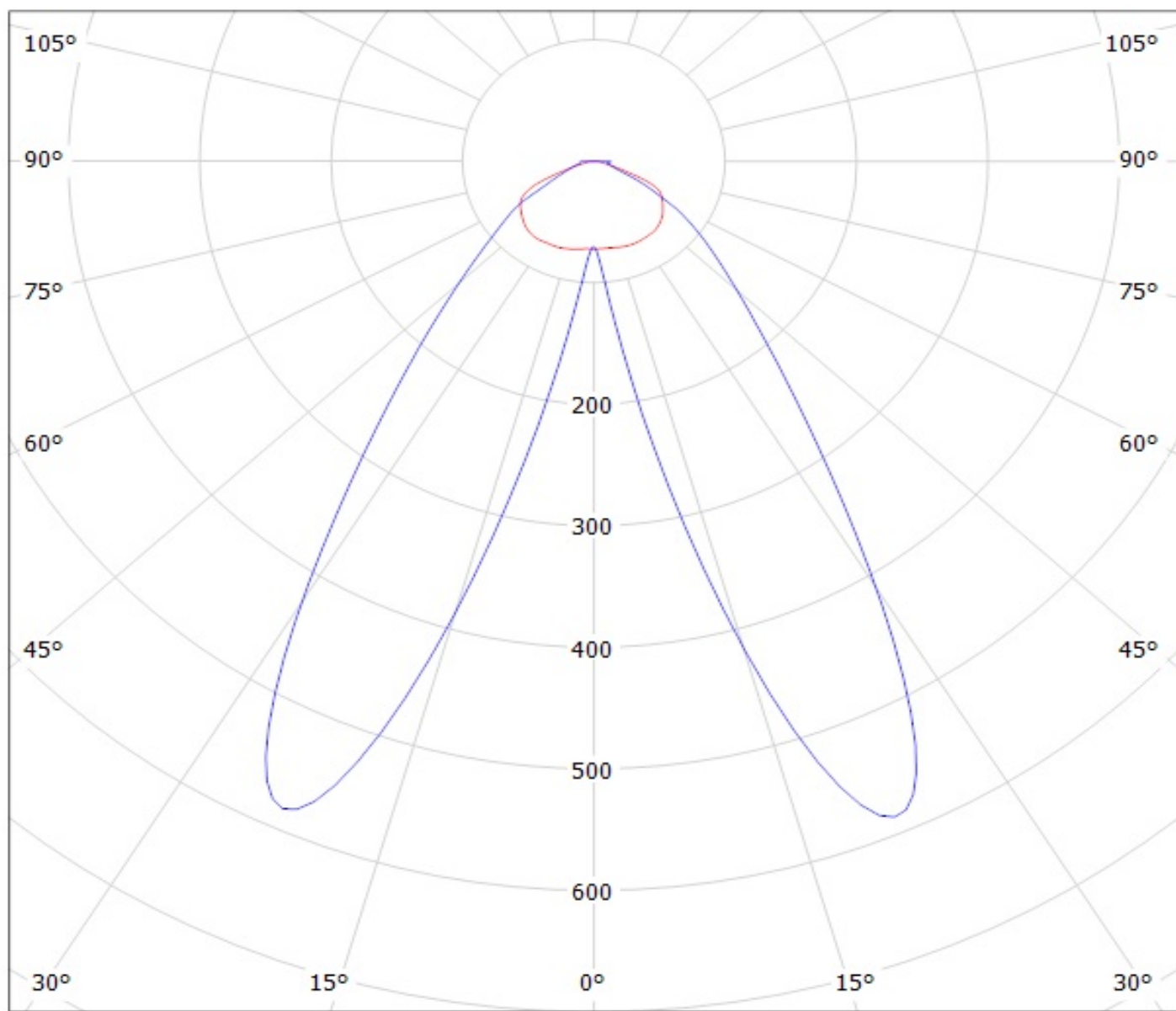

cd/klm

— C0 - C180    — C90 - C270

Luminaire: LEDiL Oy F14170\_FLORENCE-ZT25\_(LM231B) Eff: 94%  
Lamps: 1 x Samsung\_LM231B\_579lm@150mA\_P=4.62045W\_I=0.15A

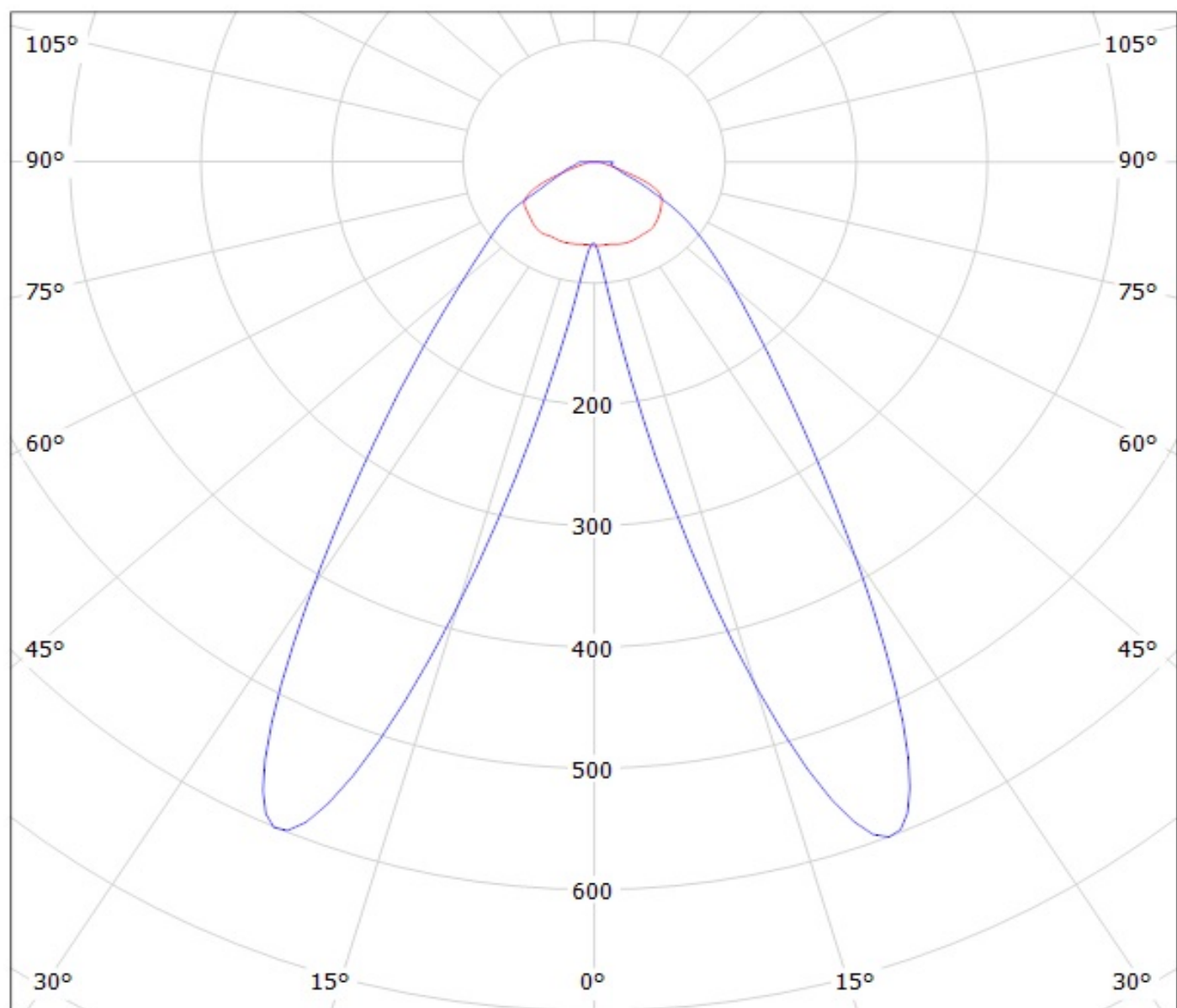

cd/klm

— C0 - C180 — C90 - C270

Luminaire: LEDiL Oy F14170\_FLORENCE-ZT25\_(LT-R286A)

Lamps: 1 x Samsung\_LT-R286A\_1304.7lm@250mA\_P=8.2181W\_I=0.250A

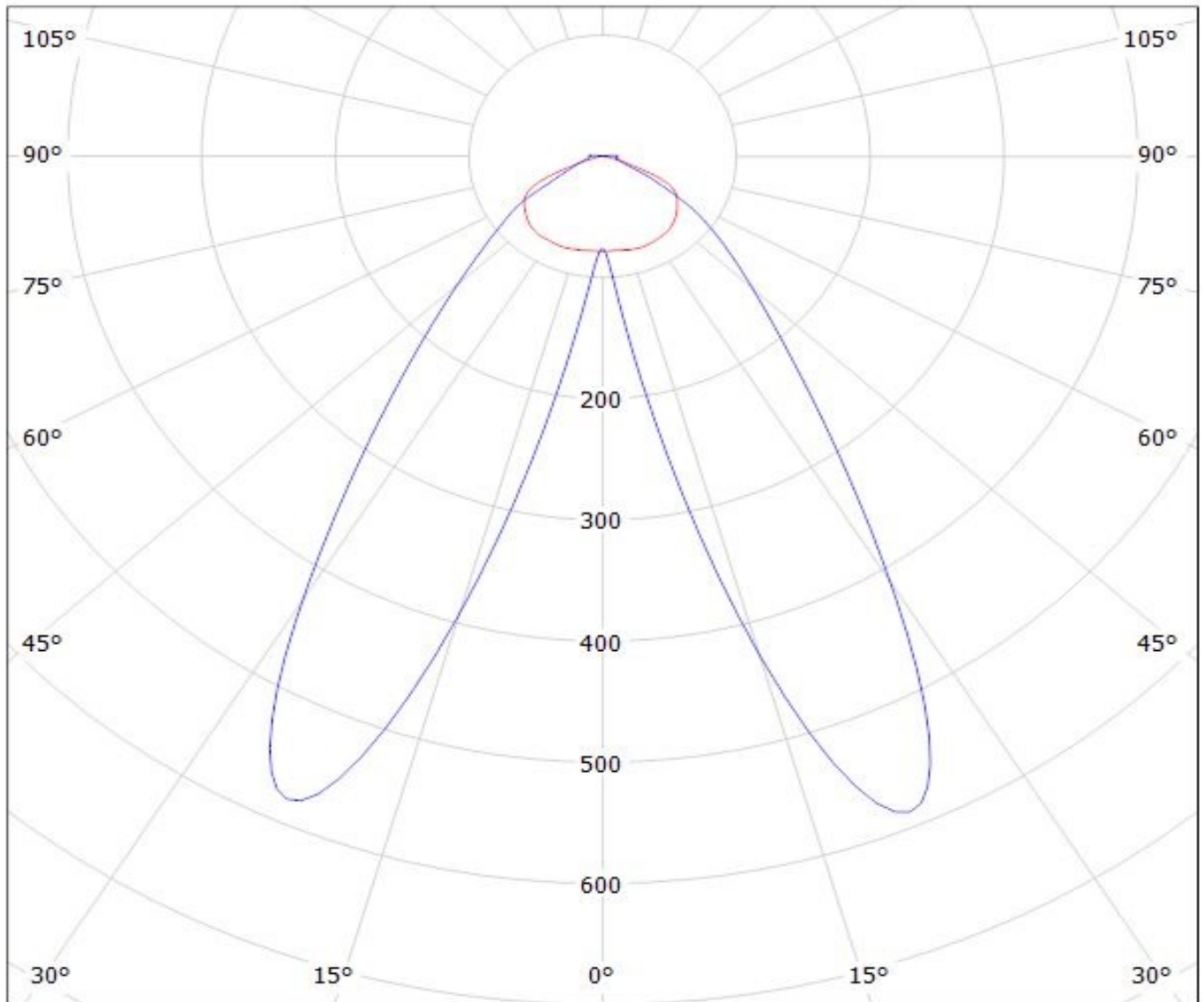

cd/klm

— C0 - C180

— C90 - C270

$\eta = 94\%$

Luminaire: Ledil Oy F14170\_FLORENCE-ZT25\_(LM281B)\_SIMULATED  
Lamps: 1 x Samsung LM281B

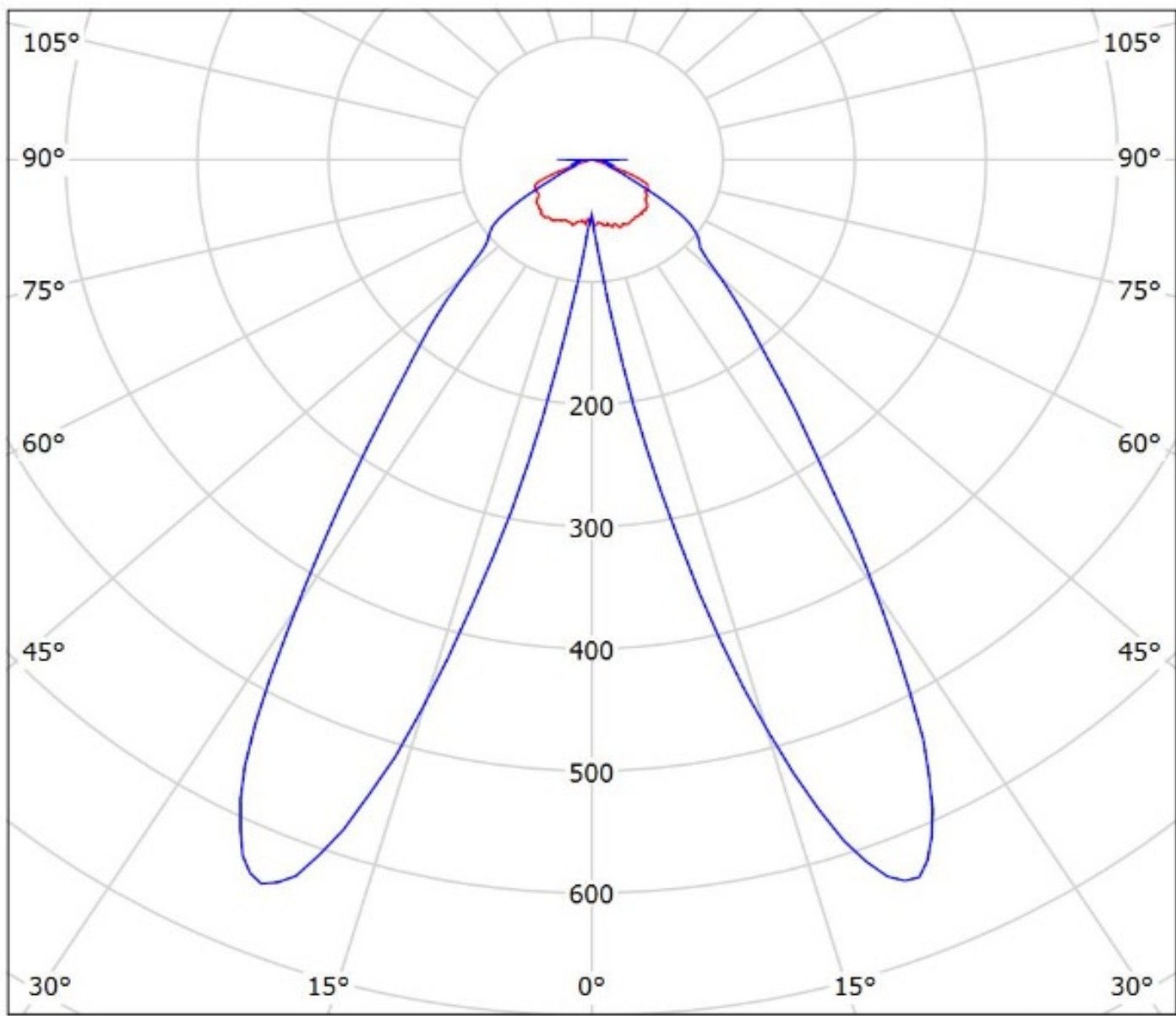

cd/klm  
— C0 - C180 — C90 - C270

$\eta = 96\%$

Luminaire: Ledil F14170\_FLORENCE-ZT25\_(LM561B+)

Lamps: 1 x Samsung\_LM561B+\_x33\_1261.92lm@250mA\_P=8.10375W\_U=32.415V

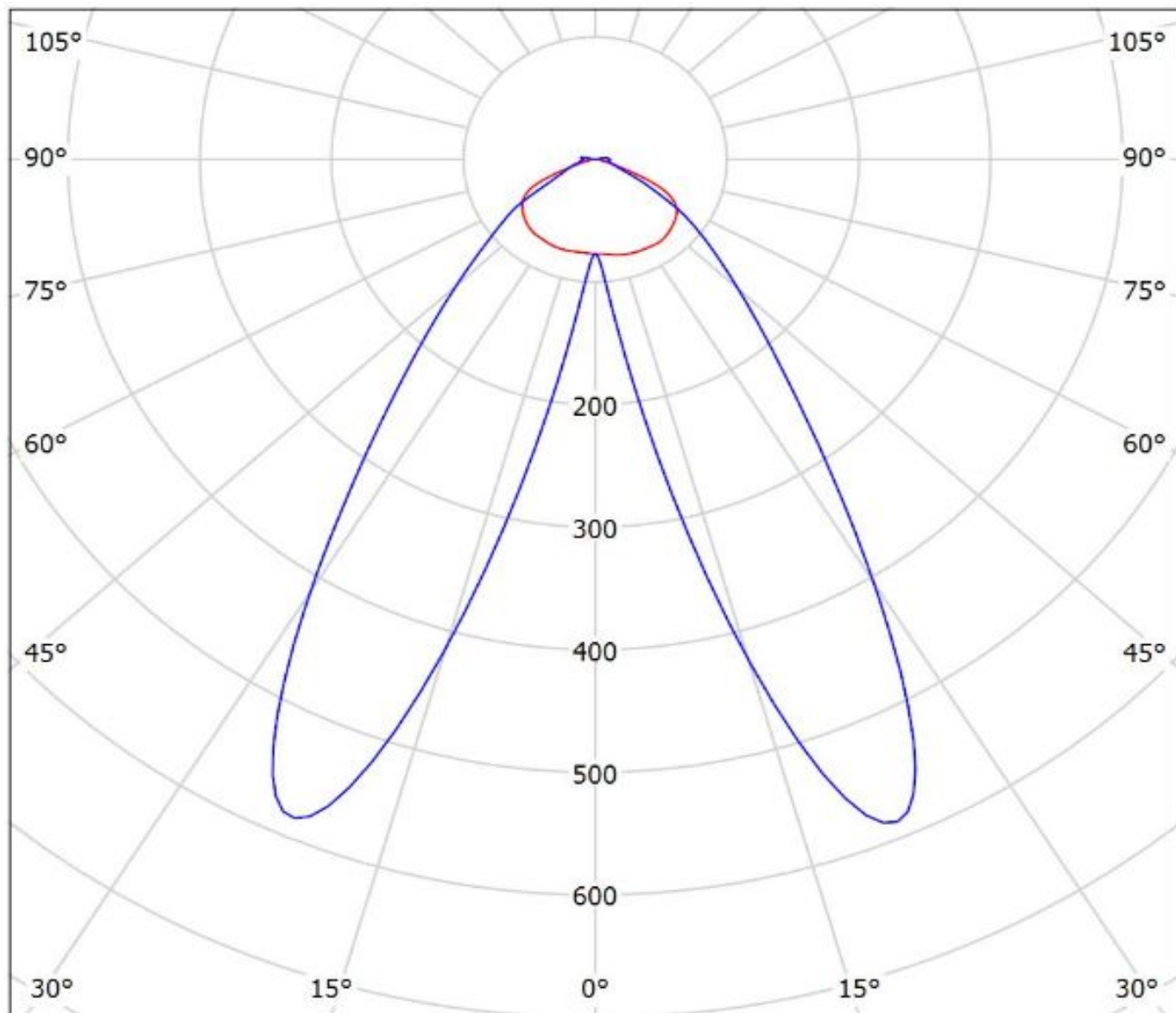

cd/klm

— C0 - C180 — C90 - C270

$\eta = 95\%$

Luminaire: Ledil Oy F14170\_FLORENCE-ZT25\_OSRAM\_DURIS\_S5\_(2chip)\_SIMULATED  
Lamps: 1 x OSRAM DURIS S5 (2chip)

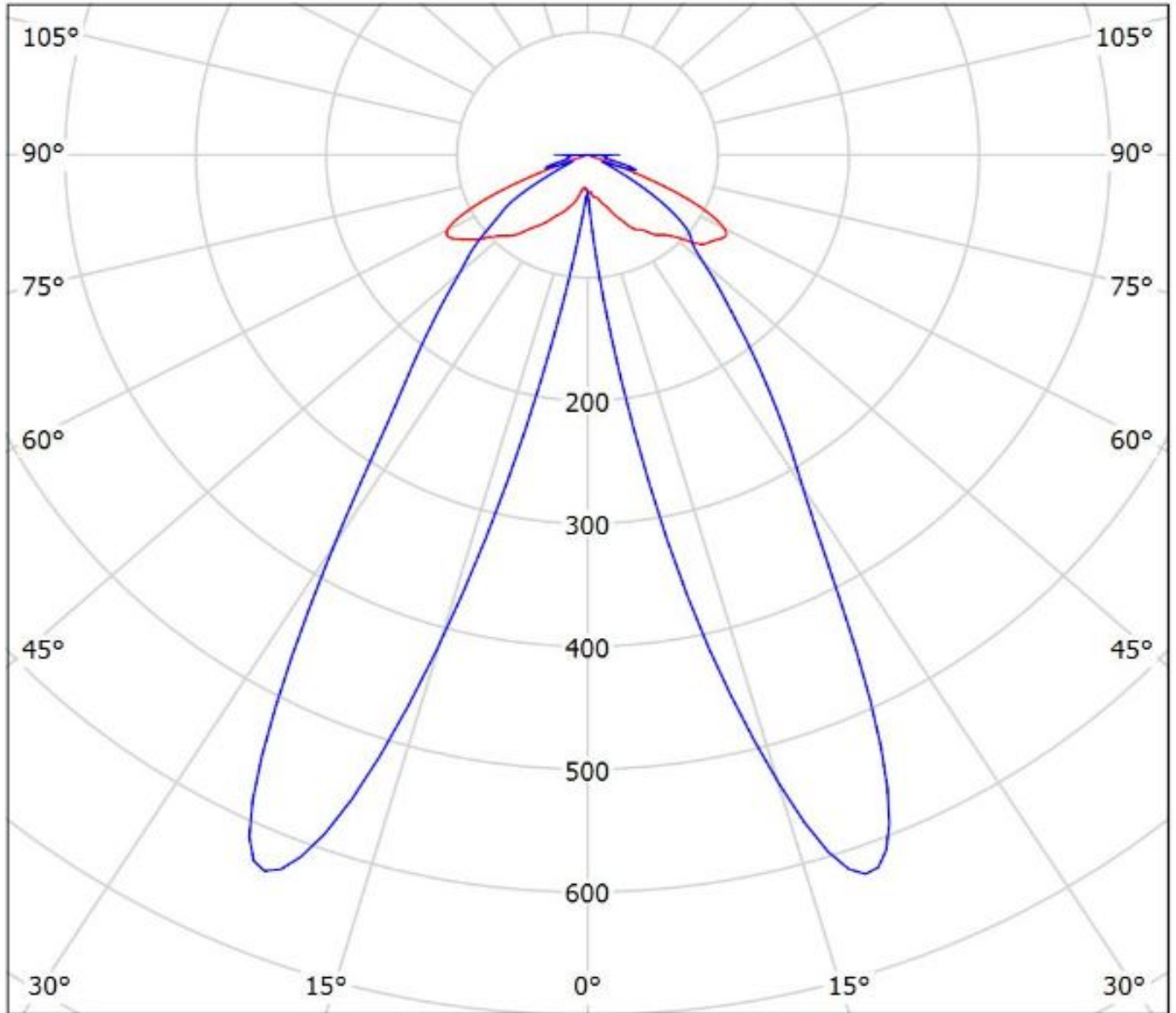

cd/klm

— C0 - C180

— C90 - C270

$\eta = 93\%$

Luminaire: Ledil Oy F14170\_FLORENCE-ZT25\_SEOUL\_5630\_D\_SIMULATED  
Lamps: 1 x SEOUL 5630 D

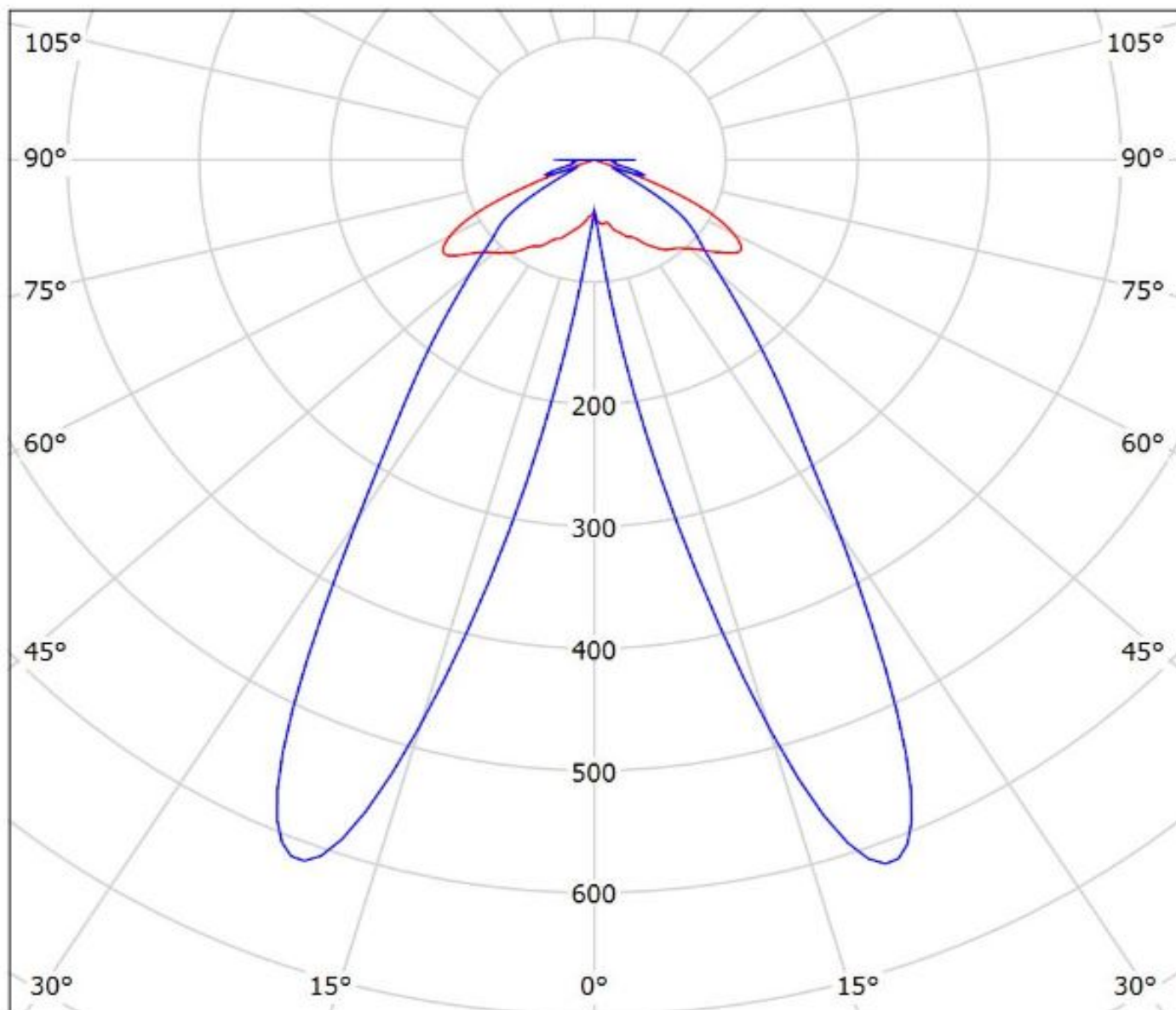

cd/klm

— C0 - C180 — C90 - C270

$\eta = 95\%$



Luminaire: LEDiL Oy F14170\_FLORENCE-ZT25\_(LLE-55-280-1650)

Lamps: 1 x Tridonic\_STARK\_LLE-55-280-1650\_(STARK\_LLE-55-280-1650-840-CLA)\_1532lm@325lm\_CCT=4000K\_P=10.1908W\_I=324.9mA

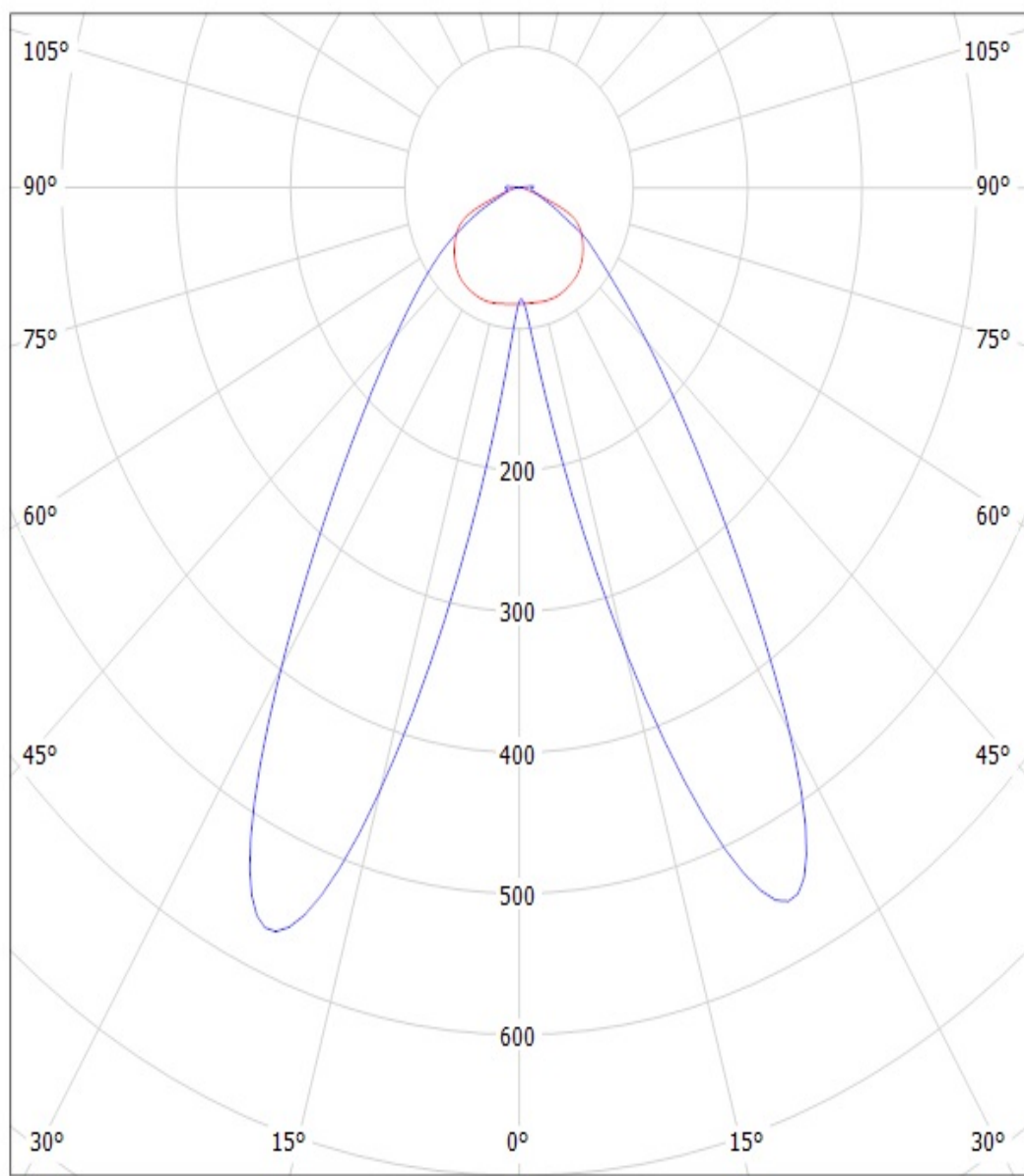

cd/klm

$\eta = 94\%$

— C0 - C180 — C90 - C270

**NOTE: The typical divergence will be changed by different color, chip size and chip position tolerance. The typical total divergence is the full angle measured where the luminous intensity is half of the peak value.**