

SMD Temperature Compensated Crystal Oscillator (PLUTO)

A series of surface mountable 7.0x5.0mm Temperature Compensated Voltage Controlled Crystal Oscillators (TCVCXOs) for medium to high volume applications where small size and high performance are prerequisites.

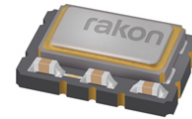

Product description

The CFPT9000 uses Rakon's proprietary ASIC 'Pluto™', a single chip oscillator and analogue compensation circuit, capable of sub 0.2ppm performance over an extended temperature range. Its ability to function down to a supply voltage of 2.4V and low power consumption makes it particularly suitable for mobile applications.

Applications

- Communications
- Other

Features

- Sub 0.2ppm stability over extended temperature range
- Wide frequency range

Specifications

1.0 SPECIFICATION REFERENCES

Line	Parameter	Description
1.1	Model description	CFPT9000
1.2	Part number format	Exxxx(LF)(T), issue A (YYYY-MM-DD)
1.3	RoHS compliant	Yes, part numbers with suffix 'LF' (non-RoHS version available upon request)
1.4	Package size	7.0mm x 5.0 x 2.25 mm. Please select footprint version P1~P4 in model code builder (for details see model drawings). P1: 10 pad (default) P2: 10 pad (inline) P3: 8 pad P4: 4 pad

2.0 FREQUENCY CHARACTERISTICS

Line	Parameter	Test Condition	Value	Unit
2.1	Nominal frequency range	Frequency range available (note 1)	1.2 to 40	MHz
2.2	Frequency calibration	Initial calibration @ 25°C	±1 max	ppm
2.3	Reflow shift	Measured ≥ 60 minutes after reflow	±1 max	ppm
2.4	Frequency stability over temperature	Reference to (Fmax + Fmin)/2	±0.2 to 2.5	ppm
2.5	Temperature range	Operating temperature range over which temperature stability is measured (wider than -40 to 85°C available on request)	-40 to 85	°C
2.6	Supply voltage stability	±10% variation, reference to frequency at nominal supply voltage, typical value	±0.2	ppm
2.7	Load sensitivity	HCMOS, AC MOS: ±5pF variation, clipped sinewave / sinewave: ±10% variation, reference to frequency at nominal load, typical value	±0.2	ppm
2.8	Long term stability	First year, ≤ 20MHz	±1 max	ppm
2.9	Long term stability	First year, > 20MHz	±2 max	ppm
2.10	Long term stability	10 years, ≤ 20MHz	±3 max	ppm
2.11	Long term stability	10 years, > 20MHz	±5 max	ppm
2.12	Acceleration sensitivity	Gamma vector, 3-axes, 30-1500Hz, typically less than...	2	ppb/g

3.0 POWER SUPPLY

Line	Parameter	Test Condition	Value	Unit
3.1	Supply voltage	Nominal supply voltage ($\pm 10\%$) to be specified as part of model code	2.4 to 6	V
3.2	Current Clipped Sinewave	typically: $1 + \text{frequency(MHz)} * 1.2 * \{\text{load(pF)} + 30\} * 10^{-3} \text{mA}$		mA
3.3	Current Sinewave		8 max	mA
3.4	Current HCMOS	typically: $1 + \text{frequency(MHz)} * \text{supply(V)} * \{\text{load(pF)} + 15\} * 10^{-3} \text{mA}$ e.g 20MHz, 5V, 15pF = 4mA		mA

4.0 CONTROL VOLTAGE

Line	Parameter	Test Condition	Value	Unit
4.1	Control voltage range	Without reference voltage; $V_s = 5.0\text{V}$	1.5 to 3.5	V
4.2	Control voltage range	Without reference voltage; $V_s = 3.3\text{V}$	0.65 to 2.65	V
4.3	Control voltage range	With reference voltage (when specified as part of the model code): 0 to V_{ref} [V]		V
4.4	Frequency tuning (standard)	$\leq 20\text{MHz}$ (note 3)	± 5 min	ppm
4.5	Frequency tuning (standard)	$> 20\text{MHz}$ (note 3)	± 7 min	ppm
4.6	Slope	Positive		
4.7	Linearity		1 max	%
4.8	Port input impedance	Measured between control voltage and GND pin	100 min	k Ω
4.9	Modulation bandwidth		2 min	kHz

5.0 OSCILLATOR OUTPUT - CLIPPED SINEWAVE

Line	Parameter	Test Condition	Value	Unit
5.1	Output waveform	AC coupled clipped sinewave		
5.2	Output voltage level	Peak to peak voltage	0.8 min	V
5.3	Output load resistance		10	k Ω
5.4	Output load capacitance		10	pF

6.0 OSCILLATOR OUTPUT - SINEWAVE

Line	Parameter	Test Condition	Value	Unit
6.1	Output waveform	AC coupled sinewave		
6.2	Output voltage level	Peak to peak voltage $\leq 20\text{MHz}$	1 min	V
6.3	Output voltage level	Peak to peak voltage $> 20\text{MHz}$	0.5 min	V
6.4	Output load resistance		10	k Ω
6.5	Output load capacitance		10	pF

7.0 OSCILLATOR OUTPUT - HCMOS

Line	Parameter	Test Condition	Value	Unit
7.1	Output waveform	HCMOS (note ACMOS available upon request)		
7.2	Output voltage level low (VoL)		0.1 max	Vs
7.3	Output voltage level high (VoH)		0.9 min	Vs
7.4	Rise and fall times	Measured with $V_{\text{cc}} = 3.3\text{V}$	8 max	ns
7.5	Rise and fall times	Measured with $V_{\text{cc}} = 5.0\text{V}$	7 max	ns
7.6	Duty cycle	Measured at 50% level	45 to 55	%
7.7	Load	Nominal	15	pF

8.0 TRISTATE CONTROL

Line	Parameter	Test Condition	Value	Unit
8.1	Output enabled	Tristate control pin logic '1' (high) or open circuit	60 min	%Vs
8.2	Output in tristate mode	Tristate control pin logic '0' (low)	20 max	%Vs
8.3	Note	See note 2		

9.0 PHASE NOISE

Line	Parameter	Test Condition	Value	Unit
9.1	SSB phase noise power density at 1Hz offset	Typical value for a 13MHz oscillator at 25°C	-65	dBc/Hz
9.2	SSB phase noise power density at 10Hz offset	Typical value for a 13MHz oscillator at 25°C	-95	dBc/Hz
9.3	SSB phase noise power density at 100Hz offset	Typical value for a 13MHz oscillator at 25°C	-120	dBc/Hz
9.4	SSB phase noise power density at 1kHz offset	Typical value for a 13MHz oscillator at 25°C	-135	dBc/Hz
9.5	SSB phase noise power density at 10kHz offset	Typical value for a 13MHz oscillator at 25°C	-140	dBc/Hz
9.6	SSB phase noise power density at 100kHz offset	Typical value for a 13MHz oscillator at 25°C	-145	dBc/Hz

10.0 OTHER FEATURES

Line	Parameter	Description
10.1	Reference voltage, Vref	Optional reference voltage output (suitable for potentiometer supply or DAC reference) - see model code builder. Note this option is available for package P1 only.

11.0 ENVIRONMENTAL INFORMATION

Line	Parameter	Description
11.1	Shock	IEC 60068-2-27, test Ea. 1500gn acceleration for 0.5ms duration, half sine pulse, 3 shocks in each direction along three mutually perpendicular axes
11.2	Vibration	IEC 60068-2-6, test Fc. 10-60Hz 1.5mm displacement, 60-2000Hz at 10gn, 30 minutes in each of three mutually perpendicular axes at 1 octave per minute
11.3	Storage temperature	-55°C to 125°C

12.0 PIN CONNECTIONS (outline P1)

Line	Parameter	Description
12.1	Pin 1	Vref* (optional, see section 10 above)
12.2	Pin 2	N/C
12.3	Pin 3	Do not connect
12.4	Pin 4	GND
12.5	Pin 5	Output
12.6	Pin 6	N/C
12.7	Pin 7	N/C
12.8	Pin 8	Tristate Control (Enable)* (note 2)
12.9	Pin 9	Supply Voltage, +Vs
12.10	Pin 10	Control Voltage, Vc (Frequency Adjust), or Do not connect (dependent on option selected as part of the model code)
12.11	Note	*Leave unconnected if not required.

13.0 PIN CONNECTIONS (outline P2)

Line	Parameter	Description
13.1	Pin 1	Control Voltage, Vc (Frequency Adjust), or Do not connect (dependent on option selected as part of the model code)
13.2	Pin 2	GND
13.3	Pin 3	Output
13.4	Pin 4	Supply Voltage, +Vs
13.5	Note	The additional pads are internally connected, these can be soldered to floating pads but do not connect to them.

14.0 PIN CONNECTIONS (outline P3)

Line	Parameter	Description
14.1	Pin 1	Control Voltage, Vc (Frequency Adjust), or Do not connect (dependent on option selected as part of the model code)
14.2	Pin 2	GND
14.3	Pin 3	Output
14.4	Pin 4	Supply Voltage, +Vs
14.5	Pin T1	Do not connect
14.6	Pin T2	Do not connect
14.7	Pin T3	N/C
14.8	Pin T4	Tri-state Control (Enable)* (note 2)
14.9	Note	*Leave unconnected if not required.

15.0 PIN CONNECTIONS (outline P4)

Line	Parameter	Description
15.1	Pin 1	Control Voltage, Vc (Frequency Adjust), or Do not connect (dependent on option selected as part of the model code)
15.2	Pin 2	GND
15.3	Pin 3	Output
15.4	Pin 4	Supply Voltage, +Vs

16.0 MARKING

Line	Parameter	Description
16.1	Type	Laser marked.
16.2	Line 1	[R X XX] Rakon, manufacturing identifier (X XX).
16.3	Line 2	[Δ 0000 YW] Pad 1 / static sensitivity identifier (Δ), abbreviated part number (0000), device date code (YW).

17.0 MANUFACTURING INFORMATION

Line	Parameter	Description
17.1	Reflow Soldering	See reflow profile diagram. Solderability: MIL-STD-202, method 208, category 3.
17.2	Packaging description	Quantities \geq 100 pieces will be supplied on tape & reel.

18.0 NOTES

Line	Parameter	Description
18.1	Note 1	Frequency range available dependent on output type. HCMOS (& AC MOS): 1.25-40MHz, sinewave: 10-40MHz, clipped sinewave: 10-40MHz.
18.2	Note 2	The tristate control (enable) pin has a internal 100k Ω pull up resistor which allows the pin to be left unconnected if not required. When in tristate mode, the output stage is disabled, but the oscillator and compensation circuit are still active (current consumption typ. \leq 1.0mA). Availability of tristate and the tristate control pin number will depend on the outline selected (P1~P4). Alternative pin configurations may be available upon request - please contact the sales office: sales@rakon.com.
18.3	Note 3	Higher pulling may be available as a custom option depending on nominal frequency and stability - please contact the sales office: sales@rakon.com.

Drawing Name: CFPT9000 Model Drawing - P1

MODEL DRAWING

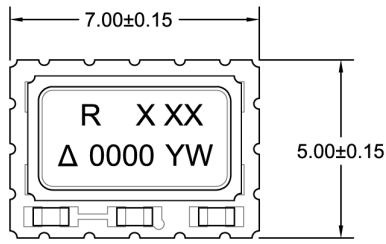

TOP VIEW

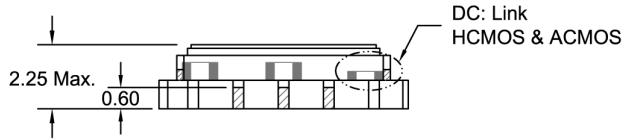

FRONT VIEW (DC)

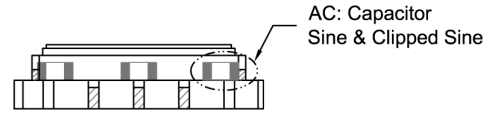

FRONT VIEW (AC)

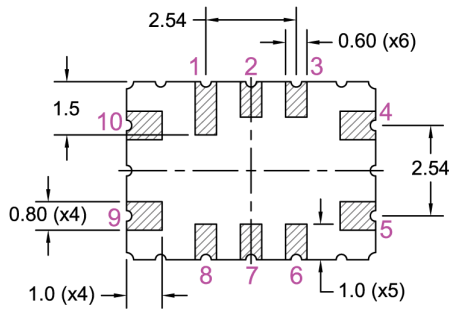

BOTTOM VIEW

NOTE:
Pin connections are detailed in the specification.

RECOMMENDED PAD LAYOUT - TOP VIEW

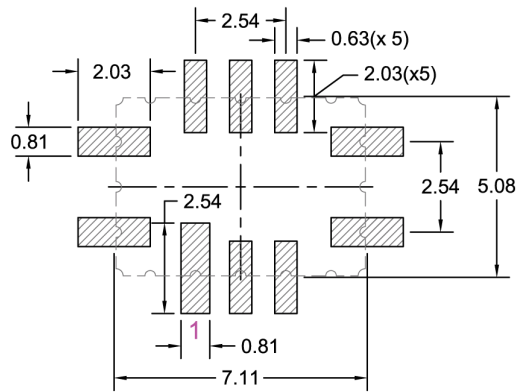

TITLE: CFPT9000 Model 10P Standard (P1)

RELATED DRAWINGS:

FILENAME: CAT704

REVISION: A

DATE: 03-Aug-12

SCALE: 5 : 1

Millimetres

TOLERANCES:

XX = ±0.5

X.X = ±0.2

X.XX = ±0.10

X.XXX = ±0.05

X° = ±1.0°

Hole = ±0.10

rakon

© 2009 Rakon Limited

Drawing Name: CFPT9000 Model Drawing - P2

MODEL DRAWING

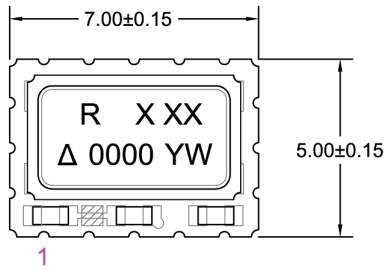

1
TOP VIEW

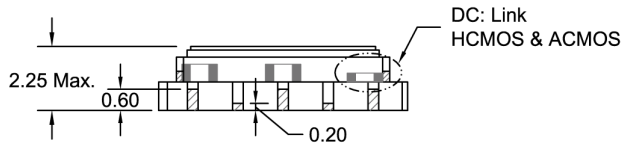

FRONT VIEW (DC)

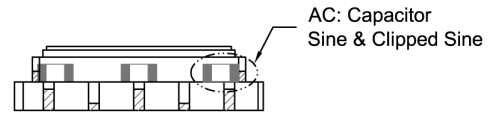

FRONT VIEW (AC)

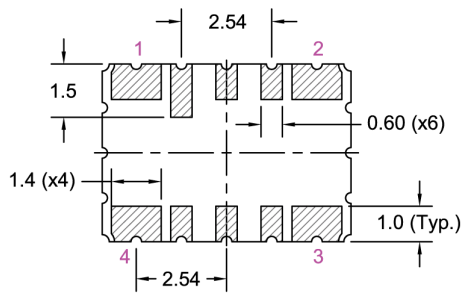

BOTTOM VIEW

NOTE:
Pin connections are detailed in the specification.

RECOMMENDED PAD LAYOUT - TOP VIEW

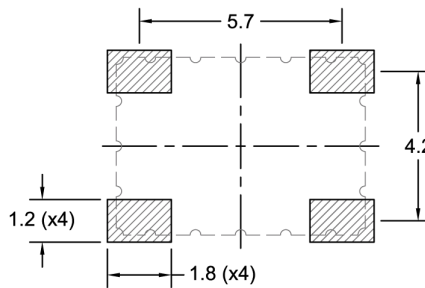

TITLE: CFPT9000 Model 10P Inline (P2)

RELATED DRAWINGS:

FILENAME: CAT705

REVISION: A

DATE: 03-Aug-12

SCALE: 5 : 1

Millimetres

TOLERANCES:

XX = ±0.5

X.X = ±0.2

X.XX = ±0.10

X.XXX = ±0.05

X° = ±1.0°

Hole = ±0.10

rakon

© 2009 Rakon Limited

Drawing Name: CFPT9000 Model Drawing - P3

MODEL DRAWING

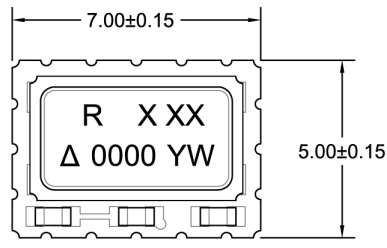

TOP VIEW

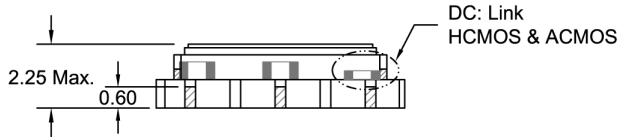

FRONT VIEW (DC)

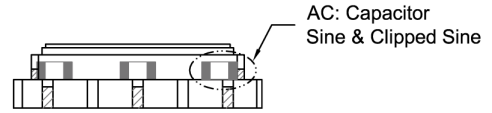

FRONT VIEW (AC)

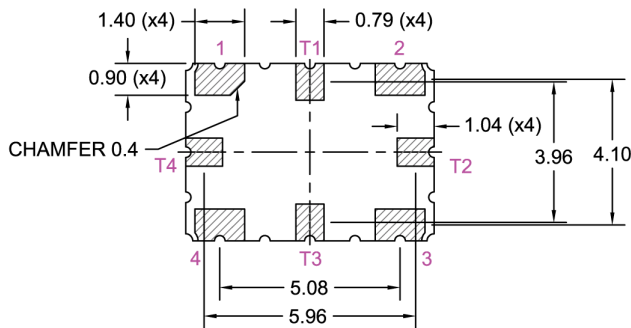

BOTTOM VIEW

NOTE:
Pin connections are detailed in the specification.

RECOMMENDED PAD LAYOUT - TOP VIEW

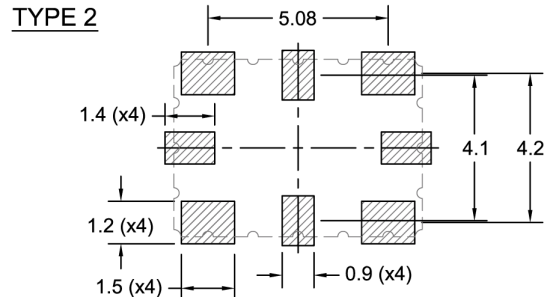
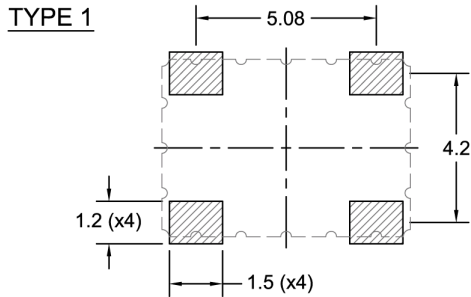

TITLE: CFPT9000 Model 8P (P3)

RELATED DRAWINGS:

FILENAME: CAT706

REVISION: A

DATE: 03-Aug-12

SCALE: 5 : 1

Millimetres

TOLERANCES:

XX = ±0.5

X.X = ±0.2

X.XX = ±0.10

X.XXX = ±0.05

X° = ±1.0°

Hole = ±0.10

rakon

© 2009 Rakon Limited

Drawing Name: CFPT9000 Model Drawing - P4

MODEL DRAWING

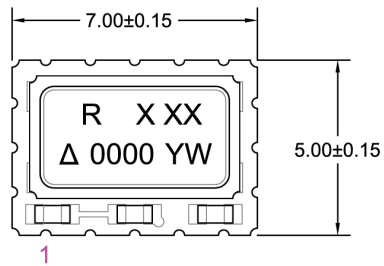

TOP VIEW

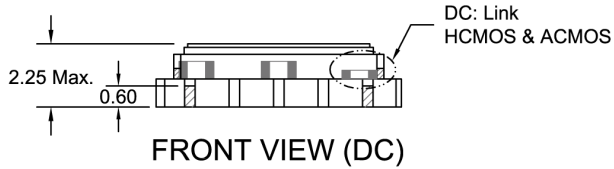

FRONT VIEW (DC)

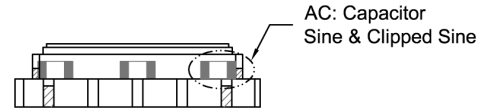

FRONT VIEW (AC)

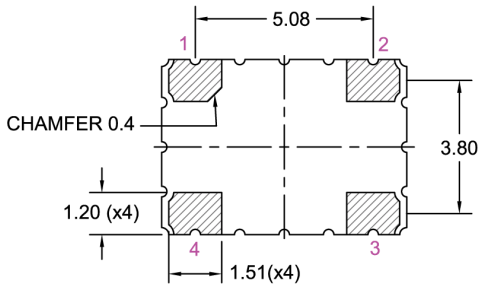

BOTTOM VIEW

NOTE:
Pin connections are detailed in the specification.

RECOMMENDED PAD LAYOUT - TOP VIEW

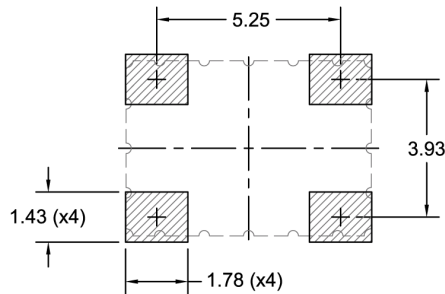

TITLE: CFPT9000 Model 4P (P4)

RELATED DRAWINGS:

FILENAME: CAT707

REVISION: A

DATE: 03-Aug-12

SCALE: 5 : 1

Millimetres

TOLERANCES:

XX = ±0.5

X.X = ±0.2

X.XX = ±0.10

X.XXX = ±0.05

X° = ±1.0°

Hole = ±0.10

rakon

© 2009 Rakon Limited

MODEL CODE BUILDER:

CFPT900XXXXXXX10M0

PRODUCT CODE

CFPT = Pluto USTCXO

PACKAGE CODE

900 = 7 x 5 mm

ELECTRICAL SPECIFICATION CODE

- 1 = 5.0V HCMOS
- 3 = 5.0V Sine Wave
- 5 = 5.0V Clipped Sine Wave
- 6 = 3.3V HCMOS
- 7 = 3.3V Sine Wave
- 8 = 3.3V Clipped Sine Wave

TEMPERATURE STABILITY CODE

±0.3	±0.5	±1.0	±1.5	±2.0	±2.5	(ppm)
AP	EP	FP	CP	GP	HP	0 to 50°C
AC*	EC	FC	CC	GC	HC	0 to 70°C
AS*	ES	FS	CS	GS	HS	-20 to 70°C
AU*	EU*	FU	CU	GU	HU	-30 to 75°C
AX*	EX*	FX	CX	GX	HX	-40 to 85°C

* Code may not be available for all frequency

Frequency in MHz

10M0 = 10 MHz

RoHS CODE

LF = RoHS compliant

FOOTPRINT CODE

- P1 = 10 pad default P3 = 8 pad
- P2 = 10 pad inline P4 = 4 pad

FREQUENCY ADJUSTMENT CODE

- A = Aging adjustment (standard option)
 - ≥ ±5ppm, frequency ≤ 20MHz
 - ≥ ±7ppm, frequency > 20MHz
- B = No frequency adjustment initial calibration @ 25°C ≤ ±1.0ppm
- C = High pulling ±10ppm to ±20ppm can be available depending on frequency and stability options. Please consult our sales office

REFERENCE VOLTAGE CODE

- 1 = No output (standard option)
- 2 = 2.2V for Min. Vs > 2.4V
- 3 = 2.7V for Min. Vs > 3.0V
- 4 = 4.2V for Min. Vs > 4.0V

Note: maximum load current (mA) = Vref/10

TITLE: CFPT900 Model Code Builder

RELATED DRAWINGS:

FILENAME: CAT708

REVISION: A

DATE: 03-Aug-12

SCALE: NTS

Millimetres



© 2009 Rakon Limited

Drawing Name: Test Circuit and Output Waveform - Pluto TCXO/VCTCXO

10 PIN TEST CIRCUIT:

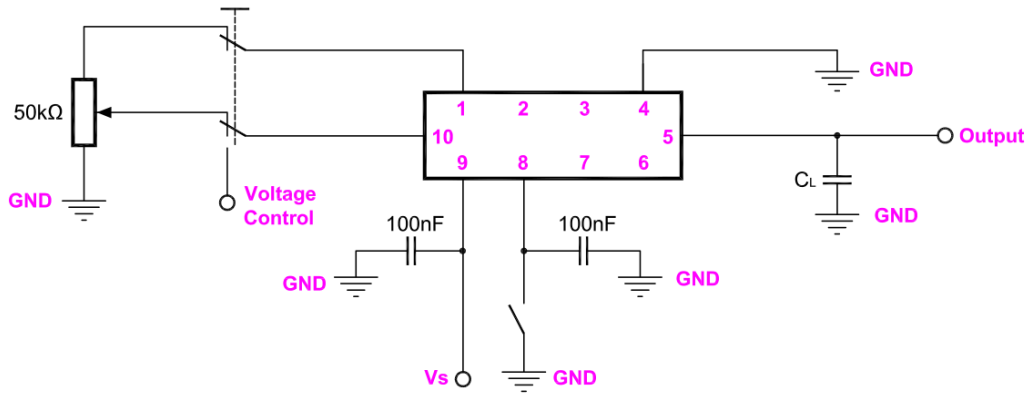

TITLE: Pluto TCXO/TCVCXO TEST CIRCUIT

FILENAME: CAT709

RELATED DRAWINGS:

REVISION: B
 DATE: 20-Jun-14
 SCALE: NTS
 Millimetres



© 2013 Rakon Limited

OUTPUT WAVEFORM - HCMOS :

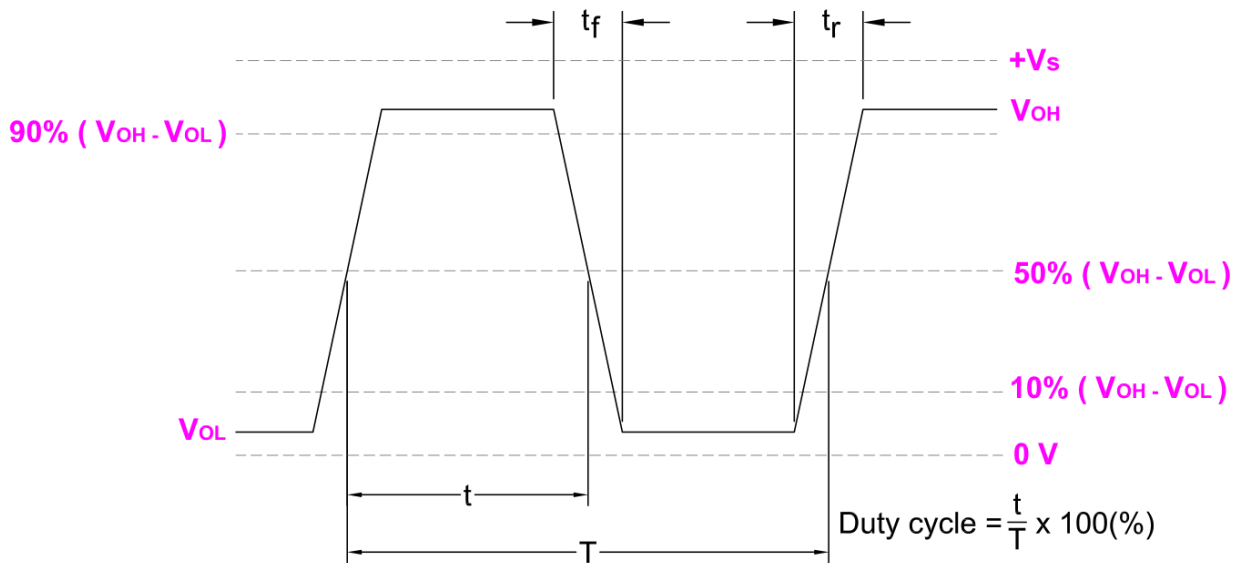

TITLE: Pluto TCXO/TCVCXO OUTPUT WAVEFORM

FILENAME: CAT710

RELATED DRAWINGS:

REVISION: B
 DATE: 20-Jun-14
 SCALE: NTS
 Millimetres



© 2013 Rakon Limited

Drawing Name: Pluto 7050 Series TCXO Reflow

Pb-Free Reflow Soldering Profile *

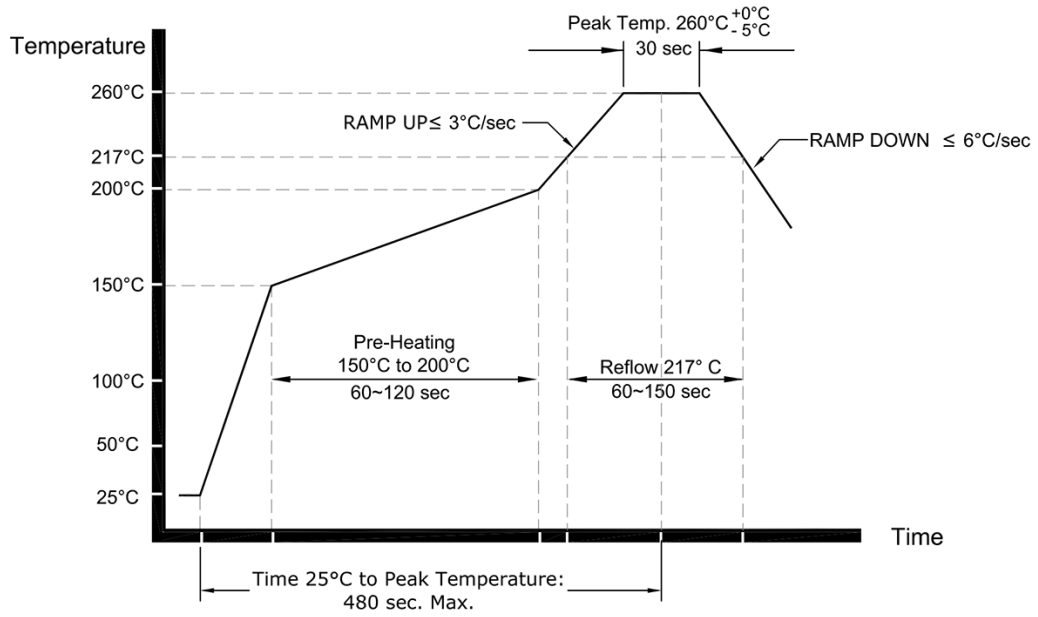

Sn-Pb Eutectic Reflow Soldering Profile *

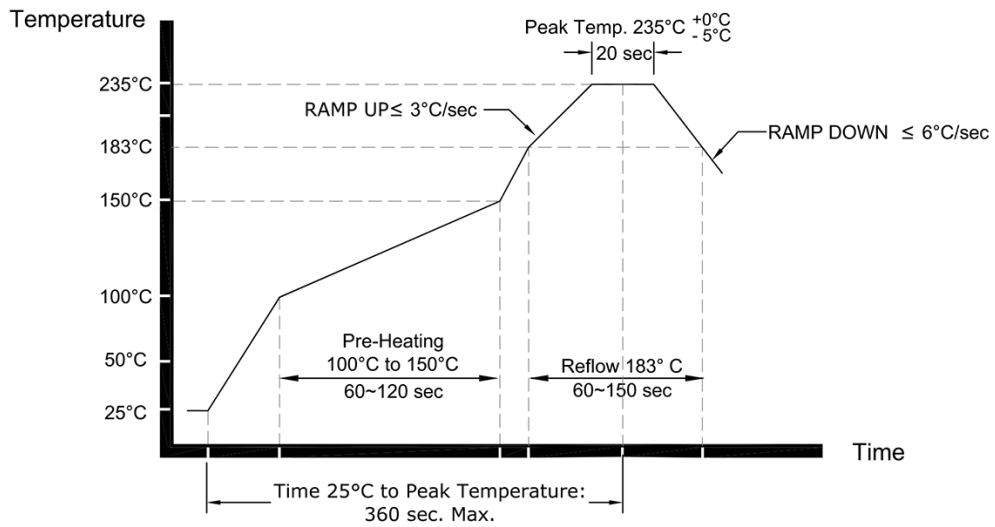

*** NOTE:**

These profile were used during the qualification testing of the product and therefore represents worst case conditions. They are not recommended for use by the customer in the actual assembly of these parts.

TITLE: Pluto 7050 Series TCXO Reflow

FILENAME: CAT711

RELATED DRAWINGS:

REVISION: B

DATE: 25-Jun-13

SCALE: NTS

Millimetres

rakon

© 2013 Rakon Limited