



M. S. KENNEDY CORP.

**RAD HARD 4.5A,
500KHz STEP DOWN
SWITCHING REGULATOR
CONTROLLER**

5059RH

4707 Dey Road Liverpool, N.Y. 13088

(315) 701-6751

FEATURES:



- Manufactured using Rad Hard RH1959MILDICE
- Radiation Hardened to 100 Krad(Si) (Method 1019.7 Condition A)
- 500KHz Constant Switching Frequency: Synchronizable to 1MHz
- 4.5A Integrated Switch
- Internal Slope Compensation
- Input Voltage Range from 4.3V to 16V
- Cycle by Cycle Current Limit
- Output Voltages Down to 1.21V
- Contact MSK for MIL-PRF-38534 Qualification

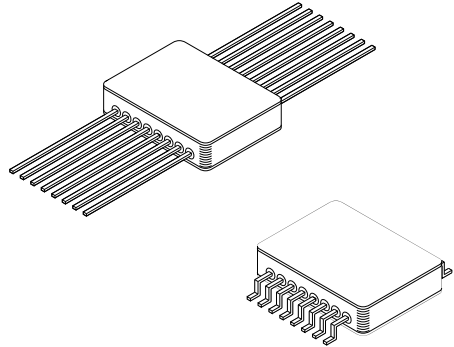

DESCRIPTION:

The MSK 5059RH is a radiation hardened 500KHz switching regulator controller capable of delivering up to 4.5A of current to the load. A fixed 500KHz switching frequency allows the use of smaller inductors reducing required board space for a given design. The 4.5A integrated switch leaves only a few application specific components to be selected by the designer. The MSK 5059RH simplifies design of high efficiency radiation hardened switching regulators that use a minimum amount of board space. The device is packaged in a hermetically sealed 16 pin flatpack and is available with straight or gull wing leads.

EQUIVALENT SCHEMATIC

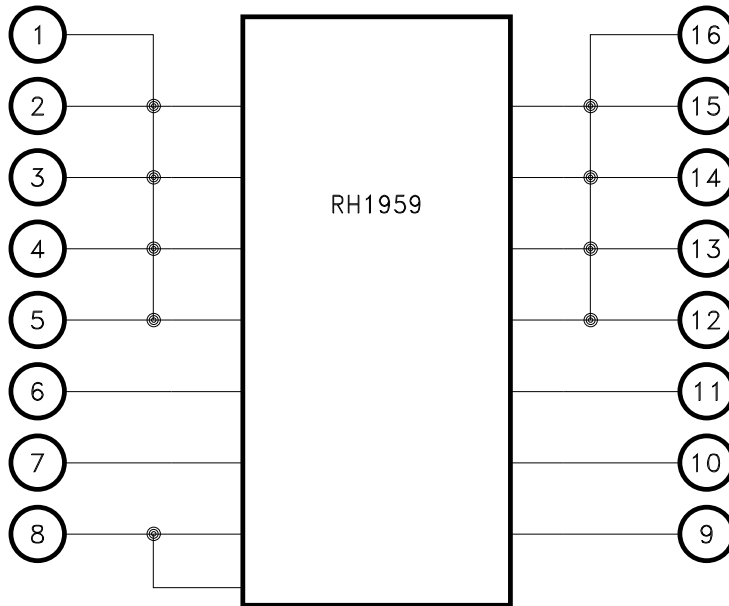

TYPICAL APPLICATIONS

- POL Applications
- Satellite System Power Supply
- Step Down Switching Regulator
- Microprocessor, FPGA Power Source
- High Efficiency Low Voltage Subsystem Power Supply

PIN-OUT INFORMATION

1	VINA	16	SWA
2	VINB	15	SWB
3	VINC	14	SWC
4	VIND	13	SWD
5	VINE	12	SWE
6	BOOST	11	SYNC
7	FB	10	SHDN
8	GND	9	VC

LT and the Linear Technology logo are registered trademarks and RH1959MILDICE is a copyright of Linear Technology Corporation

ABSOLUTE MAXIMUM RATINGS ^⑦

VIN	Input Voltage (VIN)	16V	P _D	Power Dissipation	14W
I _{OUT}	Output Current ^⑧	4.5A	T _J	Junction Temperature	+150°C
	BOOST Voltage	30V	T _{ST}	Storage Temperature Range	-65°C to +150°C
	BOOST Above Input Voltage	15V	T _{LD}	Lead Temperature Range (10 Seconds)	300°C
	SHDN Pin Voltage	7V	T _C	Case Operating Temperature	
FB	FB Pin Voltage	3.5V		MSK 5059RH	-40°C to +85°C
	FB Pin Current	1mA		MSK 5059(K/H)RH	-55°C to +125°C

ELECTRICAL SPECIFICATIONS

Parameter	Test Conditions	Group A Subgroup	MSK 5059K/H RH			MSK 5059RH			Units
			Min.	Typ.	Max.	Min.	Typ.	Max.	
Feedback Voltage	All Conditions	1,2,3	1.19	1.21	1.23	1.19	1.21	1.23	V
	Post Irradiation	1	1.18	-	1.23	1.18	-	1.23	V
Feedback Voltage Line Regulation	4.3V < V _{IN} < 15V	-0.3	-0.3	0	0.03	-0.3	0	0.03	%/V
Feedback Input Bias Current		1,2,3	-0.5	±0.2	0.5	-0.5	±0.2	0.5	uA
	Post Irradiation	1	-0.7	-	+0.7	-0.7	-	+0.7	V
V _C Pin Switching Threshold ^②	Duty Cycle = 0	1	-	0.9	-	-	0.9	-	V
V _C Pin High Clamp ^②		1	-	2.1	-	-	2.1	-	V
Switch Current Limit	V _C Open, V _{FB} = 1.05V, DC < 50%	1,2,3	4.5	6	8.5	4.5	6	8.5	A
Switch On Resistance (V _{SW} /I _{SW})	I _{SW} = 4.5A	1	-	0.09	0.11	-	0.09	0.11	Ω
		2,3	-	-	0.13	-	-	-	Ω
Maximum Switch Duty Cycle	V _{FB} = 1.05V	1	90	93	-	90	93	-	%
		2,3	86	-	-	-	-	-	%
Switch Frequency	V _C Set to Give 50% Duty Cycle	1	460	500	540	460	500	540	KHz
		2,3	440	-	560	-	-	-	KHz
	Post Irradiation	1	420	-	540	420	-	540	KHz
Switch Frequency Line Regulation	4.3V < V _{IN} < 15V	1,2,3	-0.15	0	0.15	-0.15	0	0.15	%/V
Frequency Shifting Threshold on FB Pin	Δf = 10KHz	1,2,3	0.5	0.7	1.0	0.5	0.7	1.0	V
Minimum Input Voltage ^②		1,2,3	-	4.0	4.3	-	4.0	4.3	V
Minimum Boost Voltage ^②	I _{SW} < 4.5A	1,2,3	-	2.3	3.0	-	2.3	3.0	V
Boost Current ^②	I _{SW} = 1A	1,2,3	-	20	35	-	20	35	mA
	I _{SW} = 4.5A	1,2,3	-	90	140	-	90	140	mA
Input Supply Current		1,2,3	-	3.3	5.4	-	3.3	5.4	mA
Shutdown Supply Current	V _{SHDN} = 0V, V _{SW} = 0V, V _C Open	1	-	30	50	-	30	50	uA
		2,3	-	-	75	-	-	-	uA
Lockout Threshold	V _C Open	1,2,3	2.3	2.38	2.46	2.3	2.38	2.46	V
Shutdown Threshold	V _C Open Device Shutting Down	1,2,3	0.13	0.37	0.60	0.13	0.37	0.60	V
	Device Starting Up	1,2,3	0.25	0.5	0.7	0.25	0.5	0.7	V
Synchronization Threshold		1,2,3	-	1.5	2.2	-	1.5	2.2	V
Synchronization Range		1	580	-	1000	580	-	1000	KHz
SYNC Pin Input Resistance ^②		-	-	40	-	-	40	-	Ω
Thermal Resistance ^②	Junction to Case @ 125°C	-	-	4.0	5.0	-	4.0	5.0	%C/W

NOTES:

- ① Unless otherwise specified V_{IN} = 5V, V_C = 1.5V, BOOST = V_{IN} + 5V.
- ② Guaranteed by design but not tested. Typical parameters are representative of actual device performance but are for reference only.
- ③ Industrial grade devices shall be tested to subgroup 1 unless otherwise specified.
- ④ Military grade devices ("H" and "K" suffix) shall be 100% tested to subgroups 1,2,3 and 4.
- ⑤ Subgroup 5 & 6 testing available on request.
- ⑥ Subgroup 1,4 TC = +25°C
Subgroup 2,5 TC = +125°C
Subgroup 3,6 TC = -55°C
- ⑦ Continuous operation at or above absolute maximum ratings may adversely effect the device performance and/or life cycle.
- ⑧ The absolute maximum current of 4.5A applies for duty cycles of 0.75 or lower.
De-rate linearly from 4.5A at D=0.75 to 3.375A at D=100.
- ⑨ Pre and Post irradiation limits at 25°C, up to 100 Krad(Si) TID, are identical unless otherwise specified.

APPLICATION NOTES

PIN FUNCTIONS

VIN - The VIN pins connect to the collector of the internal power switch and provide power to the internal control circuitry and internal regulator. Very high di/dt is seen at these pins during switch on and off transitions. High frequency decoupling capacitors are recommended to minimize voltage spikes. All five VIN pins should be connected to a low impedance source for best operation.

SW - The SW pins are connected to the emitter of the internal power transistor. These pins rise up to the input voltage during the on time of the switch and are driven negative when the power switch turns off. The negative voltage is clamped by the catch diode and must not go more negative than -0.8V. All five SW pins must be connected for maximum performance.

BOOST - The BOOST pin provides drive voltage greater than VIN to the base of the power transistor. Using a voltage greater than VIN ensures hard saturation of the power switch significantly improving overall efficiency. Connect a capacitor between BOOST and SW to store charge. Connect a diode between VIN and BOOST to charge the capacitor during the off time of the power switch.

FB - The FB (feedback) pin's primary function is to set the output voltage. Use a resistive divider from VOUT to GND to set the voltage at the feedback pin to 1.21V when the output voltage is at the desired level. The FB pin provides two additional functions. If the voltage at the FB pin drops below 0.8V the switch current limit is reduced. When the voltage at the FB pin drops below 0.7V the switching frequency is reduced and sync is disabled. The switching frequency reduces to approximately 100KHz at $V_{FB} < 0.4V$.

GND - The GND pin provides a return path for all internal control current and acts as a reference to the error amplifier. It is important that it is at the same voltage potential as the load return to ensure proper regulation. Keep current on the ground between the load and the MSK 5059RH to a minimum and use heavy copper traces to minimize voltage drops and regulation error.

VC - The VC pin is the output of the error amplifier and the input of the peak current comparator. This pin is typically used for frequency compensation but can also be used as a current clamp or as an override to the internal error amplifier control. The pin voltage is typically around 1V at light load and 2V at heavy load. Driving the pin low will shut down the regulator. Driving it high will increase the output current. The current into the VC pin must be limited to 4mA when driving it high.

SHDN - The SHDN (shutdown) pin has two shutdown functions. The first function disables switching when the voltage on the pin drops below 2.38V (nominal). The second forces a complete shutdown minimizing power consumption when the voltage drops below 0.4V (nominal). Pull this pin high or leave open for normal operation. The 2.38V threshold can be used for UVLO functions by configuring a resistive divider to VIN and GND that holds the pin voltage below 2.38V until VIN rises to the minimum desired voltage.

SYNC - The SYNC pin is used to synchronize the oscillator to an external clock. It is logic compatible and can be driven to any frequency between the free run frequency (500KHz nominal) and 1MHz. The duty cycle of the input signal must be between 10% and 90% to ensure proper synchronization. Tie the SYNC pin to GND if it is not used.

SETTING THE OUTPUT VOLTAGE

The output voltage of the MSK 5059RH is set with a simple resistor divider network: see Figure 1 (Typical Application Circuit). Select the resistor values to divide the desired output down to equal V_{FB} (1.21V nominal) at the FB pin. Use a 2.5K or lower value resistor for R2 to keep output error due to FB pin bias current less than 0.1%.

$$V_{OUT} = V_{FB} * (1 + R1/R2)$$

$$R1 = R2 * (V_{OUT}/V_{FB} - 1)$$

SELECTING THE INDUCTOR

The inductor is used to filter the square pulses at the SW pin to an acceptable linear ripple. The inductance value will limit the maximum available current at different input and output voltages. See "Maximum Load Current" in the typical performance curves section of this data sheet. Use the curves to make the initial value selection. Determine the peak inductor current as follows:

$$I_{PK} = I_{OUT} + V_{OUT} * (V_{IN} - V_{OUT}) / (2 * f * L * V_{IN})$$

Where:

f = the switching frequency in Hz

L = inductor value in Henries

Select an inductor what will not saturate at worst case peak current. Calculate the peak to peak inductor current ripple as follows:

$$I_{P-P} = V_{OUT} * (V_{IN} - V_{OUT}) / (f * L * V_{IN})$$

Nearly all of the current ripple will be seen by the output capacitance. See selecting the output capacitor.

SELECTING THE OUTPUT CAPACITOR

The output capacitor filters the ripple current from the inductor to an acceptable ripple voltage seen by the load. The primary factor in determining voltage ripple is the ESR of the output capacitor. The voltage ripple can be approximated as follows:

$$V_{P-P} = I_{P-P} * ESR$$

The typical ESR range for an MSK 5059RH application is between 0.05 and 0.20 ohm. Capacitors within these ESR ranges typically have enough capacitance value to make the capacitive term of the ripple equation insignificant. The capacitive term of the output voltage ripple lags the ESR term by 90° and can be calculated as follows:

$$V_{P-P}(CAP) = I_{P-P} / (8 * f * C)$$

Where:

C = output capacitance in Farads

Select a capacitor or combination of capacitors that can tolerate the worst-case ripple current with sufficient de-rating. When using multiple capacitors in parallel to achieve ESR and/or total capacitance sharing of ripple current between capacitors will be approximately equal if all of the capacitors are the same type and preferably from the same lot. Low ESR tantalum capacitors are recommended over aluminum electrolytic. The zero created by the ESR of the capacitor is necessary for loop stability. A small amount of ceramic capacitance close to the load to decouple high frequency is acceptable but it should not cancel the ESR zero.

SELECTING THE CATCH DIODE

Schottky diodes work best in the catch diode position because they switch very quickly and have low forward voltage. The diode should be rated for well above the maximum input voltage to account for the full input voltage, transients at the switch node and de-rating requirements. Transients at the switch node can be minimized with careful attention to switching current paths during board layout. The diode must be rated for the worst-case peak voltage and the average current plus any de-rating requirements. The average current can be approximated as follows:

$$I_D = I_{OUT} * (V_{IN} - V_{OUT}) / V_{IN}$$

PROVIDING BOOST DRIVE

The BOOST pin provides drive greater than VIN for the power transistor. The boost capacitor is charged through a switching diode to the input voltage when the power switch is off, see Figure 1. When the power switch turns on the SW node rises to VIN and the boost capacitor supplies current to drive the power transistor. Typically a 0.27µF capacitor will provide sufficient charge but smaller capacitors may be used. The following equation gives an approximation for the absolute minimum value but should be used with caution as it does not take all worst case and secondary factors into consideration.

$$C_{MIN} = (I_{OUT}/50) * (V_{OUT}/V_{IN}) / f * (V_{OUT} - 2.8V)$$

COMPENSATING THE LOOP

The current mode power stage from the VC node to the SW node can be modeled as a transconductance of gm = 5.3A/V. The DC output gain will be the product of the transconductance times the load resistance. As frequency increases the output capacitance rolls off the gain until the ESR zero is reached. The error amplifier can be modeled as a transconductance of 1000µMho with an output impedance of 2KΩ in parallel with 12pF. Typically a single 1000 to 2000pF capacitor is all that is needed to compensate the loop but more complex compensation schemes are readily achieved.

TYPICAL APPLICATION CIRCUIT

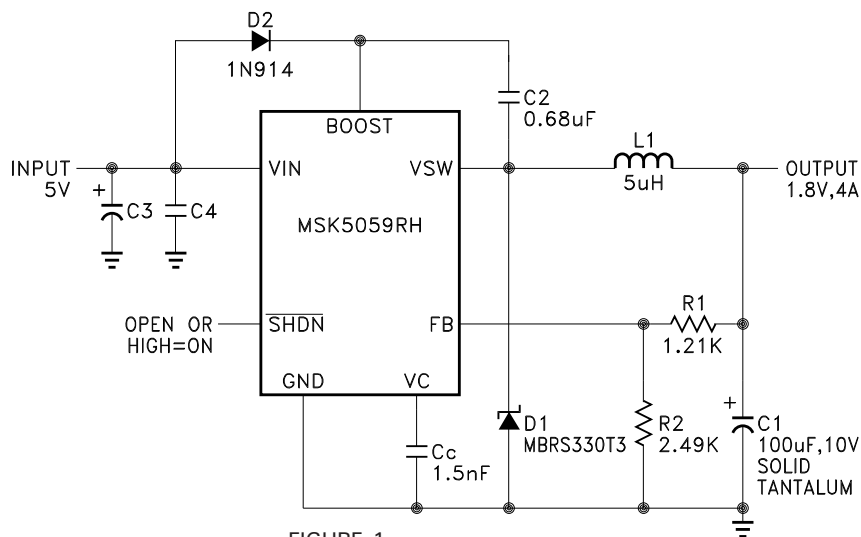
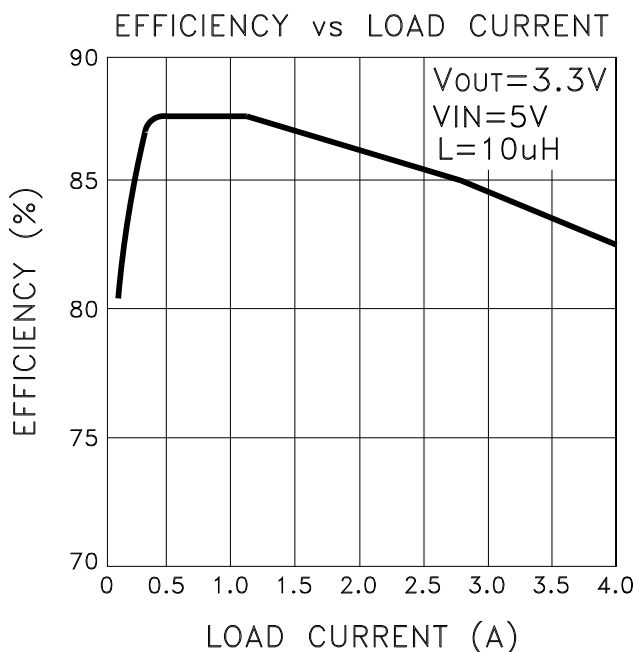

FIGURE 1

TYPICAL EFFICIENCY FOR 3.3V APPLICATION



TOTAL DOSE RADIATION TEST PERFORMANCE

Radiation performance curves for TID testing have been generated for all radiation testing performed by MS Kennedy. These curves show performance trends throughout the TID test process and are located in the MSK 5059RH radiation test report. The complete radiation test report is available in the RAD HARD PRODUCTS section on the MSK website.

<http://www.mskennedy.com/store.asp?pid=9951&catid=19680>

ADDITIONAL APPLICATION INFORMATION

For additional applications information, please reference Linear Technology Corporation's@ LT1959 data sheet.

TYPICAL PERFORMANCE CURVES

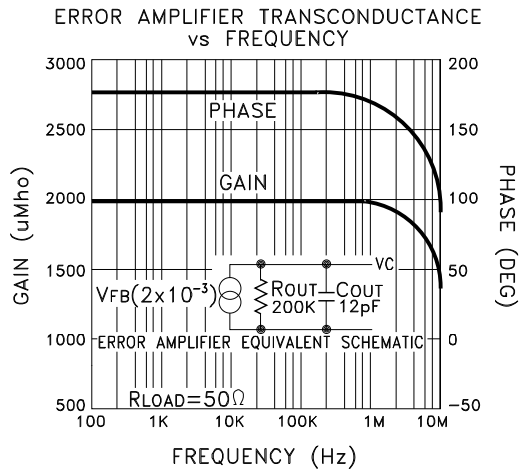
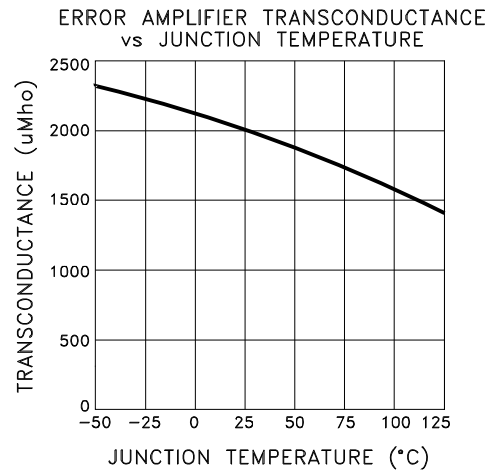
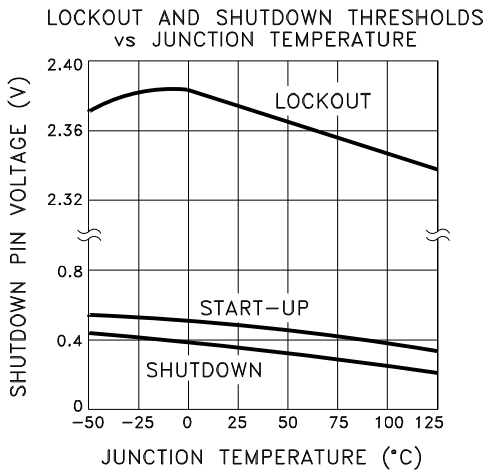
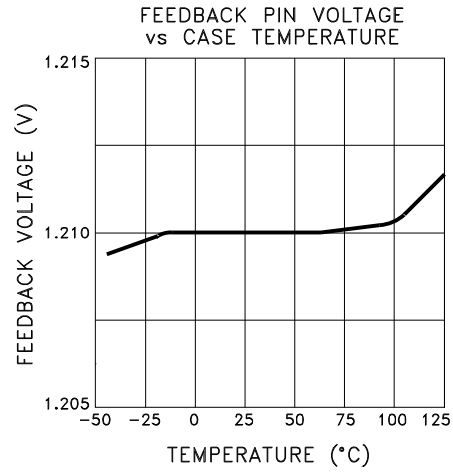
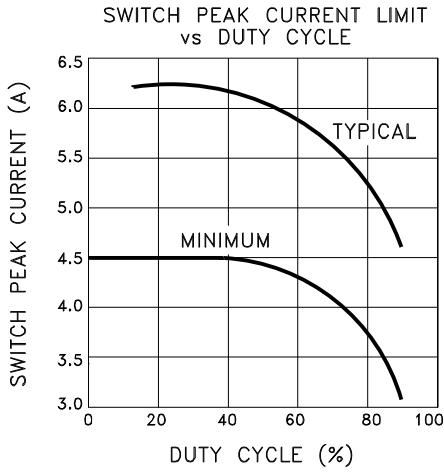

TYPICAL PERFORMANCE CURVES CONT'D

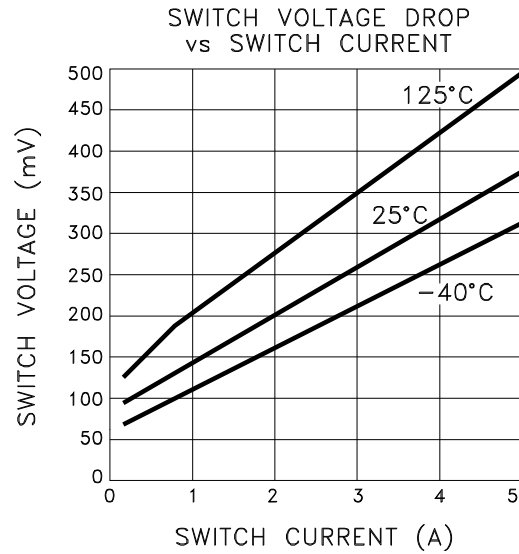
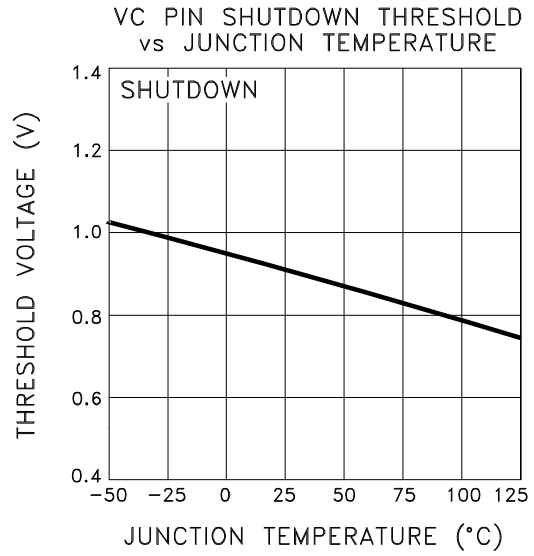
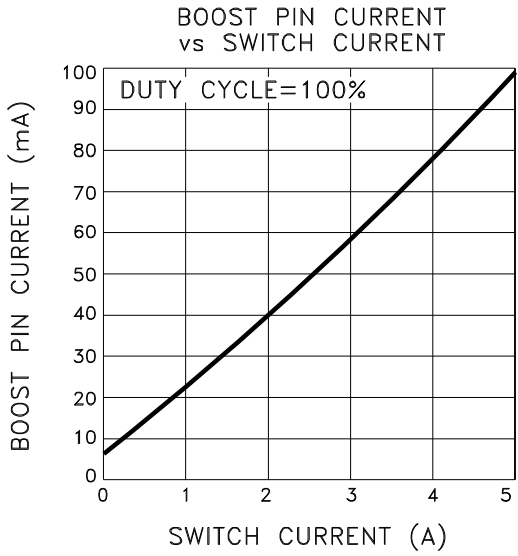
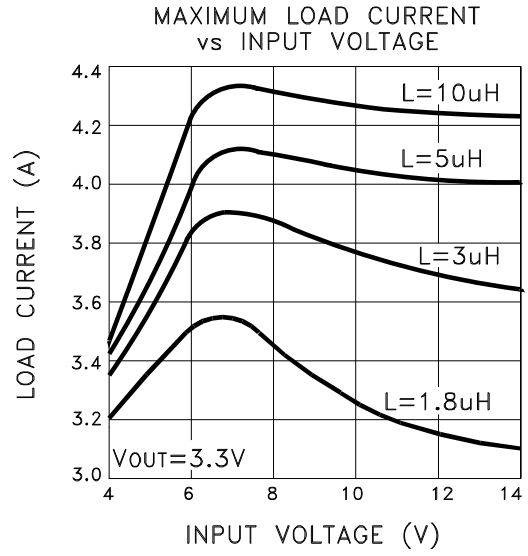
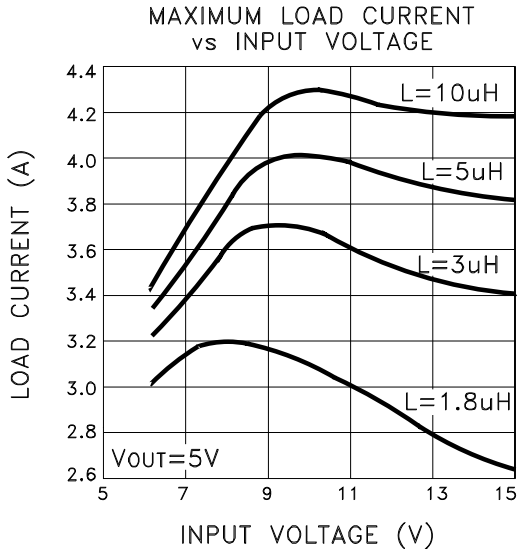

MECHANICAL SPECIFICATIONS

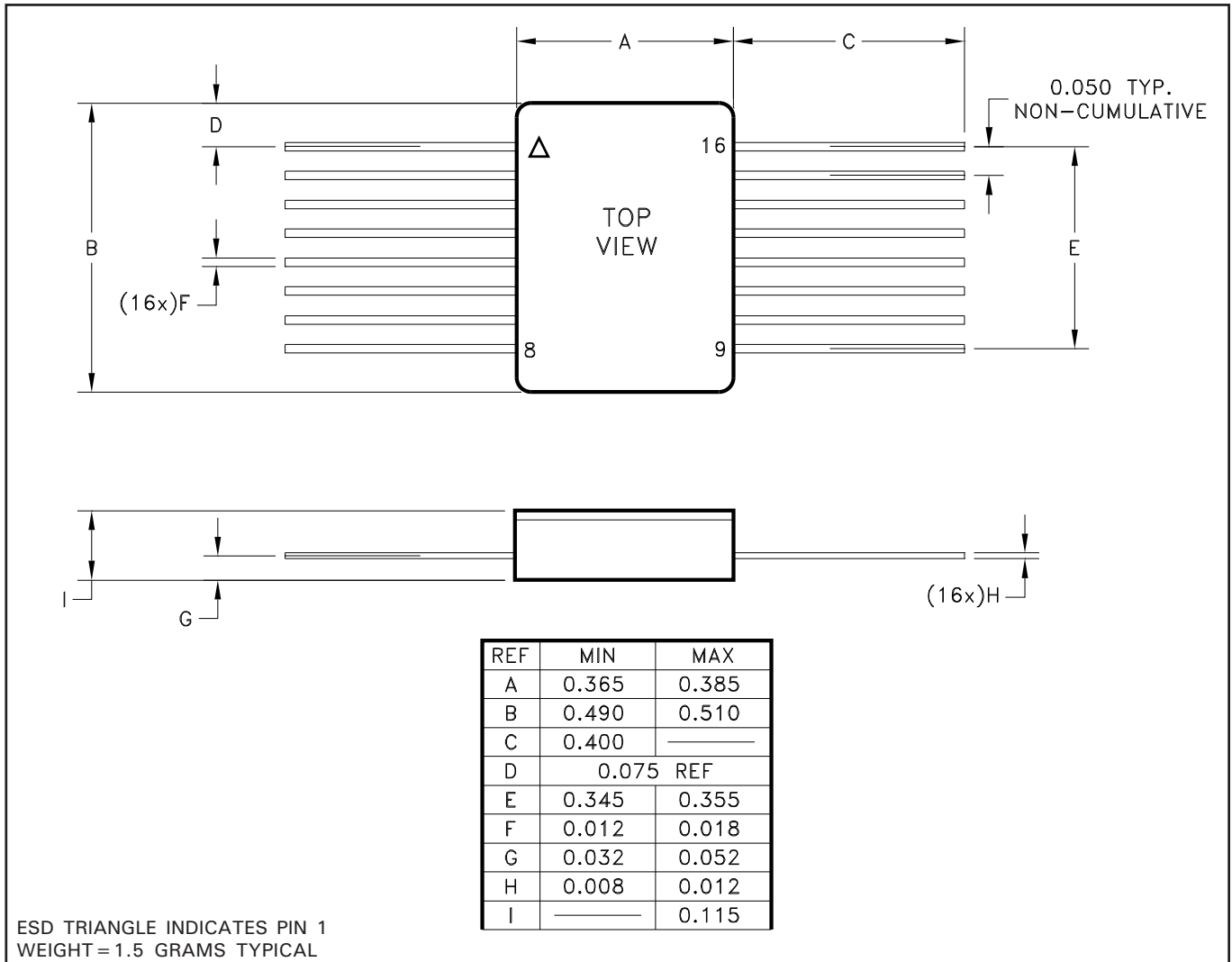

ORDERING INFORMATION

PART NUMBER	SCREENING LEVEL	LEADS
MSK5059RH	INDUSTRIAL	STRAIGHT
MSK5059HRH	MIL-PRF-38534 CLASS H	
MSK5059KRH	MIL-PRF-38534 CLASS K	

MECHANICAL SPECIFICATIONS

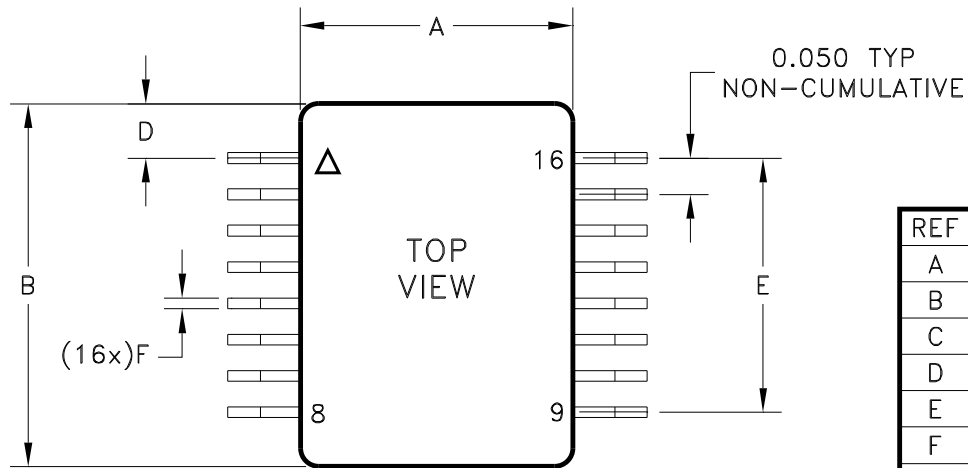

REF	MIN	MAX
A	0.365	0.385
B	0.490	0.510
C	0.045	0.055
D	0.075 REF	
E	0.345	0.355
F	0.012	0.018
G	0.050 REF	
H	0.008	0.012
I	0.115	
J	0.008	0.018
K	0.550	0.600

NOTE: "J" IS MEASURED FROM
BOTTOM OF PIN TO
BOTTOM OF CASE.

ESD TRIANGLE INDICATES PIN 1
WEIGHT = 1.5 GRAMS TYPICAL

ORDERING INFORMATION

PART NUMBER	SCREENING LEVEL	LEADS
MSK5059RHG	INDUSTRIAL	GULL WING
MSK5059HRHG	MIL-PRF-38534 CLASS H	
MSK5059KRHG	MIL-PRF-38534 CLASS K	

M.S. Kennedy Corp.
4707 Dey Road, Liverpool, New York 13088
Phone (315) 701-6751
FAX (315) 701-6752
www.mskennedy.com

The information contained herein is believed to be accurate at the time of printing. MSK reserves the right to make changes to its products or specifications without notice, however, and assumes no liability for the use of its products.

Please visit our website for the most recent revision of this datasheet.

Contact MSK for MIL-PRF-38534 qualification status.