

# NCV8460A

## Self Protected High Side Driver with Temperature Shutdown and Current Limit

The NCV8460A is a fully protected High-Side driver that can be used to switch a wide variety of loads, such as bulbs, solenoids and other actuators. The device is internally protected from an overload condition by an active current limit and thermal shutdown.

A diagnostic output reports ON and OFF state open load conditions as well as thermal shutdown.

### Features

- Short Circuit Protection
- Thermal Shutdown with Automatic Restart
- CMOS (3.3 V / 5 V) compatible control input
- Open Load Detection in On and Off State
- Diagnostic Output
- Undervoltage and Overvoltage Shutdown
- Loss of Ground Protection
- ESD protection
- Slew Rate Control for Low EMI Switching
- Very Low Standby Current
- NCV Prefix for Automotive and Other Applications Requiring Unique Site and Control Change Requirements; AEC Qualified and PPAP Capable
- These Devices are Pb-Free and are RoHS Compliant

### Typical Applications

- Switch a Variety of Resistive, Inductive and Capacitive Loads
- Can Replace Electromechanical Relays and Discrete Circuits
- Automotive / Industrial



ON Semiconductor®

<http://onsemi.com>

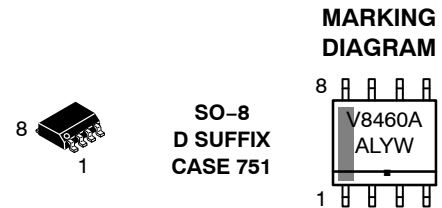

V8460A = Specific Device Code  
A = Assembly Location  
L = Wafer Lot  
Y = Year  
W = Work Week  
▪ = Pb-Free Package

### PIN CONNECTIONS

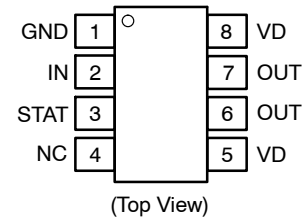

### ORDERING INFORMATION

Device	Package	Shipping†
NCV8460ADR2G	SOIC-8 (Pb-Free)	2500 / Tape & Reel

†For information on tape and reel specifications, including part orientation and tape sizes, please refer to our Tape and Reel Packaging Specifications Brochure, BRD8011/D.

# NCV8460A

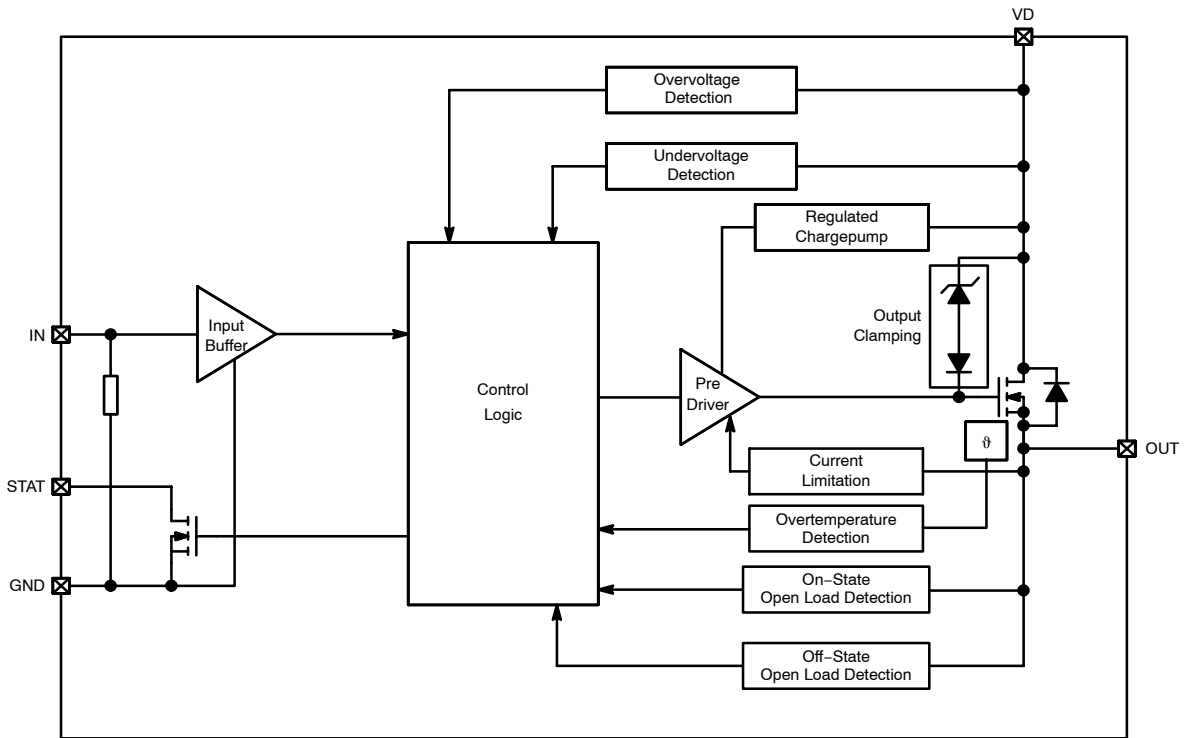

Figure 1. Block Diagram

## PIN DESCRIPTION

Pin #	Symbol	Description
1	GND	Ground
2	IN	Logic Level Input
3	STAT	Status Output
4	N/C	No Connection
5	V <sub>D</sub>	Supply Voltage
6	OUT	Output
7	OUT	Output
8	V <sub>D</sub>	Supply Voltage

# NCV8460A

## MAXIMUM RATINGS

Rating	Symbol	Value		Unit
		Min	Max	
DC Supply Voltage	$V_D$	-16	42	V
Peak Transient Input Voltage (Load Dump 51.5 V, $V_D = 13.5$ V, ISO7637-2 pulse 5)	$V_{peak}$		65	V
Input Voltage	$V_{in}$	-8	8	V
Input Current	$I_{in}$	-5	5	mA
Output Current (Note 1)	$I_{out}$	-6	Internally Limited	A
Negative Ground Current	$-I_{gnd}$	-200	-	mA
Status Current	$I_{status}$	-5	5	mA
Power Dissipation, $T_c = 25^\circ\text{C}$	$P_{tot}$	1.183		W
Electrostatic Discharge (HBM Model 100 pF / 1500 $\Omega$ )				DC
Input		4		kV
Status		3.5		kV
Output		5		kV
$V_D$		5		kV
Single Pulse Inductive Load Switching Energy (Note 2) ( $L = 1.8$ mH, $V_{bat} = 13.5$ V; $I_L = 9$ A, $T_{Jstart} = 150^\circ\text{C}$ )	$E_{AS}$	100		mJ
Operating Junction Temperature	$T_J$	-40	+150	$^\circ\text{C}$
Storage Temperature	$T_{storage}$	-55	+150	$^\circ\text{C}$

Stresses exceeding Maximum Ratings may damage the device. Maximum Ratings are stress ratings only. Functional operation above the Recommended Operating Conditions is not implied. Extended exposure to stresses above the Recommended Operating Conditions may affect device reliability.

- Reverse Output current has to be limited by the load to stay within absolute maximum ratings and thermal performance.
- Not subjected to production testing.

## THERMAL RESISTANCE RATINGS

Parameter	Symbol	Max Value	Unit
Thermal Resistance Junction-to-Lead	$R_{\theta JL}$	72	$^\circ\text{C/W}$
Junction-to-Ambient (min. Pad)	$R_{\theta JA}$	110.8	$^\circ\text{C/W}$
Junction-to-Ambient (1" square pad size, FR-4, 1 oz Cu)	$R_{\theta JA}$	105.6	$^\circ\text{C/W}$

# NCV8460A

## ELECTRICAL CHARACTERISTICS ( $8 \leq V_D \leq 36$ V; $-40^\circ\text{C} < T_J < 150^\circ\text{C}$ unless otherwise specified)

Rating	Symbol	Conditions	Value			Unit
			Min	Typ	Max	
Operating Supply Voltage	$V_D$		6	-	36	V
Undervoltage Shutdown	$V_{UV}$		3	5	6	V
Undervoltage	$V_{UV\_Rst}$				6.5	V
Overshoot Shutdown	$V_{OV}$		36			V
On Resistance	$R_{ON}$	$I_{out} = 2$ A; $T_J = 25^\circ\text{C}$ , $V_D > 8$ V $I_{out} = 2$ A, $V_D > 8$ V			60 120	m $\Omega$
Standby Current	$I_D$	Off State, $V_{in} = V_{out} = 0$ V, $V_D = 13.5$ V On State; $V_{in} = 5$ V, $V_D = 13.5$ V, $I_{out} = 0$ A		10 1.5	20 3.5	$\mu$ A mA
Output Leakage Current	$I_L$	$V_{in} = V_{out} = 0$ V $V_{in} = 0$ V, $V_{out} = 3.5$ V $V_{in} = V_{out} = 0$ V, $V_D = 13.5$ V	-20		50 10 3	$\mu$ A

### INPUT CHARACTERISTICS

Input Voltage – Low	$V_{in\_low}$				1.25	V
Input Current – Low	$I_{in\_low}$	$V_{in} = 1.25$ V	1			$\mu$ A
Input Voltage – High	$V_{in\_high}$		3.25			V
Input Current – High	$I_{in\_high}$	$V_{in} = 3.25$ V			10	$\mu$ A
Input Hysteresis Voltage	$V_{hyst}$		0.25			V
Input Clamp Voltage	$V_{in\_cl}$	$I_{in} = 1$ mA $I_{in} = -1$ mA	11 -13	12 -12	13 -11	V

### SWITCHING CHARACTERISTICS

Turn-On Delay Time	$t_{d\_on}$	to 10% $V_{out}$ , $V_D = 13.5$ V, $R_L = 6.5$ $\Omega$		40		$\mu$ s
Turn-Off Delay Time	$t_{d\_off}$	to 90% $V_{out}$ , $V_D = 13.5$ V, $R_L = 6.5$ $\Omega$		30		$\mu$ s
Slew Rate On	$dV_{out} / dt_{on}$	10% to 80% $V_{out}$ , $V_D = 13.5$ V, $R_L = 6.5$ $\Omega$		0.9		V / $\mu$ s
Slew Rate Off	$dV_{out} / dt_{off}$	90% to 10% $V_{out}$ , $V_D = 13.5$ V, $R_L = 6.5$ $\Omega$		0.7		V / $\mu$ s

### OUTPUT DIODE CHARACTERISTICS (Note 3)

Forward Voltage	$V_F$	$I_{out} = -1.3$ A, $T_J = 150^\circ\text{C}$			0.6	V
-----------------	-------	---	--	--	-----	---

### STATUS PIN CHARACTERISTICS

Status Output Voltage Low	$V_{stat\_low}$	$I_{stat} = 1.6$ mA		0.2	0.5	V
Status Leakage Current	$I_{stat\_leakage}$	$V_{stat} = 5$ V		1	10	$\mu$ A
Status Pin Input Capacitance	$C_{stat}$	$V_{stat} = 5$ V (Note 3)			100	pF
Status Clamp Voltage	$V_{stat\_cl}$	$I_{stat} = 1$ mA $I_{stat} = -1$ mA	10 -2.2	11 -1.2	12 -0.6	V

### PROTECTION FUNCTIONS (Note 4)

Temperature Shutdown (Note 3)	$T_{SD}$		150	175	200	$^\circ\text{C}$
Temperature Shutdown Hysteresis (Note 3)	$T_{SD\_hyst}$		7	15		$^\circ\text{C}$
Output Current Limit	$I_{lim}$	$8$ V < $V_D$ < $36$ V	6	9	15	A
		$6$ V < $V_D$ < $36$ V			15	A
Status Delay in Overload	$t_{d\_stat}$				20	$\mu$ s
Switch Off Output Clamp Voltage	$V_{clamp}$	$I_{out} = 2$ A, $V_{in} = 0$ V, $L = 6$ mH	$V_D - 41$	$V_D - 45$	$V_D - 55$	V

3. Not subjected to production testing

4. To ensure long term reliability under heavy overload or short circuit conditions, protection and related diagnostic signals must be used together with a proper hardware/software strategy. If the devices operates under abnormal conditions this hardware/software solutions must limit the duration and number of activation cycles.

# NCV8460A

## ELECTRICAL CHARACTERISTICS ( $8 \leq V_D \leq 36 \text{ V}$ ; $-40^\circ\text{C} < T_J < 150^\circ\text{C}$ unless otherwise specified)

Rating	Symbol	Conditions	Value			Unit
			Min	Typ	Max	
<b>DIAGNOSTICS CHARACTERISTICS</b>						
Openload On State Detection Threshold	$I_{OL1}$	$V_{in} = 5 \text{ V}, T_J > 25^\circ\text{C}$	30		300	mA
Openload On State Detection Threshold	$I_{OL2}$	$V_{in} = 5 \text{ V}, T_J < 25^\circ\text{C}$	30		350	mA
Openload On State Detection Delay	$t_{d\_OL\_on}$	$I_{out} = 0 \text{ A}$			220	$\mu\text{s}$
Openload Off State Detection Threshold	$V_{OL}$	$V_{in} = 0 \text{ V}$	1.5	-	3.5	V
Openload Detection Delay at Turn Off	$t_{d\_OL\_off}$				1000	$\mu\text{s}$

3. Not subjected to production testing

4. To ensure long term reliability under heavy overload or short circuit conditions, protection and related diagnostic signals must be used together with a proper hardware/software strategy. If the device operates under abnormal conditions this hardware/software solutions must limit the duration and number of activation cycles.

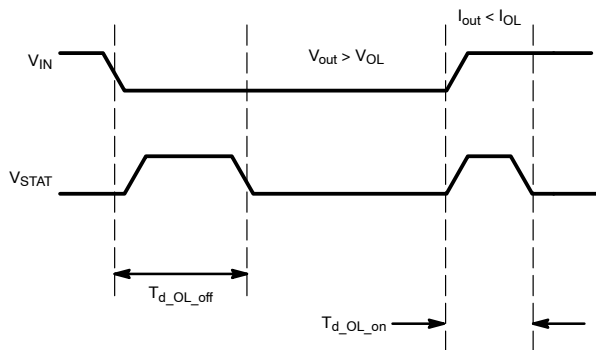

**Figure 2. Open Load Status Timing (with external pull-up)**

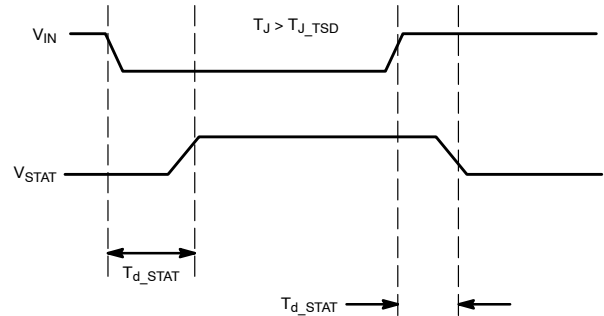

**Figure 3. Overtemperature Status Timing**

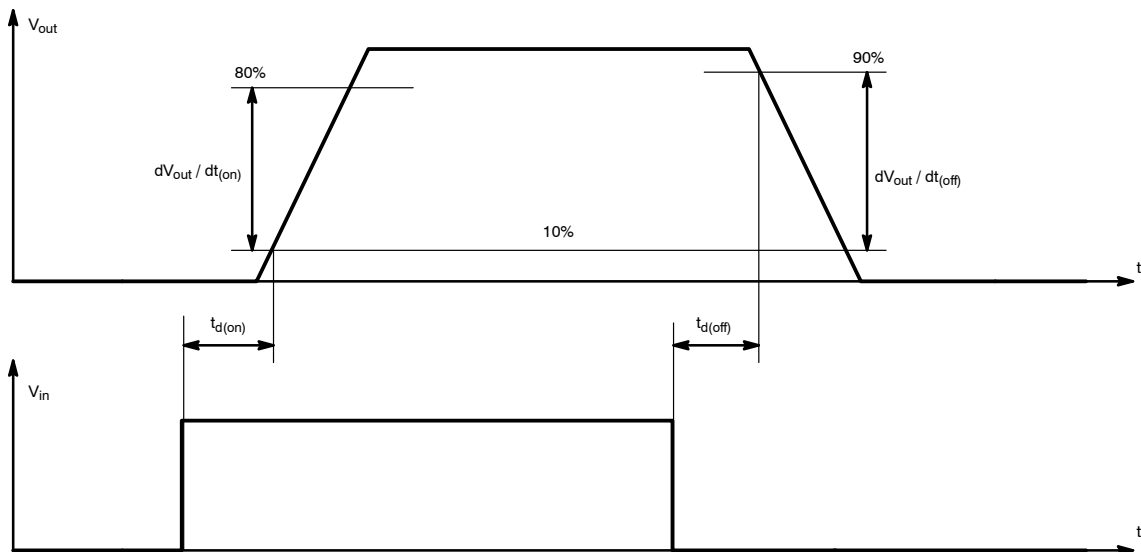

**Figure 4. Switching Timing Diagram**

# NCV8460A

**STATUS PIN TRUTH TABLE**

Conditions	Input	Output	Status
Normal Operation	L H	L H	H H
Undervoltage	L H	L L	X X
Overvoltage	L H	L L	H H
Current Limitation	L H H	L X X	H ( $T_J < T_{SD}$ ) H ( $T_J > T_{SD}$ ) L
Overtemperature	L H	L L	H L
Output Voltage > $V_{OL}$	L H	H H	L H
Output Current < $I_{OL}$	L H	L H	H L

# NCV8460A

## TYPICAL CHARACTERISTICS CURVES

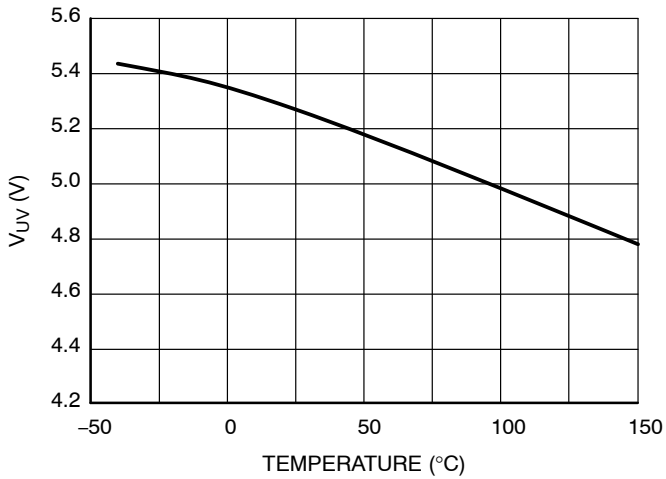

**Figure 5. Undervoltage Shutdown vs. Temperature**

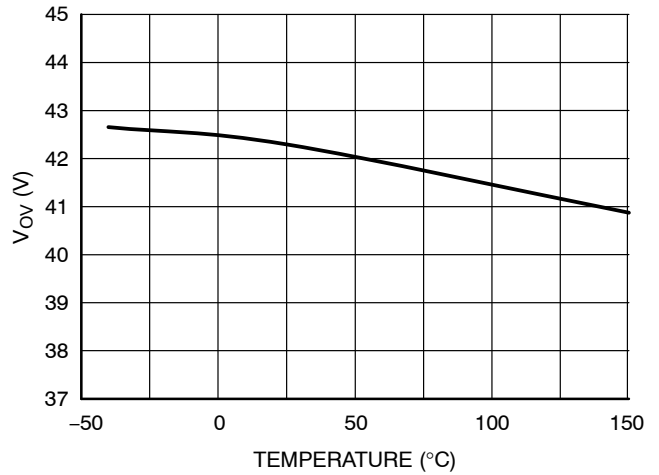

**Figure 6. Overvoltage Shutdown vs. Temperature**

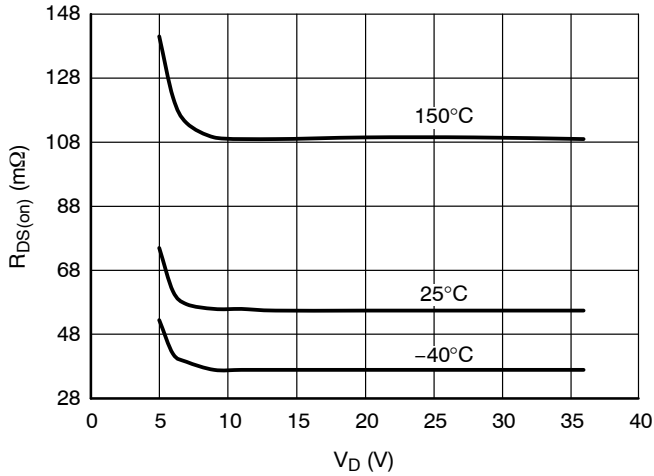

**Figure 7. R<sub>DS(on)</sub> vs. V<sub>D</sub>**

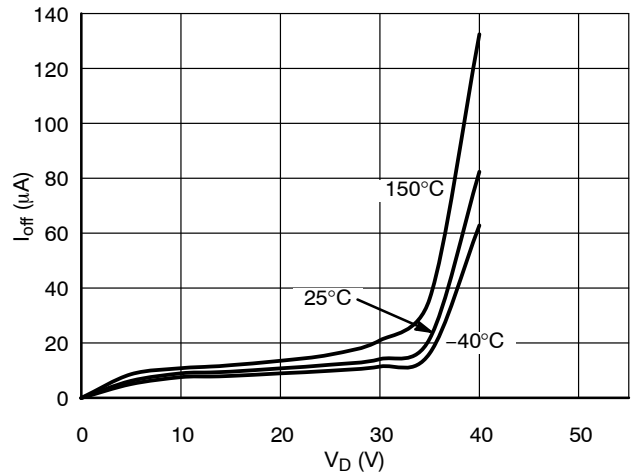

**Figure 8. OFF State Standby Current vs. V<sub>D</sub>**

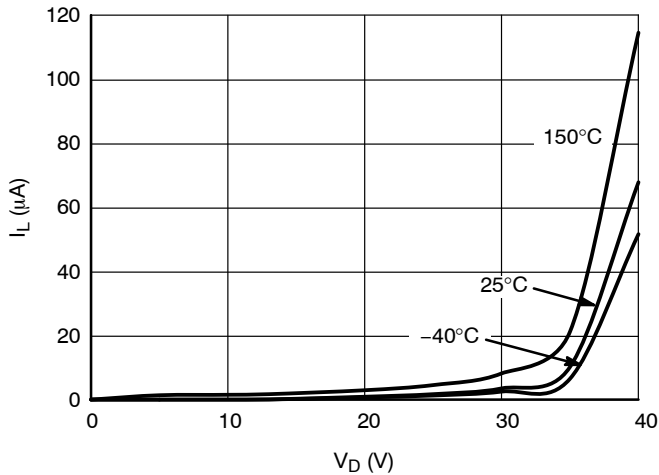

**Figure 9. Output Leakage vs. V<sub>D</sub>  
V<sub>out</sub> = 0 V**

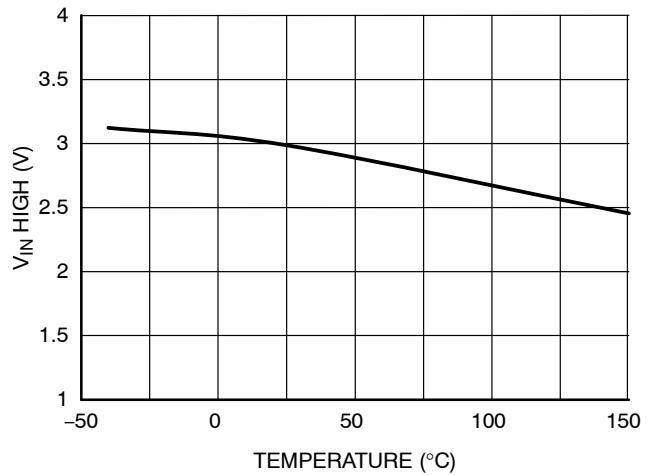

**Figure 10. V<sub>in</sub> Threshold High vs. Temperature**

# NCV8460A

## TYPICAL CHARACTERISTICS CURVES

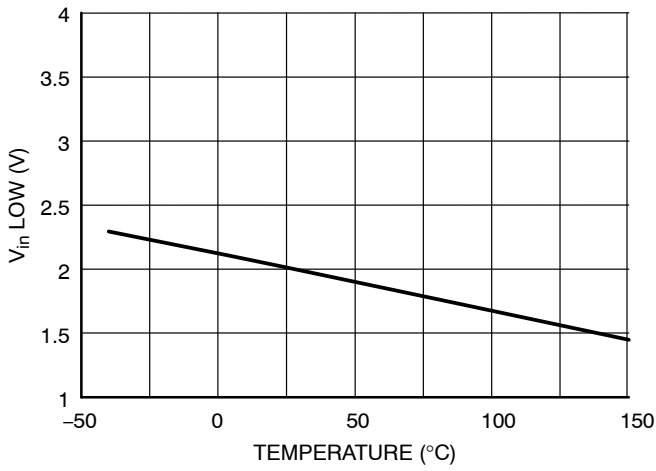

Figure 11.  $V_{in}$  Threshold Low vs. Temperature

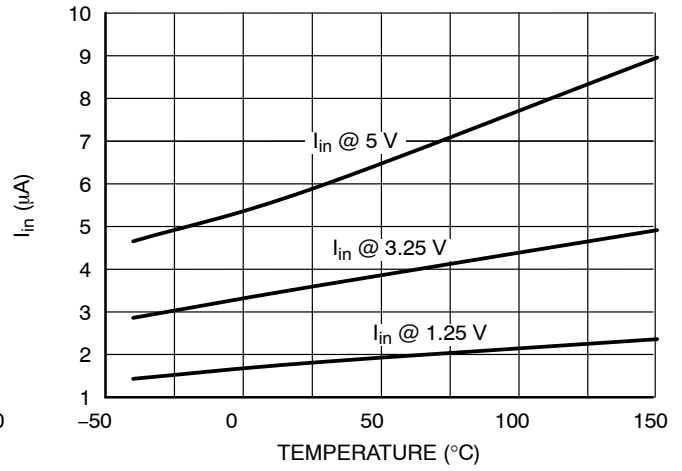

Figure 12. Input Current vs. Temperature

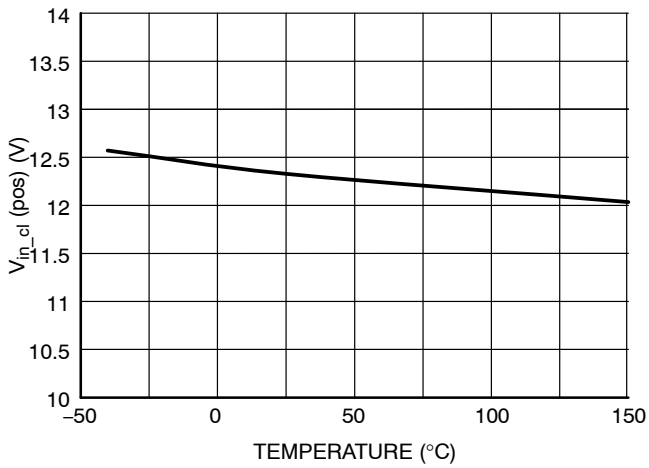

Figure 13. Input Clamp Voltage (Positive) vs. Temperature

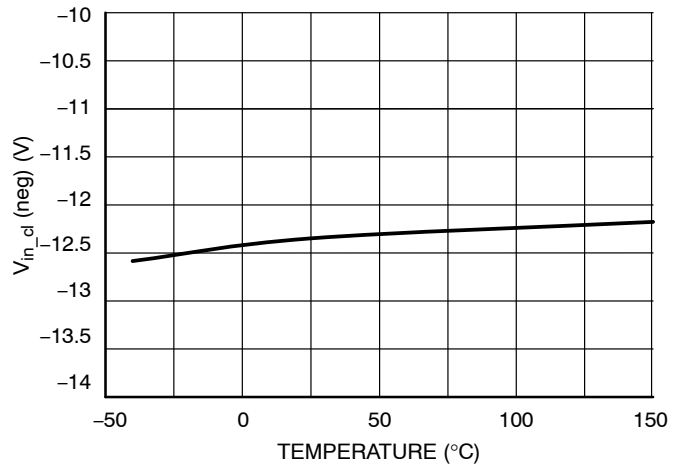

Figure 14. Input Clamp Voltage (Negative) vs. Temperature

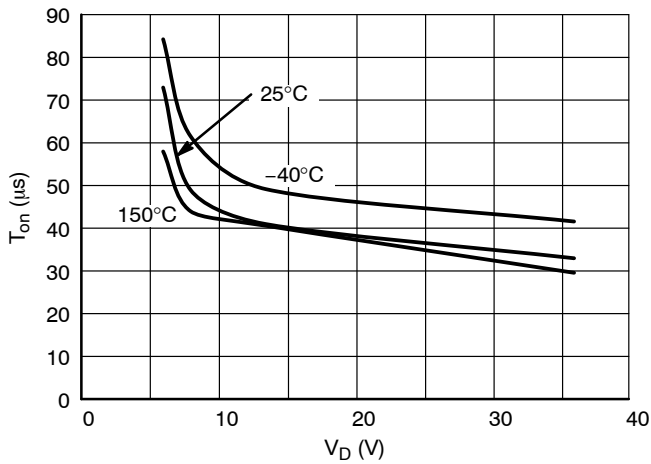

Figure 15. Turn On Time vs.  $V_D$

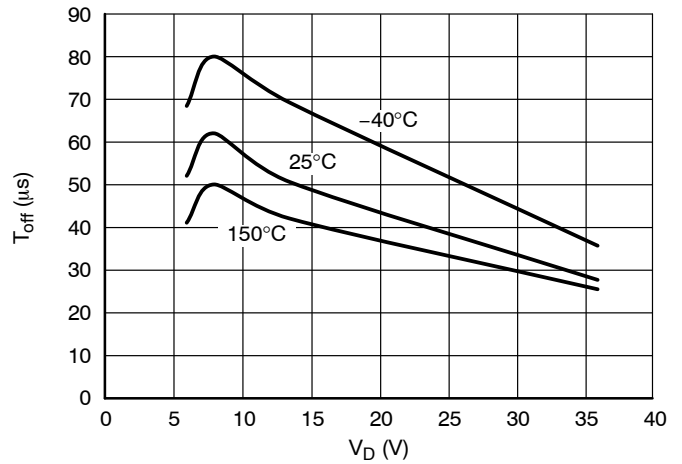

Figure 16. Turn Off Time vs.  $V_D$



# NCV8460A

## TYPICAL CHARACTERISTICS CURVES

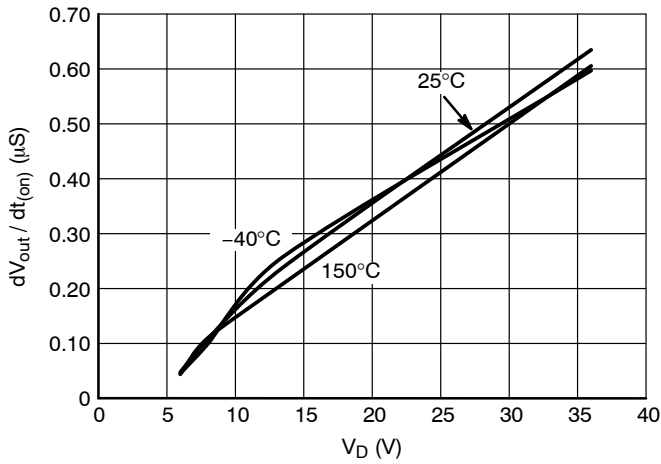

Figure 17. Slew Rate ON vs.  $V_D$

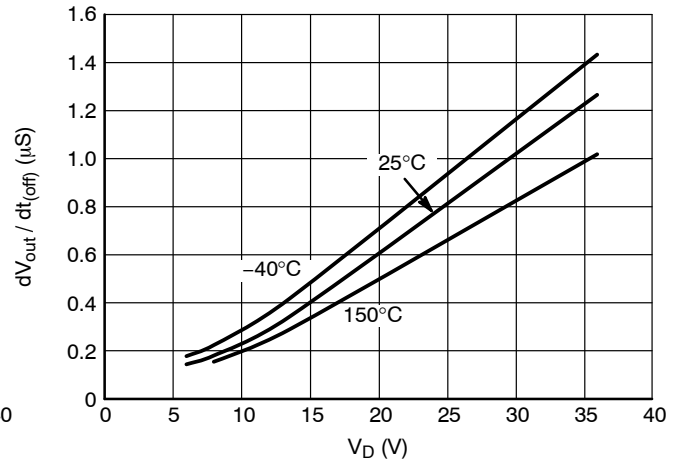

Figure 18. Slew Rate OFF vs.  $V_D$

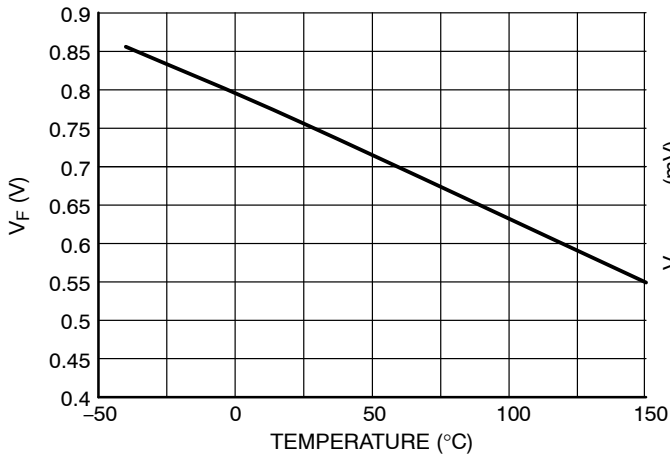

Figure 19. Forward Voltage (@ -1.3 A) vs. Temperature

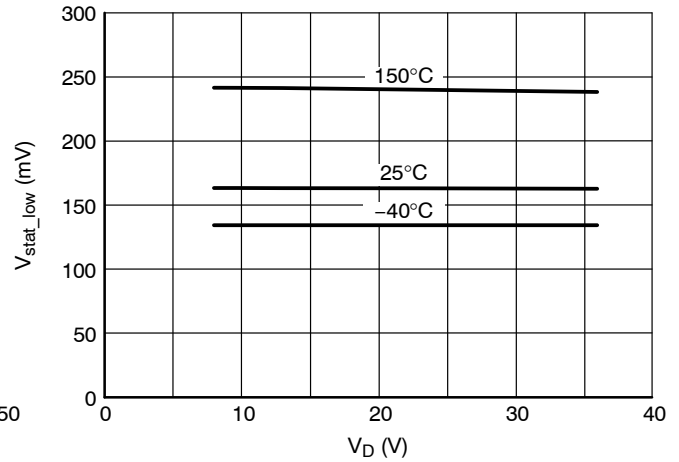

Figure 20. STAT Low Voltage vs.  $V_D$

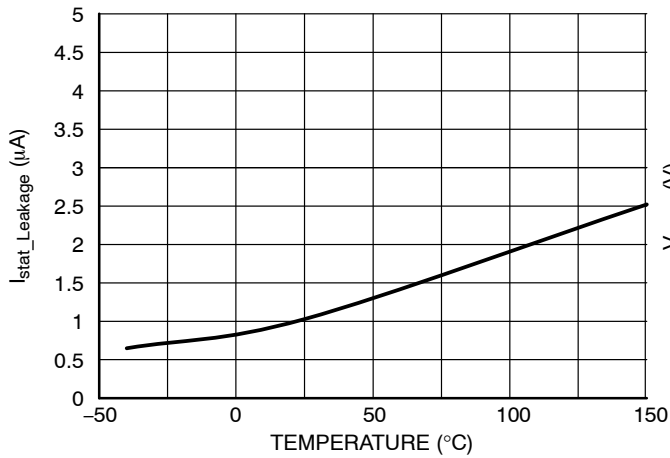

Figure 21. Status Leakage Current vs. Temperature

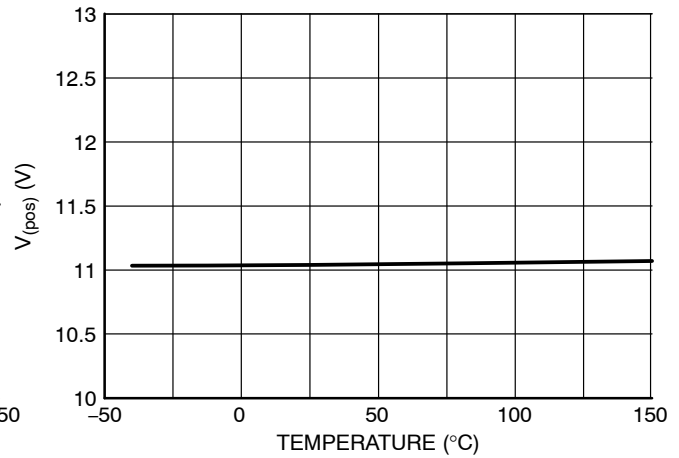

Figure 22. Status Clamp Voltage (Positive) vs. Temperature

TYPICAL CHARACTERISTICS CURVES

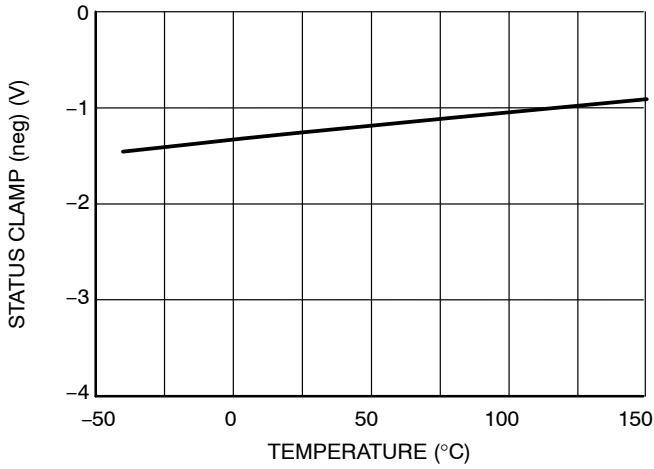

Figure 23. Status Clamp Voltage (Negative) vs. Temperature

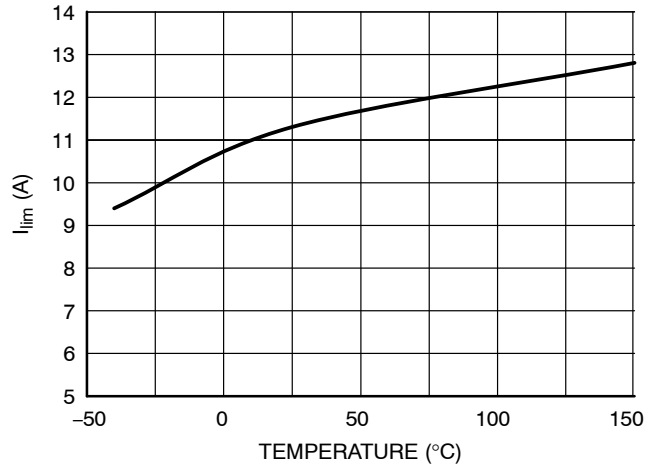

Figure 24. Current Limit vs. Temperature  
 $V_D = 13.5\text{ V}$

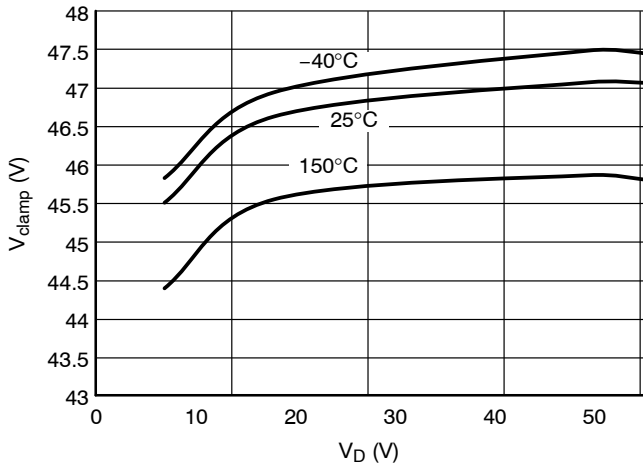

Figure 25. Turn Off Output Clamp Voltage vs.  $V_D$  and Temperature

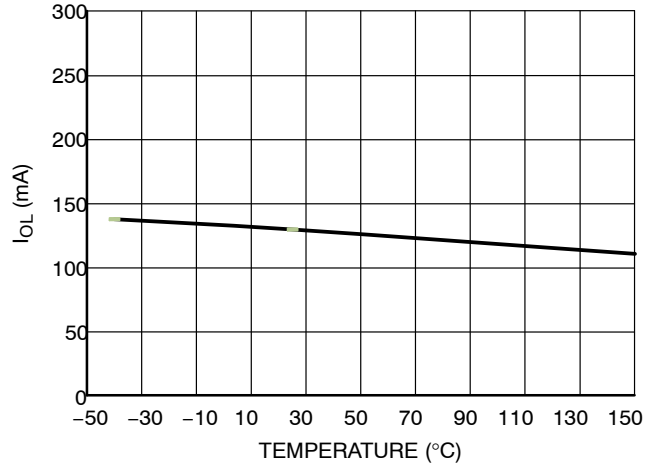

Figure 26. ON State Open Load Detection vs. Temperature  
 $V_D = 13.5\text{ V}$

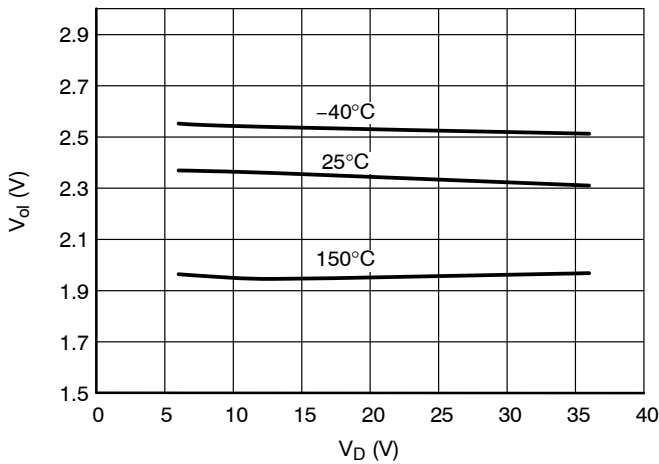

Figure 27. Off State OL Detection Threshold vs.  $V_D$  and Temperature

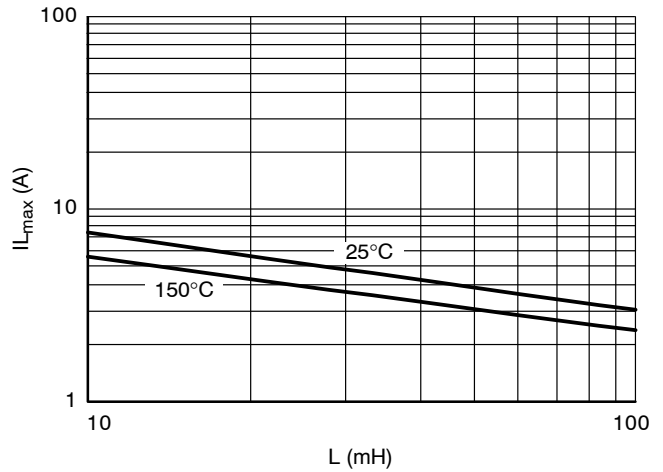

Figure 28. Single-Pulse Maximum Switch-off Current vs. Load Inductance

# NCV8460A

## TYPICAL CHARACTERISTICS CURVES

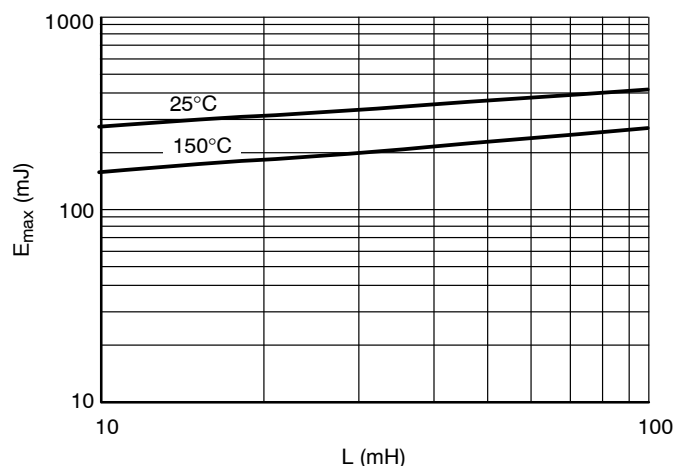

Figure 29. Single-Pulse Maximum Switch-off Current vs. Load Inductance

## ISO 7637-2: 2004(E) PULSE TEST RESULTS

ISO 7637-2:2004(E)	Test Levels				Delays and Impedance
Test Pulse	I	II	III	IV	
1	g	g	-75 V	-100 V	2 ms, 10 Ω
2a	g	g	+37 V	+50 V	0.05 ms, 10 Ω
3a	g	g	-112 V	-150 V	0.1 μs, 50 Ω
3b	g	g	+75 V	+100 V	0.1 μs, 50 Ω
4	g	g	-6 V	-7 V	5 s, .01 Ω
5 (Load Dump)	g	g	+65 V	+87 V	400 ms, 2 Ω

ISO 7637-2:2004(E)	Test Results			
Test Pulse	I	II	III	IV
1			C	C
2a			C	C
3a			C	C
3b			C	C
4			A	A
5 (Load Dump)			C	E

Class	Functional Status
A	All functions of a device perform as designed during and after exposure to disturbance.
B	All functions of a device perform as designed during exposure. However, one or more of them can go beyond specified tolerance. All functions return automatically to within normal limits after exposure is removed. Memory functions shall remain class A.
C	One or more functions of a device do not perform as designed during exposure but return automatically to normal operation after exposure is removed.
D	One or more functions of a device do not perform as designed during exposure and do not return to normal operation until exposure is removed and the device is reset by simple
E	One or more functions of a device do not perform as designed during and after exposure and cannot be returned to proper operation without replacing the device.

# NCV8460A

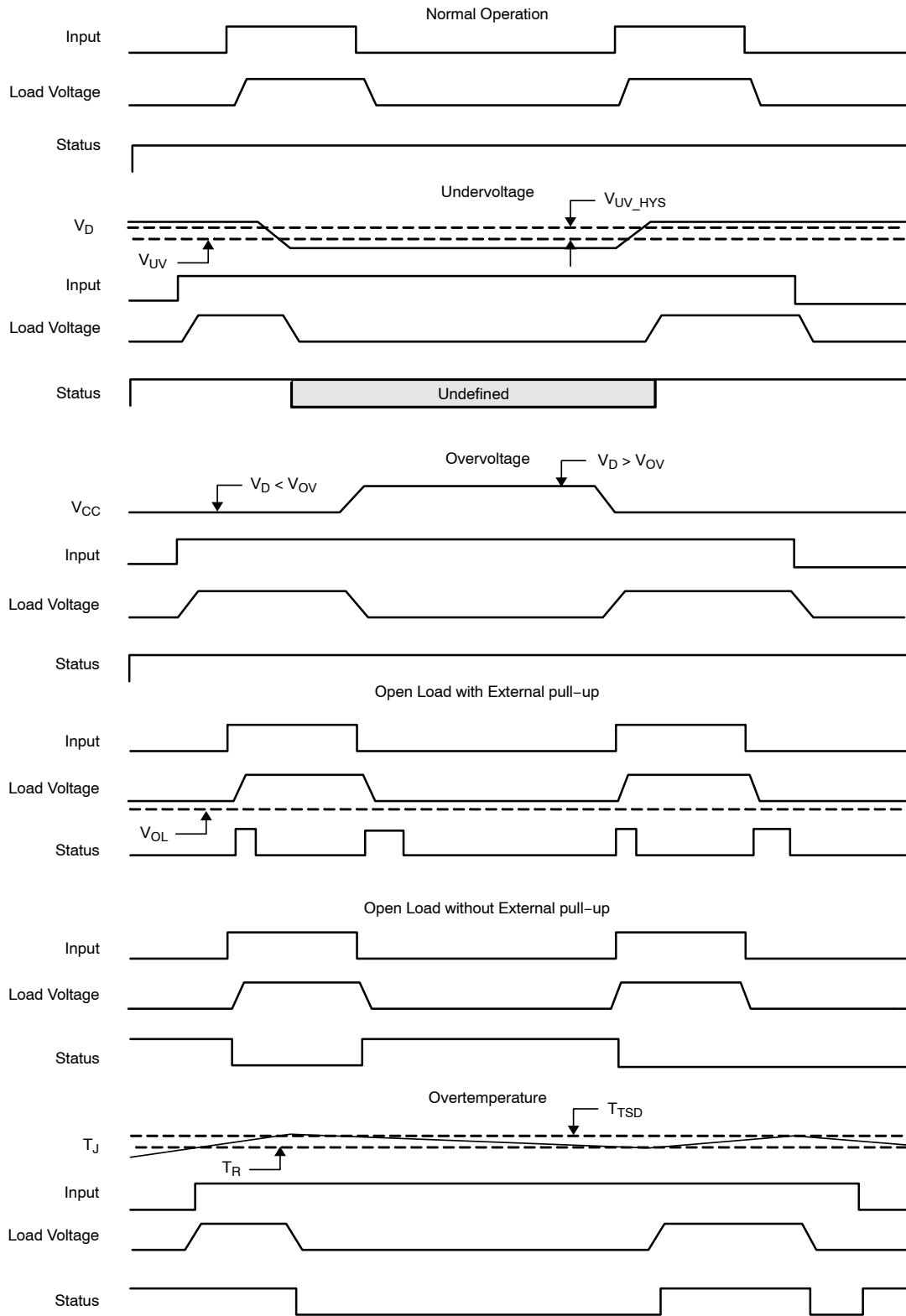

**Figure 30. Waveforms**

## NCV8460A

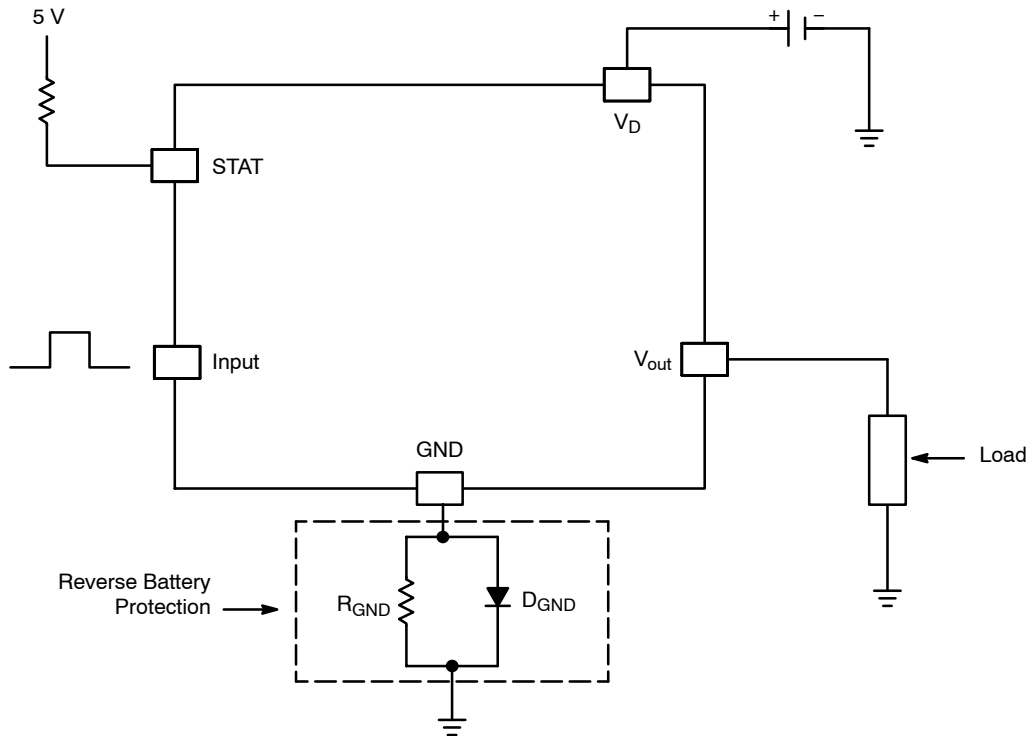

Figure 31. Application Diagram

### Reverse Battery Protection

An external resistor  $R_{GND}$  is required to adequately protect the device from a Reverse Battery event. The resistor value can be calculated using the following two formulas.

1.  $R_{GND} \geq 600 \text{ mV} / (I_d \text{ (on) max})$
2.  $R_{GND} \geq (-V_D) / (-I_{gnd})$

Maximum  $(-I_{gnd})$  current, which is the reverse GND pin current, can be found in the Maximum Ratings section. Several High Side Devices can share same the reverse battery protection resistor. Please note that the sum of  $(I_d \text{ (on) max})$  of all devices should be used to calculate  $R_{GND}$  value. If the microprocessor ground is not common with the device ground,  $R_{GND}$  will produce a voltage offset  $((I_d \text{ (on) max}) \times R_{GND})$  with respect to the IN and STAT pins.

This offset will be increased when more than one device shares the resistor.

Power Dissipation during a reverse battery event is equal to:

$$P_D = (-V_D)^2 / R_{GND}$$

In the case of high power dissipation due to several devices sharing  $R_{GND}$ , it is recommended to place a diode  $D_{GND}$  in the ground path as an alternate reverse battery protection method. When driving an inductive load, a 1 k $\Omega$  resistor should be placed in parallel with the  $D_{GND}$  diode. This method will also produce a voltage offset of ~600 mV with respect to the IN and STAT pins. This diode can also be shared amongst several High Side Devices. This voltage offset will vary if  $D_{GND}$  is shared by multiple devices.

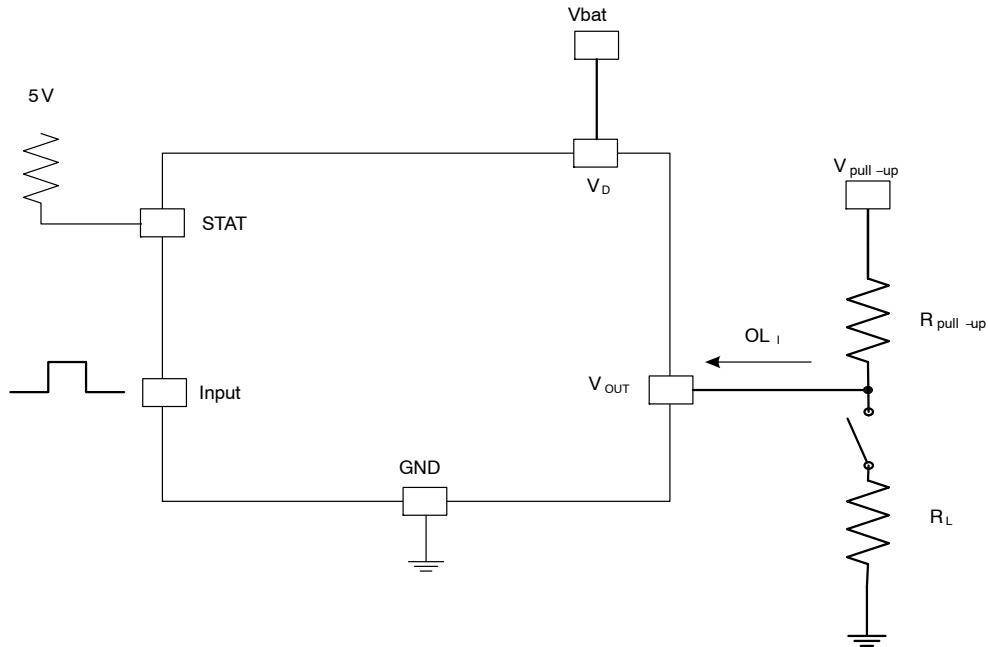

Figure 32. Open Load Detection In Off State

**OFF State Open Load Detection**

Off State Open Load Detection requires an external pull-up resistor ( $R_{pull-up}$ ) connected between  $V_{OUT}$  pin and a positive supply voltage ( $V_{pull-up}$ ).

The external  $R_{pull-up}$  resistor value should be selected to ensure that a false OFF State OL condition is not detected when the load ( $R_L$ ) is connected. A  $V_{OUT}$  voltage above the  $V_{OL\_min}$  (Openload Off State Detection Threshold) minimum value with the load ( $R_L$ ) connected needs to be avoided. The following formula shows this relationship:

$$V_{OUT} = \left( V_{pull-up} / (R_L + R_{pull-up}) \right) R_L < V_{OL\_min}$$

In addition to ensuring the selected  $R_{pull-up}$  resistor value does not cause a false OFF State OL detection condition

when the load is connected, the  $R_{pull-up}$  must also not cause the OFF State OL to miss detecting an OL condition when the load is disconnected. A  $V_{OUT}$  voltage below the  $V_{OL\_max}$  (Openload Off State Detection Threshold) maximum value with the load ( $R_L$ ) disconnected needs to be avoided. The following formula shows this relationship:

$$R_{pull-up} < (V_{pull-up} - V_{OL\_max}) / OL_1$$

$$OL_1 = I_L (\text{Output Leakage with } V_{OUT} = 3.5 \text{ V})$$

Because  $I_d$  (OFF) may significantly increase if  $V_{OUT}$  is pulled high (up to several mA),  $R_{pull-up}$  resistor should be connected to a supply that is switched OFF when the module is in standby.

# NCV8460A

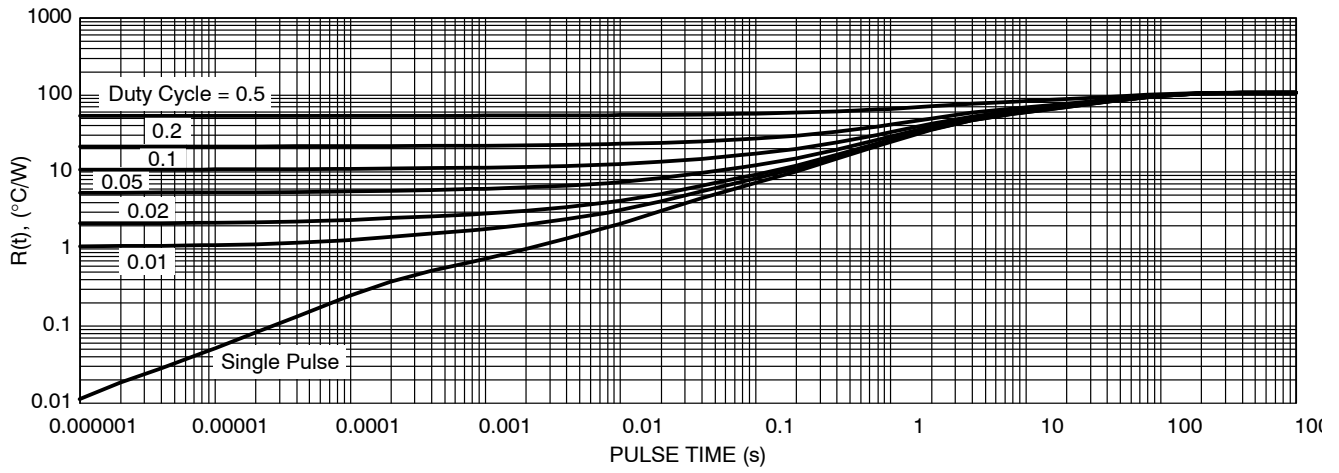

**Figure 33. Transient Thermal Impedance**

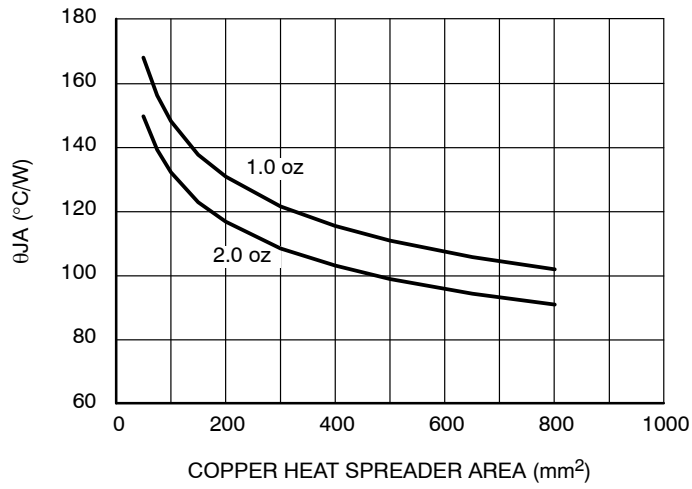
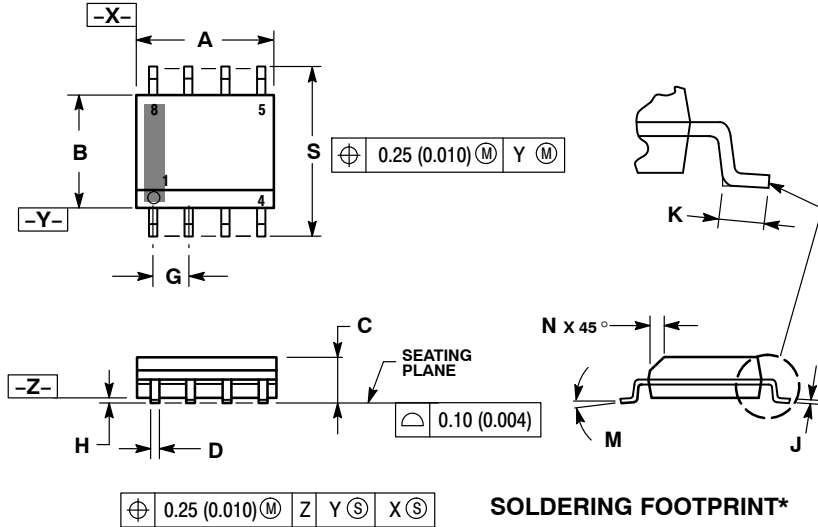

**Figure 34.  $R_{\theta_{JA}}$  vs Copper Area**

# NCV8460A

## PACKAGE DIMENSIONS

SOIC-8 NB  
CASE 751-07  
ISSUE AK



### NOTES:

1. DIMENSIONING AND TOLERANCING PER ANSI Y14.5M, 1982.
2. CONTROLLING DIMENSION: MILLIMETER.
3. DIMENSION A AND B DO NOT INCLUDE MOLD PROTRUSION.
4. MAXIMUM MOLD PROTRUSION 0.15 (0.006) PER SIDE.
5. DIMENSION D DOES NOT INCLUDE DAMBAR PROTRUSION. ALLOWABLE DAMBAR PROTRUSION SHALL BE 0.127 (0.005) TOTAL IN EXCESS OF THE D DIMENSION AT MAXIMUM MATERIAL CONDITION.
6. 751-01 THRU 751-06 ARE OBSOLETE. NEW STANDARD IS 751-07.

DIM	MILLIMETERS		INCHES	
	MIN	MAX	MIN	MAX
A	4.80	5.00	0.189	0.197
B	3.80	4.00	0.150	0.157
C	1.35	1.75	0.053	0.069
D	0.33	0.51	0.013	0.020
G	1.27 BSC		0.050 BSC	
H	0.10	0.25	0.004	0.010
J	0.19	0.25	0.007	0.010
K	0.40	1.27	0.016	0.050
M	0°	8°	0°	8°
N	0.25	0.50	0.010	0.020
S	5.80	6.20	0.228	0.244

### SOLDERING FOOTPRINT\*

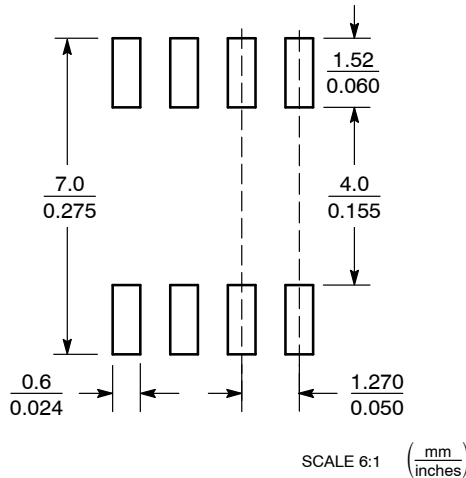

\*For additional information on our Pb-Free strategy and soldering details, please download the ON Semiconductor Soldering and Mounting Techniques Reference Manual, SOLDERRM/D.

ON Semiconductor and are registered trademarks of Semiconductor Components Industries, LLC (SCILLC). SCILLC owns the rights to a number of patents, trademarks, copyrights, trade secrets, and other intellectual property. A listing of SCILLC's product/patent coverage may be accessed at [www.onsemi.com/site/pdf/Patent-Marking.pdf](http://www.onsemi.com/site/pdf/Patent-Marking.pdf). SCILLC reserves the right to make changes without further notice to any products herein. SCILLC makes no warranty, representation or guarantee regarding the suitability of its products for any particular purpose, nor does SCILLC assume any liability arising out of the application or use of any product or circuit, and specifically disclaims any and all liability, including without limitation special, consequential or incidental damages. "Typical" parameters which may be provided in SCILLC data sheets and/or specifications can and do vary in different applications and actual performance may vary over time. All operating parameters, including "Typicals" must be validated for each customer application by customer's technical experts. SCILLC does not convey any license under its patent rights nor the rights of others. SCILLC products are not designed, intended, or authorized for use as components in systems intended for surgical implant into the body, or other applications intended to support or sustain life, or for any other application in which the failure of the SCILLC product could create a situation where personal injury or death may occur. Should Buyer purchase or use SCILLC products for any such unintended or unauthorized application, Buyer shall indemnify and hold SCILLC and its officers, employees, subsidiaries, affiliates, and distributors harmless against all claims, costs, damages, and expenses, and reasonable attorney fees arising out of, directly or indirectly, any claim of personal injury or death associated with such unintended or unauthorized use, even if such claim alleges that SCILLC was negligent regarding the design or manufacture of the part. SCILLC is an Equal Opportunity/Affirmative Action Employer. This literature is subject to all applicable copyright laws and is not for resale in any manner.

### PUBLICATION ORDERING INFORMATION

**LITERATURE FULFILLMENT:**  
Literature Distribution Center for ON Semiconductor  
P.O. Box 5163, Denver, Colorado 80217 USA  
**Phone:** 303-675-2175 or 800-344-3860 Toll Free USA/Canada  
**Fax:** 303-675-2176 or 800-344-3867 Toll Free USA/Canada  
**Email:** [orderlit@onsemi.com](mailto:orderlit@onsemi.com)

**N. American Technical Support:** 800-282-9855 Toll Free  
USA/Canada  
**Europe, Middle East and Africa Technical Support:**  
Phone: 421 33 790 2910  
**Japan Customer Focus Center**  
Phone: 81-3-5817-1050

**ON Semiconductor Website:** [www.onsemi.com](http://www.onsemi.com)  
**Order Literature:** <http://www.onsemi.com/orderlit>  
For additional information, please contact your local Sales Representative