

The RF Line

921 MHz - 960 MHz SiFET

RF Integrated Power Amplifier

The MHVIC910HR2 integrated circuit is designed for GSM base stations, uses Motorola's newest High Voltage (26 Volts) LDMOS IC technology, and contains a three-stage amplifier. Target applications include macrocell (driver function) and microcell base stations (final stage). The device is packaged in a PFP-16 Power Flat Pack package which gives excellent thermal performances through a solderable backside contact.

- Typical GSM Performance @ Full Frequency Band (921 - 960 MHz), 26 Volts
Output Power - 40 dBm (CW) @ P1dB
Power Gain - 39 dB @ P1dB
Efficiency - 48% @ P1dB
- Integrated ESD Protection
- Usable Frequency Range - 921 to 960 MHz
- Available in Tape and Reel. R2 Suffix = 1,500 Units per 16 mm, 13 inch Reel.

MHVIC910HR2

960 MHz, 10 W, 26 V
GSM CELLULAR
RF LDMOS INTEGRATED CIRCUIT

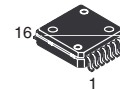

CASE 978-03
(PFP-16)

MAXIMUM RATINGS

Rating	Symbol	Value	Unit
Drain Supply Voltage	V_{DD}	28	Vdc
Gate Supply Voltage	V_{GS}	6	Vdc
RF Input Power	P_{in}	5	dBm
Case Operating Temperature	T_C	- 30 to + 85	°C
Storage Temperature Range	T_{stg}	- 65 to + 150	°C
Operating Channel Temperature	T_{ch}	150	°C

ESD PROTECTION CHARACTERISTICS

Test Conditions	Class
Human Body Model	0 (Minimum)
Machine Model	M2 (Minimum)

THERMAL CHARACTERISTICS

Characteristic	Symbol	Max	Unit
Thermal Resistance, Junction to Case	$R_{\theta JC}$	2.9	°C/W

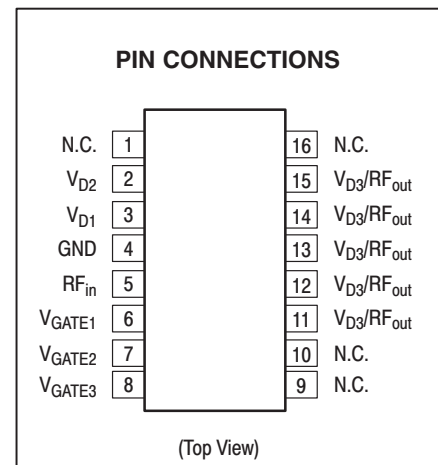
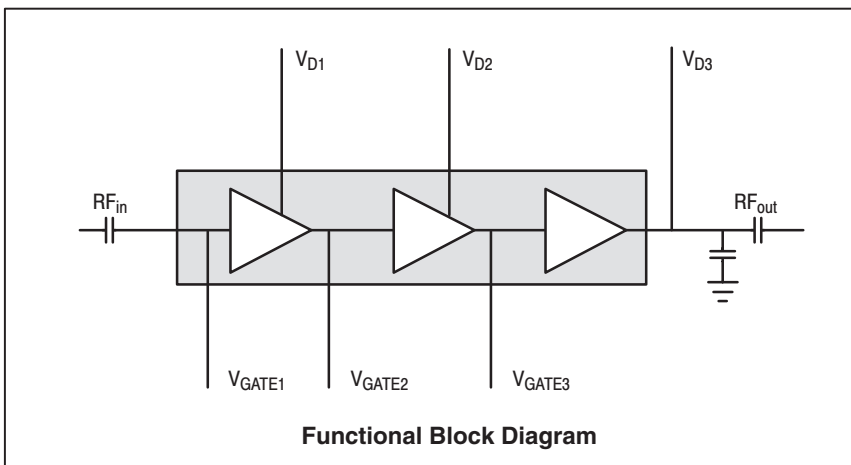

NOTE: MHVIC910HR2 Moisture Sensitivity Level (MSL) = 3.

RECOMMENDED OPERATING RANGES

Parameter	Symbol	Value	Unit
Drain Supply Voltage	V_{DD}	26	Vdc
3rd Stage Quiescent Current	I_{DQ3}	150	mA
2nd Stage Quiescent Current	I_{DQ2}	50	mA
1st Stage Quiescent Current	I_{DQ1}	25	mA

ELECTRICAL CHARACTERISTICS ($V_{DD} = 26$ V, V_{GS} set for $I_{DQ3} = 150$ mA, $T_A = 25^\circ\text{C}$ matched to a $50\ \Omega$ system, frequency range 921 – 960 MHz, unless otherwise noted)

Characteristic	Symbol	Min	Typ	Max	Unit
Frequency Range	f_{RF}	921	—	960	MHz
Output Power @ 1 dB Compression Point	P @ 1dB	39	40	—	dBm
Power Gain @ P1dB	G @ 1dB	38	39	—	dB
Power Added Efficiency @ 1 dB Compression Point	PAE @ 1dB	43	48	—	%
Input Return Loss @ P1dB	IRL @ 1dB	—	-15	-10	dB
Gain Flatness @ 40 dBm Variation ($T_C = -30$ to $+85^\circ\text{C}$ @ 40 dBm)	G_F G_V	— —	.5 5	— —	dB dB
Load Stability ($V_{DS} = 24$ V to 28 V, $P_{out} = \text{P1dB Down to } 0$ dBm, All Phase Angles)	VSWR	10:1	—	—	—
Ruggedness ($V_{DS} = 26$ V, $P_{out} = 42$ dBm, Load VSWR = 10:1, All Phase Angles)	Ψ	No Damage After Test			

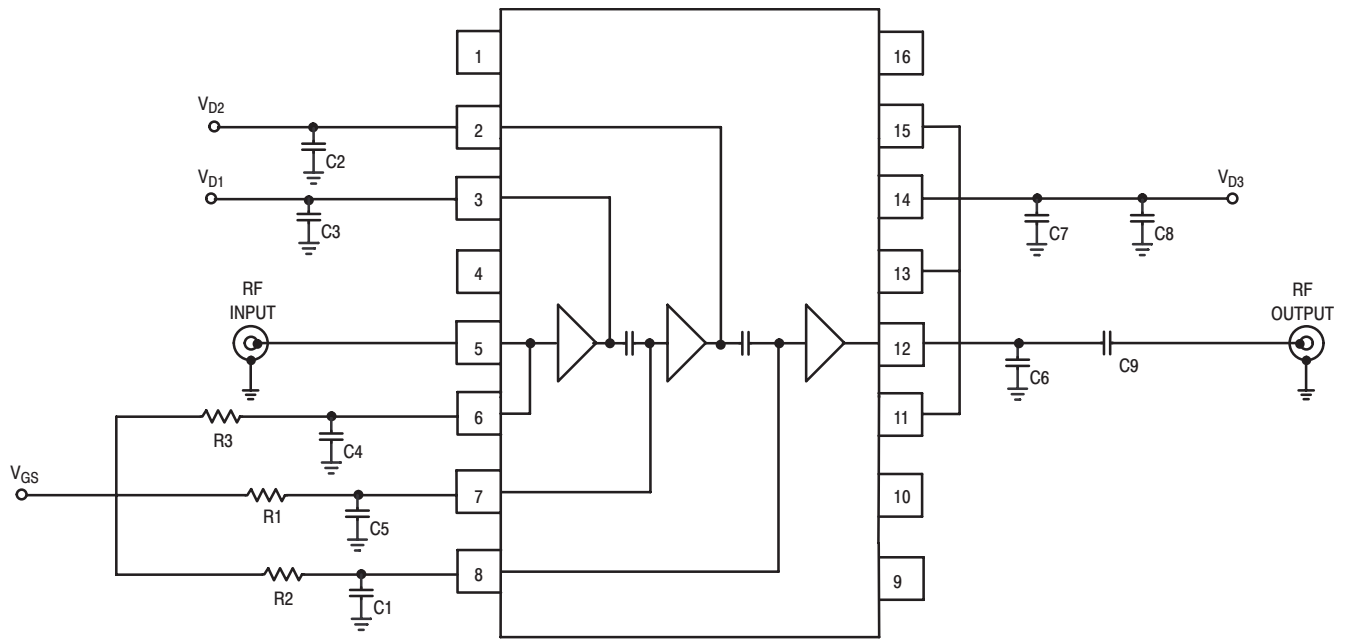

- | | | | |
|------------------------|--|------------|---------------------------------------|
| C1, C2, C3, C4, C5, C8 | 1 μ F Surface Mount Chip Capacitors | J1, J2 | Header (Break-away), HDR2X10STIMCSAFU |
| C6 | 4.7 pF AVX Chip Capacitor, ACCU-P (08051J4R7BBT) | J3, J4 | SMA Connector 2052-1618-02 (Threaded) |
| C7 | 47 pF AVX Chip Capacitor, ACCU-P (08055K470JBTR) | R1, R2, R3 | 100 Ω Chip Resistors (0402) |
| C9 | 33 pF AVX Chip Capacitor, ACCU-P (08053J330JBT) | PCB | Rogers 04350, 20 mils |

Figure 1. 921-960 MHz Demo Board Schematic

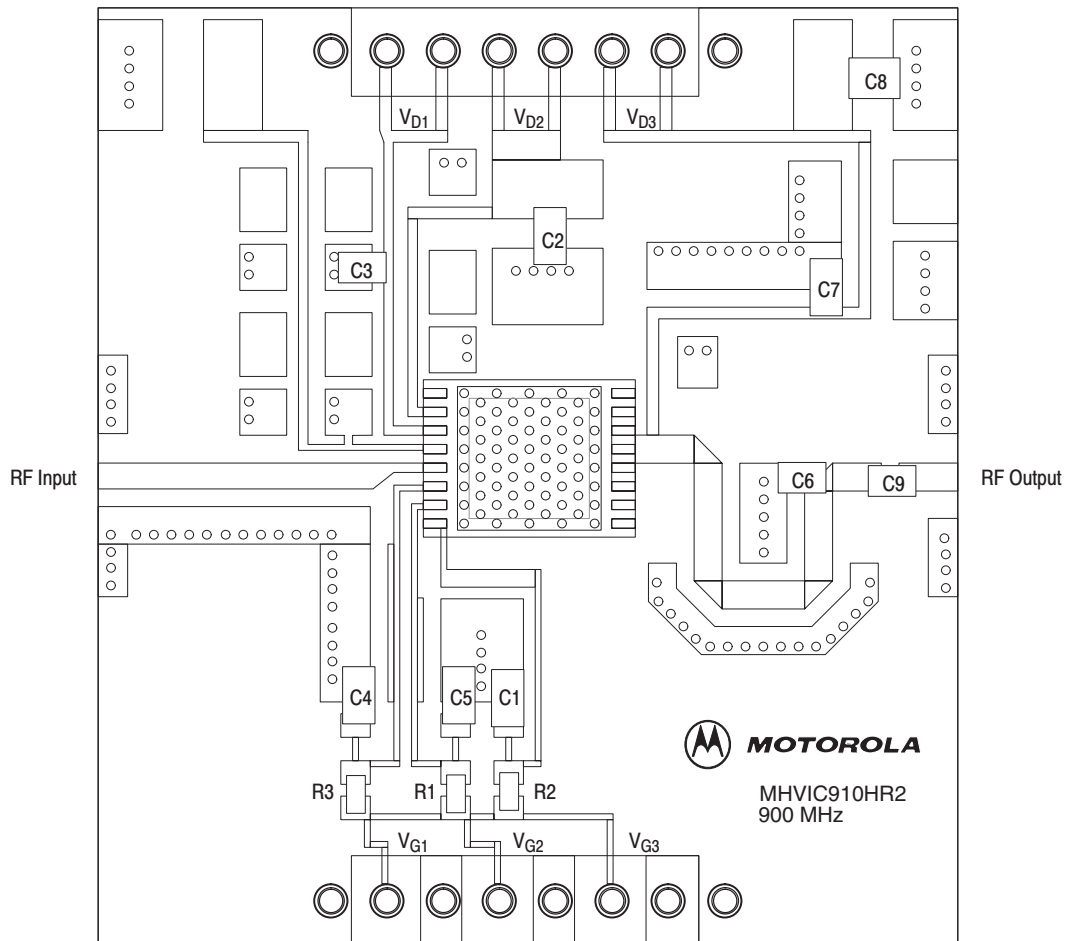

Figure 2. 921-960 MHz Demo Board Component Layout

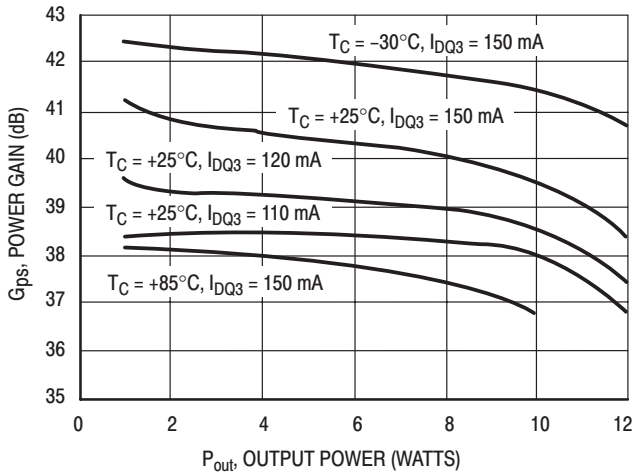

Figure 3. Power Gain versus Output Power

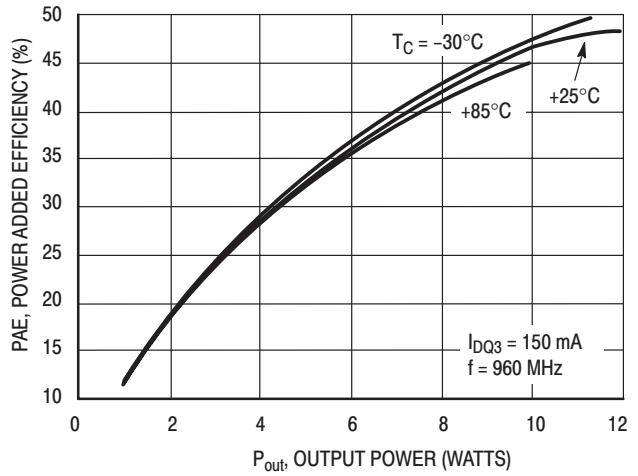

Figure 4. Power Added Efficiency versus Output Power

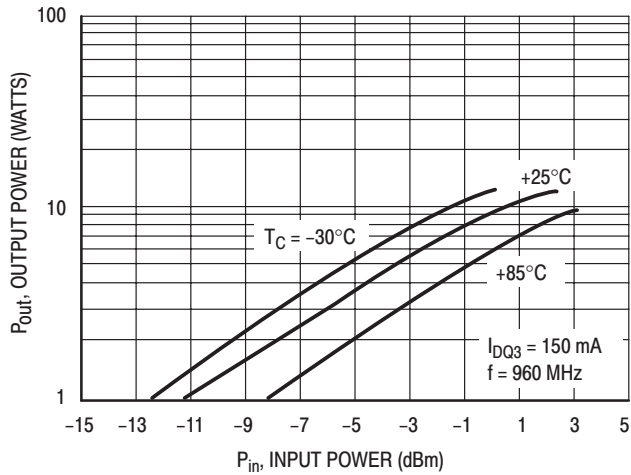

Figure 5. Output Power versus Input Power

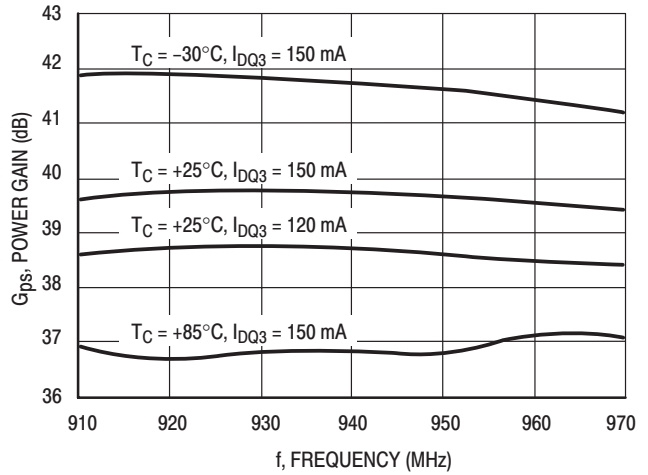

Figure 6. Power Gain versus Frequency
 $P_{out} = 10\text{ W}$

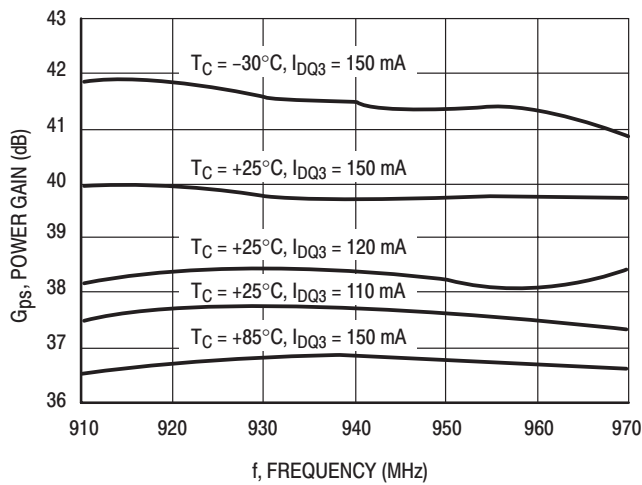

Figure 7. Power Gain versus Frequency
 $P_{out} = P1dB$

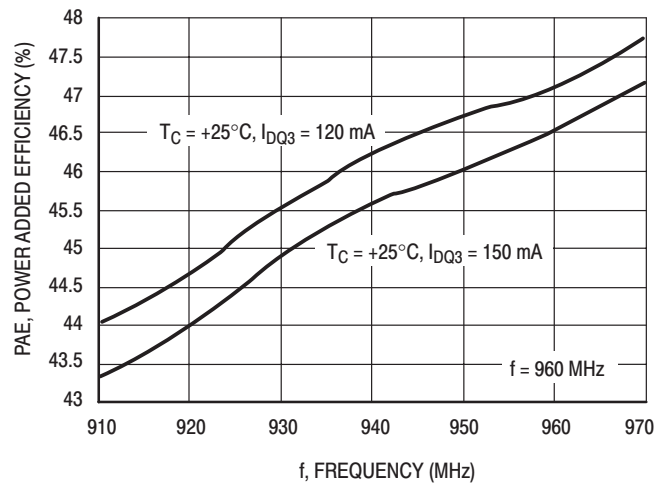

Figure 8. Power Added Efficiency versus Frequency
 $P_{out} = 10\text{ W}$

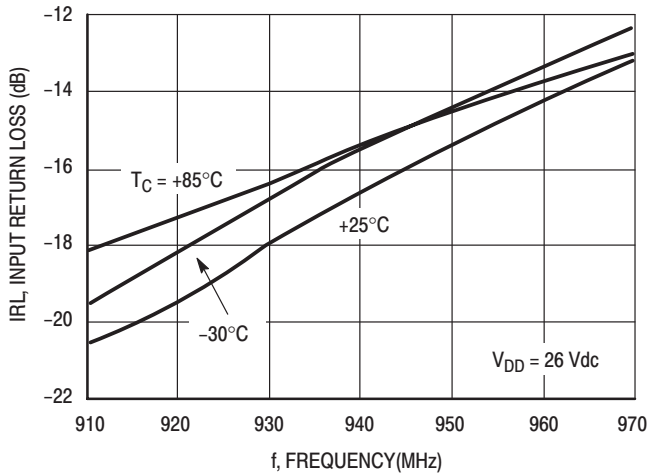

Figure 9. Input Return Loss versus Frequency
 $P_{out} = 10\text{ W}$

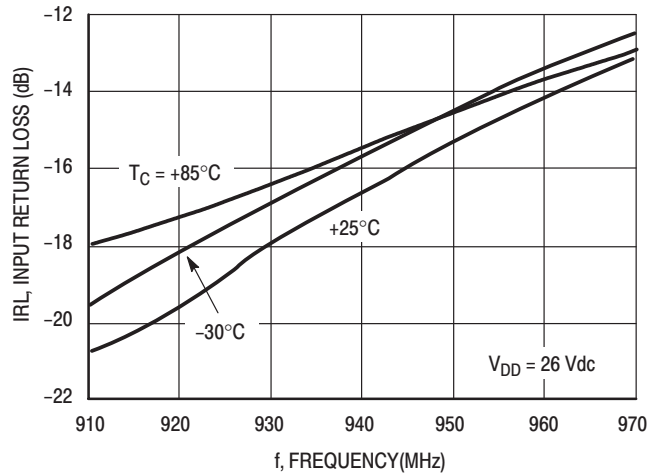

Figure 10. Input Return Loss versus Frequency
 $P_{out} = P1dB$

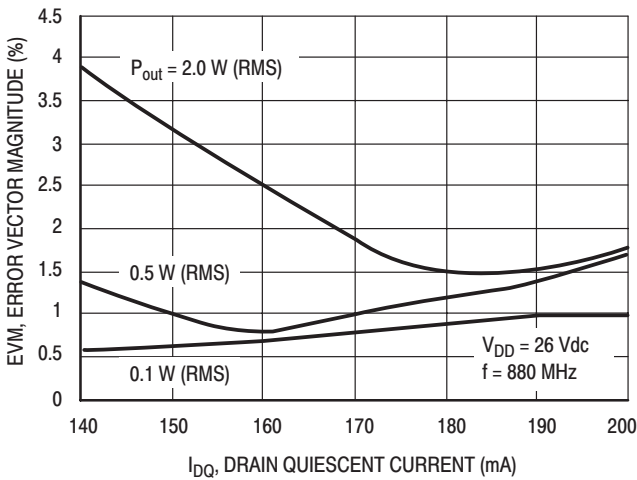

Figure 11. Error Vector Magnitude versus I_{DQ} Total

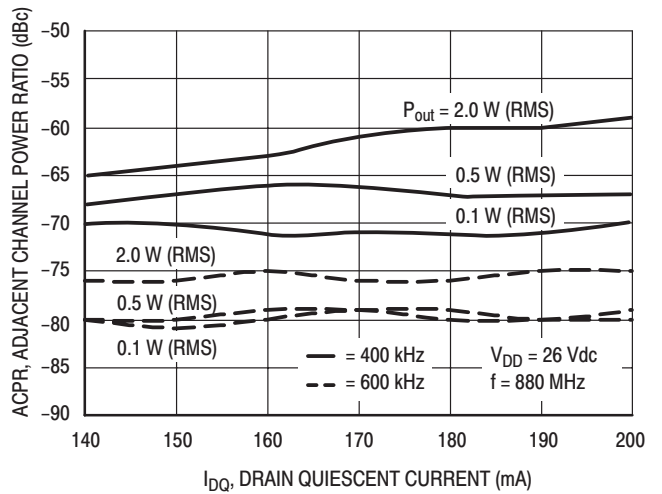

Figure 12. Adjacent Channel Power Ratio versus I_{DQ} Total

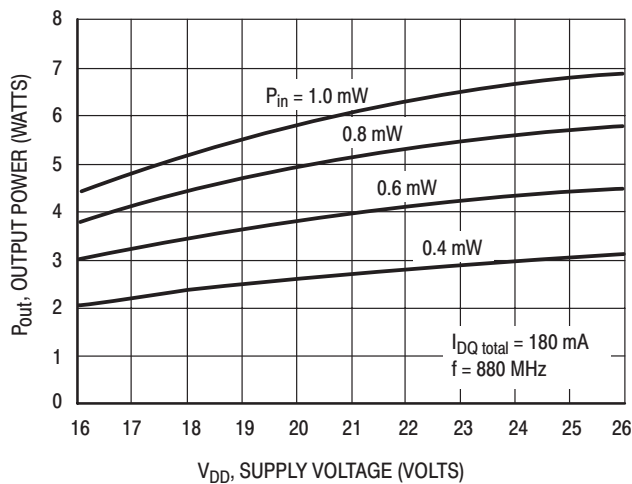

Figure 13. Output Power versus Supply Voltage

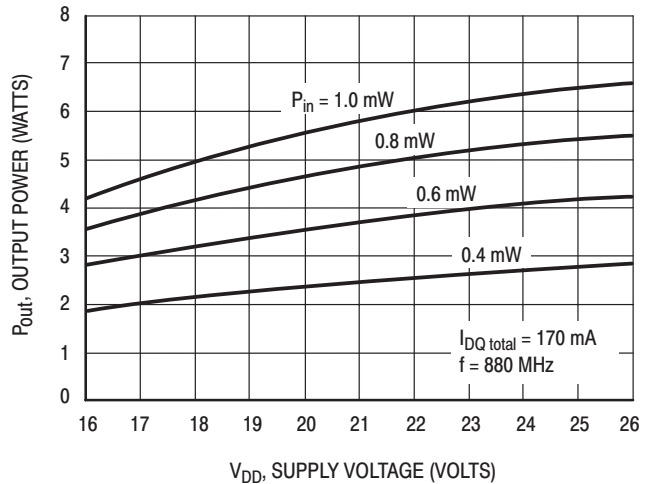

Figure 14. Output Power versus Supply Voltage

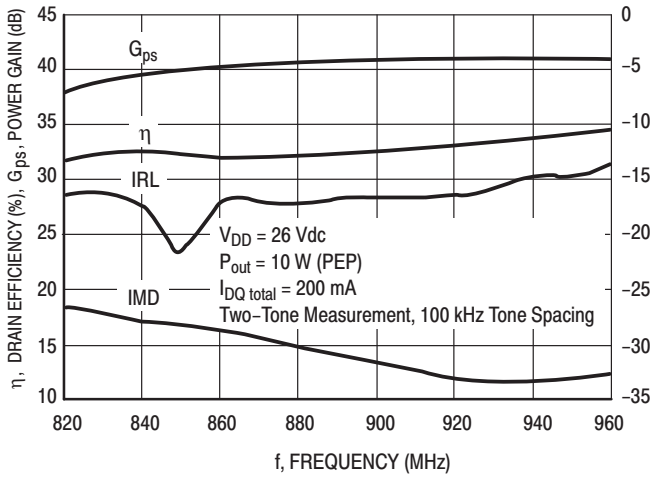

Figure 15. Two-Tone Broadband Performance

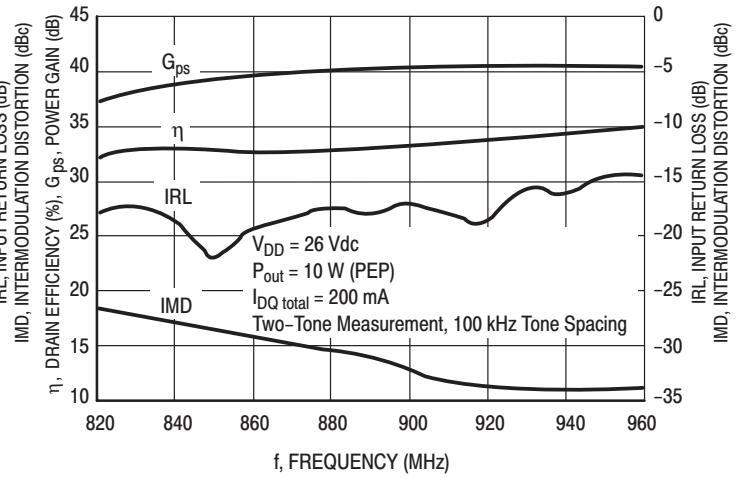

Figure 16. Two-Tone Broadband Performance

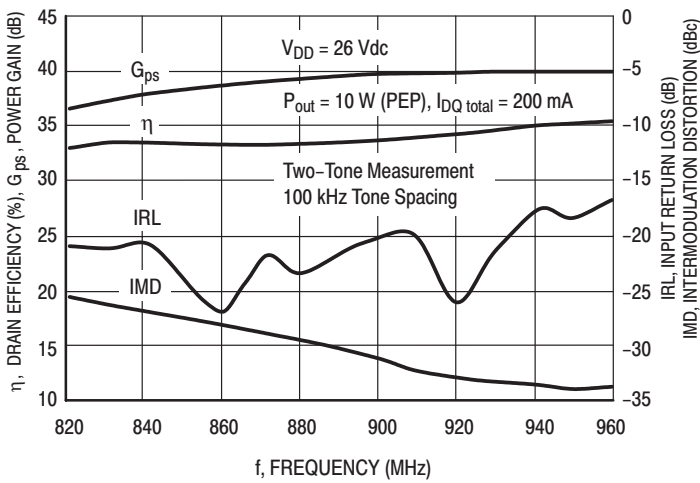

Figure 17. Two-Tone Broadband Performance

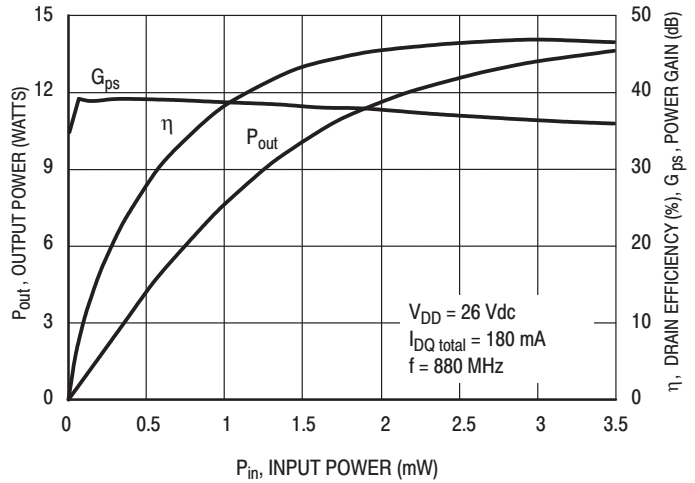

Figure 18. CW Performance @ 880 MHz

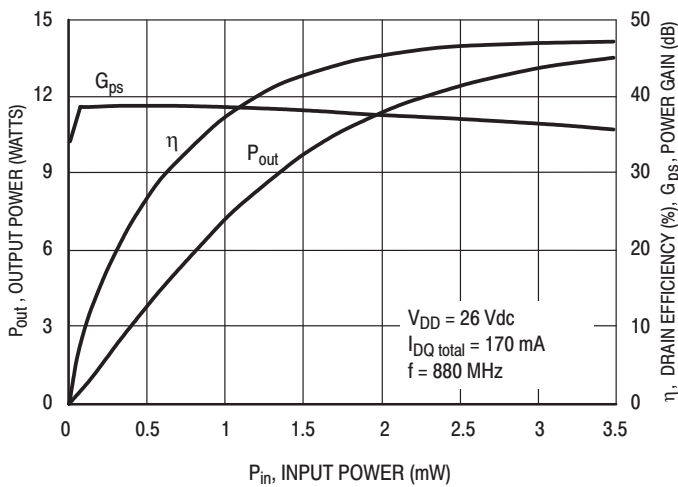

Figure 19. CW Performance @ 880 MHz

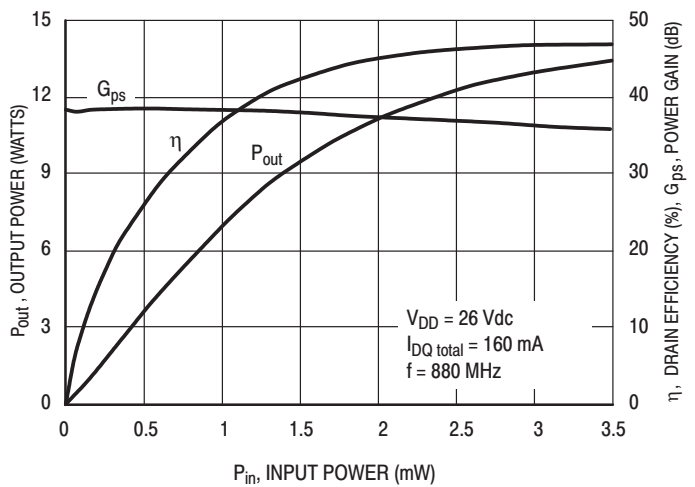

Figure 20. CW Performance @ 880 MHz

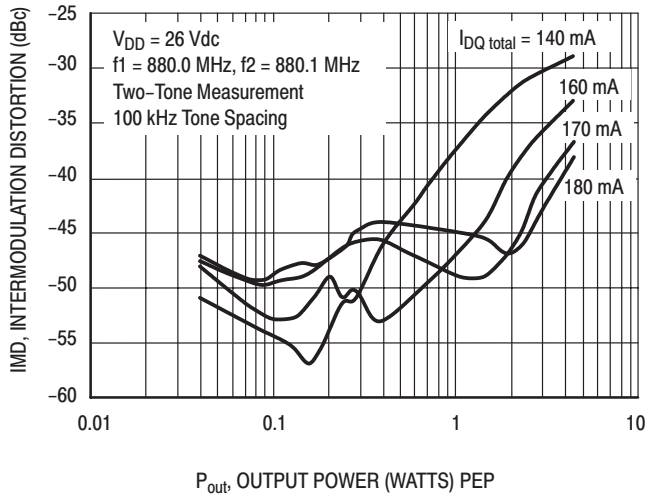
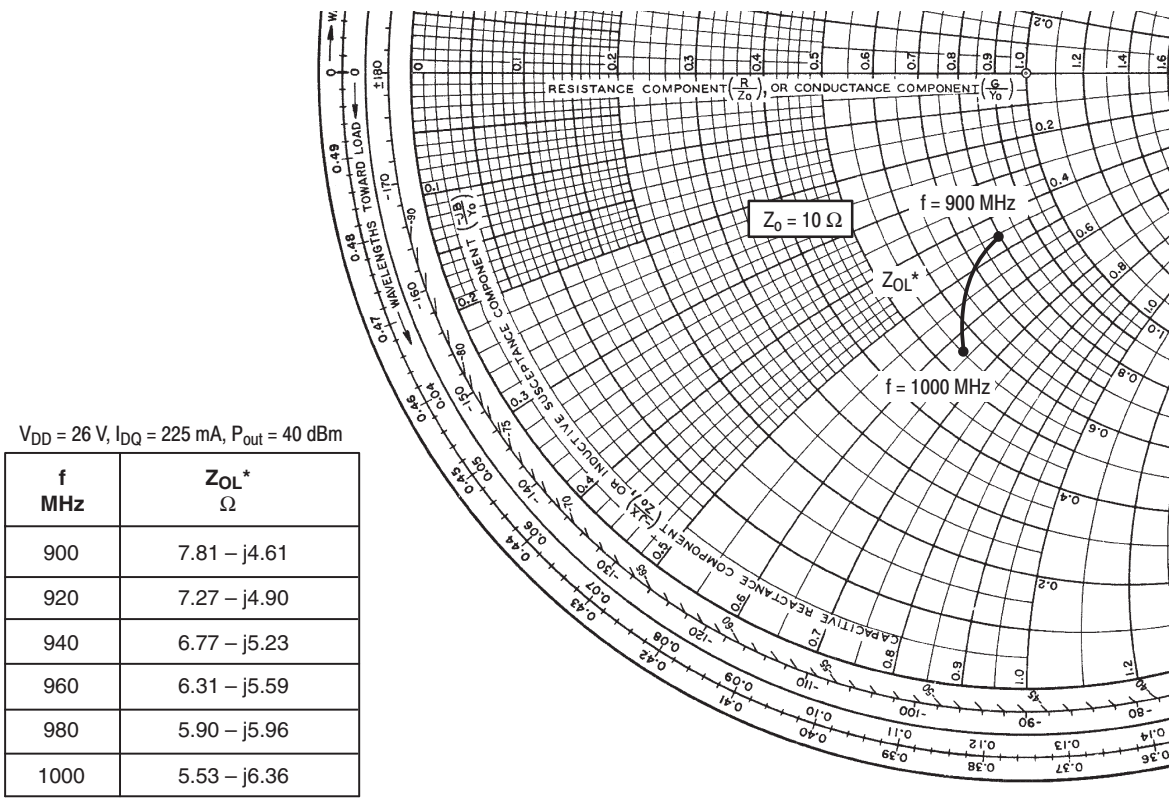

Figure 21. Intermodulation Distortion versus Output Power



Z_{OL}^* = Complex conjugate of the optimum load impedance at a given output power, voltage, IMD, bias current and frequency.

Note: Z_{OL}^* was chosen based on tradeoffs between gain, output power, and drain efficiency.

Figure 22. Large Signal Impedance

PACKAGE DIMENSIONS

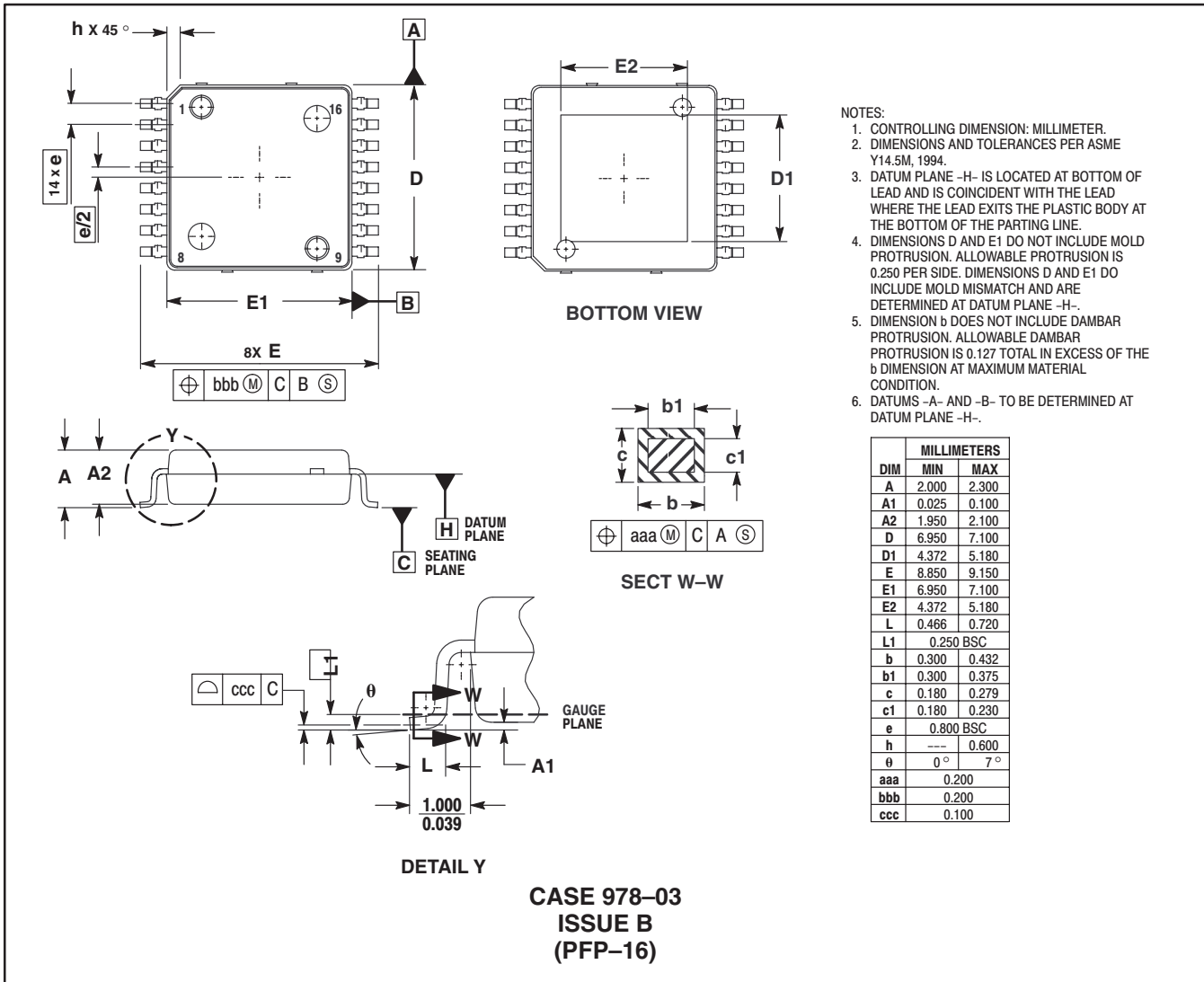

Motorola reserves the right to make changes without further notice to any products herein. Motorola makes no warranty, representation or guarantee regarding the suitability of its products for any particular purpose, nor does Motorola assume any liability arising out of the application or use of any product or circuit, and specifically disclaims any and all liability, including without limitation consequential or incidental damages. "Typical" parameters which may be provided in Motorola data sheets and/or specifications can and do vary in different applications and actual performance may vary over time. All operating parameters, including "Typicals" must be validated for each customer application by customer's technical experts. Motorola does not convey any license under its patent rights nor the rights of others. Motorola products are not designed, intended, or authorized for use as components in systems intended for surgical implant into the body, or other applications intended to support or sustain life, or for any other application in which the failure of the Motorola product could create a situation where personal injury or death may occur. Should Buyer purchase or use Motorola products for any such unintended or unauthorized application, Buyer shall indemnify and hold Motorola and its officers, employees, subsidiaries, affiliates, and distributors harmless against all claims, costs, damages, and expenses, and reasonable attorney fees arising out of, directly or indirectly, any claim of personal injury or death associated with such unintended or unauthorized use, even if such claim alleges that Motorola was negligent regarding the design or manufacture of the part. Motorola, Inc. Motorola, Inc. is an Equal Opportunity/Affirmative Action Employer. MOTOROLA and the logo are registered in the US Patent & Trademark Office. All other product or service names are the property of their respective owners.

© Motorola, Inc. 2002.

How to reach us:

USA/EUROPE/Locations Not Listed: Motorola Literature Distribution; P.O. Box 5405, Denver, Colorado 80217. 1-303-675-2140 or 1-800-441-2447

JAPAN: Motorola Japan Ltd.; SPS, Technical Information Center, 3-20-1, Minami-Azabu, Minato-ku, Tokyo 106-8573 Japan. 81-3-3440-3569

ASIA/PACIFIC: Motorola Semiconductors H.K. Ltd.; Silicon Harbour Centre, 2 Dai King Street, Tai Po Industrial Estate, Tai Po, N.T., Hong Kong. 852-26668334

Technical Information Center: 1-800-521-6274

HOME PAGE: <http://www.motorola.com/semiconductors/>

