

ASSP

Built-in IF Band Voltage Controlled Oscillator Mask ROM Frequency Synthesizer

MB15C703

DESCRIPTION

MB15C703 is a Phase Locked Loop (PLL) frequency synthesizer of pulse swallow operation with built-in VCO suitable for Intermediate Frequency band synthesizer of mobile phones.

The VCO can operate option oscillation frequency by an external inductance and capacitor. The PLL reference divide ratio and comparison divider ratio are fixed so that it is not required to set the divider ratios by a controller externally. BCC-20 plastic package miniaturized the device and makes it easier to design.

It operates with a supply voltage of 2.5 V typ. (PLLVD, VCOVDD) and low power consumption current 2.5mA typ. is realized by pure-CMOS.

FEATURES

- Pulse swallow function (counter type of MB15C103)
- Setting frequency

Setting frequency	Reference frequency
129.55 MHz	12.8 MHz

- Lock detector circuit: Digital lock detector circuit which is "H" level when PLL is locked.
- Low power supply voltage: 2.3 V to 2.7 V
- Low power supply current: 2.5 mA typ. (PLLVD = VCOVDD = 2.5 V, $f_{vco} = 129.55$ MHz)

(Continued)

PACKAGE

20-pad, plastic BCC

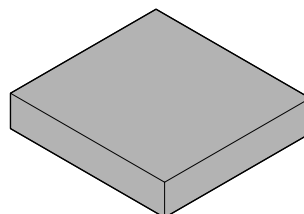

LCC-20P-M04

■ PIN DESCRIPTIONS

Pin No.	Symbol	I/O	Descriptions
1	VCOGND	—	Ground for the VCO.
2	N.C.	—	No connection.
3	VCOCNT	I	VCO control voltage input. Connection to PLLDo terminal via LPF.
4	VCOPS	I	Power saving control for the VCO. (Open is prohibited.) “H”: Normal mode “L”: Power saving mode
5	VCOVDD	—	Power supply voltage input for VCO. Connect to capacitor between GND.
6	LD	O	Lock detector signal output. LD = “H”: Locking mode or power saving mode LD = “L”: Unlocking mode.
7	N.C.	—	No connection.
8	OSCI _{in}	I	The reference counter input. Connect with a AC coupling capacitor.
9	f _{out}	O	Test purpose output. This pin is an open drain output.
10	PLLVDD	—	Power supply voltage input for the PLL. Connect to capacitor between GND.
11	N.C.	—	No connection.
12	N.C.	—	No connection.
13	PLLDo	O	PLL charge pump output. Connect to VCOCNT pin via LPF.
14	PLLGND	—	Ground for the PLL.
15	PLLfin	I	Prescaler input. Connect with an AC coupling capacitor.
16	PLLPS	I	Power saving control for the PLL. (Open is prohibited.) “H”: Normal mode “L”: Power saving mode
17	N.C.	—	No connection.
18	VCO _{out}	O	VCO output.
19	VCOTNKI	I	VCO tank circuit input. Connect to VCOTNKO pin with inductance-and-resistance. Connect to capacitor between GND.
20	VCOTNKO	O	VCO tank circuit output. Connect to capacitor VCOTNKI with inductance and resistance. Connect to capacitor between GND. (max.2.0 pF)

MB15C703

■ BLOCK DIAGRAM

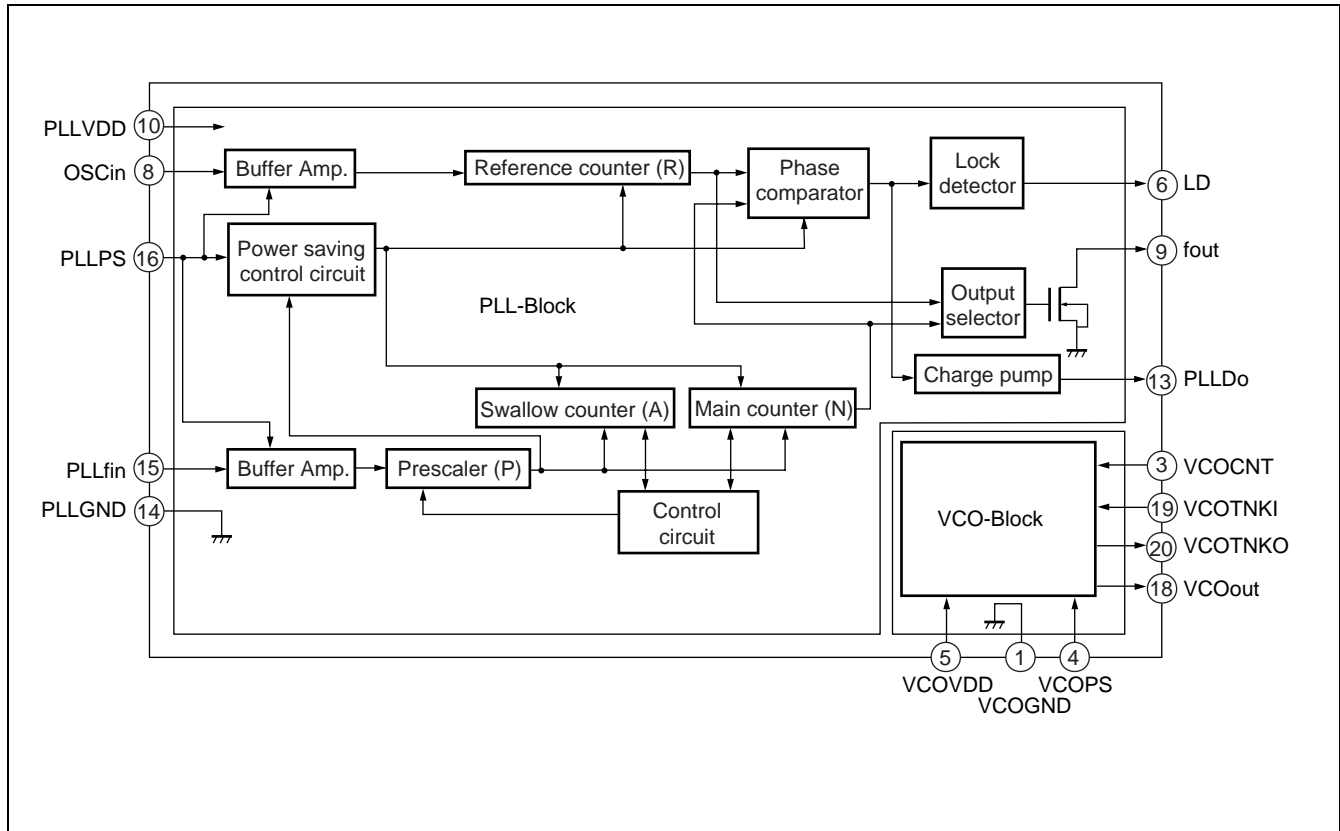

■ FUNCTIONAL DESCRIPTIONS

$$fvco = [(P \times N + A)] \times fosc / R$$

Symbol	Description	Setting value
fvco	Output frequency of voltage controlled oscillator	129.55 MHz
fosc	Reference oscillation frequency	12.80 MHz
N	Divide ratio of the main counter	161
A	Divide ratio of the swallow counter	15
P	Preset divide ratio of dual modulus the prescaler	16/17
R	Divide ratio of the reference counter	256 (fr = 50 kHz)

■ ABSOLUTE MAXIMUM RATINGS

Parameter	Symbol	Rating		Unit
		Min.	Max.	
Power supply voltage	V_{DD}	-0.5	4.0	V
Output voltage	V_O	-0.5	$V_{CC}+0.5$	V
Input voltage	V_i	-0.5	$V_{CC}+0.5$	V
Output current	I_o	0	+5.0	mA
Storage temperature	T_{stg}	-55	+125	°C

WARNING: Semiconductor devices can be permanently damaged by application of stress (voltage, current, temperature, etc.) in excess of absolute maximum ratings. Do not exceed these ratings.

■ RECOMMENDED OPERATING CONDITIONS

Parameter	Symbol		Value			Unit
			Min.	Typ.	Max.	
Power supply voltage	V_{DD}	PLLVD	2.3	2.5	2.7	V
		VCOVDD				
Input voltage	V_{IN}		GND	—	V_{DD}	V
Operating temperature	T_a		-20	—	+85	°C

WARNING: The recommended operating conditions are required in order to ensure the normal operation of the semiconductor device. All of the device's electrical characteristics are warranted when the device is operated within these ranges.

Always use semiconductor devices within their recommended operating condition ranges. Operation outside these ranges may adversely affect reliability and could result in device failure.

No warranty is made with respect to uses, operating conditions, or combinations not represented on the data sheet. Users considering application outside the listed conditions are advised to contact their FUJITSU representatives beforehand.

MB15C703

■ ELECTRICAL CHARACTERISTICS

(Recommended operating conditions unless otherwise noted.)

Parameter		Symbol	Condition	Value			Unit
				Min.	Typ.	Max.	
Power supply current	PLLVD	I_{PLL}	PLLVD = VCOVD = 2.5 V PLL-Lock (129.55 MHz)	—	2.5	4.0	mA
	VCOVD	I_{VCO}					
Power saving current	PLLVD	I_{PLLPS}	PLLPS = "L"	—	1	10	μ A
	VCOVD	I_{VCOPS}	VCOPS = "L"	—	—	1	μ A
Operating frequency	PLLfin	f_{in}	AC coupling by 1000 pF capacitor	100	129.55	400	MHz
	OSCin	f_{osc}	AC coupling by 1000 pF capacitor	3	12.8	26	MHz
Input sensitivity	OSCin	V_{osc}	AC coupling by 1000 pF capacitor	0.5	—	—	Vp-p
Input current	OSCin	I_{osc}	—	-100	—	+100	μ A
Output voltage	PLLDo	V_{OH}	$I_{OH} = -0.3$ mA	PLLVD - 0.8	—	—	V
		V_{OL}	$I_{OL} = 0.3$ mA	—	—	0.4	
Output current	PLLDo	I_{OH}	PLLVD = 2.5 V $V_{OH} = 1.5$ V	—	-4.5	—	mA
		I_{OL}	PLLVD = 2.5 V $V_{OL} = 1.0$ V	—	4.5	—	
High impedance cut off current	PLLDo	I_{OFF}	$0\text{ V} \leq PLLV_{Do} \leq PLLVD$	—	—	3	nA

REFERENCE CHARACTERISTICS

(PLLVD = VCOVDD = 2.5 V, Ta = +25 °C)

Parameter	Symbol	Condition	Value			Unit
			Min.	Typ.	Max.	
VCO variable range*1	Δf	f_{vco1} (at VCOCNT = 0.8 V) – f_{vco2} (at VCOCNT = 1.8 V)	—	8	—	MHz
VCO output level*2	V_{VCO}	—	—	-12	—	dBm
SYN reference leakage	Lef1	$\Delta \pm fr$	—	-67	—	dBc
	Lef2	$\Delta \pm (fr \times 2)$	—	-72	—	
SYN output S/N	S/N	$\Delta 1$ kHz	—	-71	—	dBc
SYN output C/N (BW = 21 kHz)	C/N1	$\Delta \pm 50$ kHz	—	108	—	dBc/Hz
	C/N2	$\Delta \pm 100$ kHz	—	113	—	
Spurious	Lsp1	2 nd Harmonic (Δf_{vco})	—	-3	—	dBc
	Lsp2	3 rd Harmonic ($\Delta (f_{vco} \times 2)$)	—	-10	—	
	Lsp3	4 th Harmonic ($\Delta (f_{vco} \times 3)$)	—	-20	—	
	Lsp4	Other ($\Delta (f_{vco} \times 4)$)	—	-25	—	
	Lsp5	TRX band ($\Delta (f_{vco} \times 5)$)	—	-30	—	
	Lsp6	TRX band ($\Delta (f_{vco} \times 6)$)	—	-35	—	
	Lsp7	—	—	-45	—	
	Lsp8	—	—	-50	—	
	Lsp9	—	—	-50	—	
	Lsp10	—	—	-55	—	
Lock-up time	T_{LOCK}	PLLPS “L” to “H” f_{vco} within ± 300 Hz, $V_{VCOout} = -12 \pm 3$ dBm	—	0.7	—	ms
VCO operating control voltage range	ΔV_{CNT}	—	0.5	—	VCOVDD -0.2	V
VCOCNT voltage*3	V_{CNT}	$f_o = 129.5$ MHz/PLL Lock	—	1.1	—	V

*1: An capacitor connected to VCOTNKO should be max. 2.0 pF.

*2: Insert resistor with 1 k Ω between VCOout terminal and GND.

*3: An external components is not included.

[Measurement circuit]

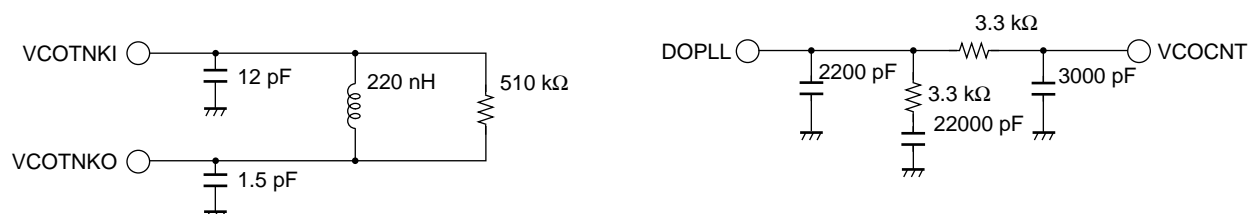

■ PHASE COMPARATOR OUTPUT WAVEFORM

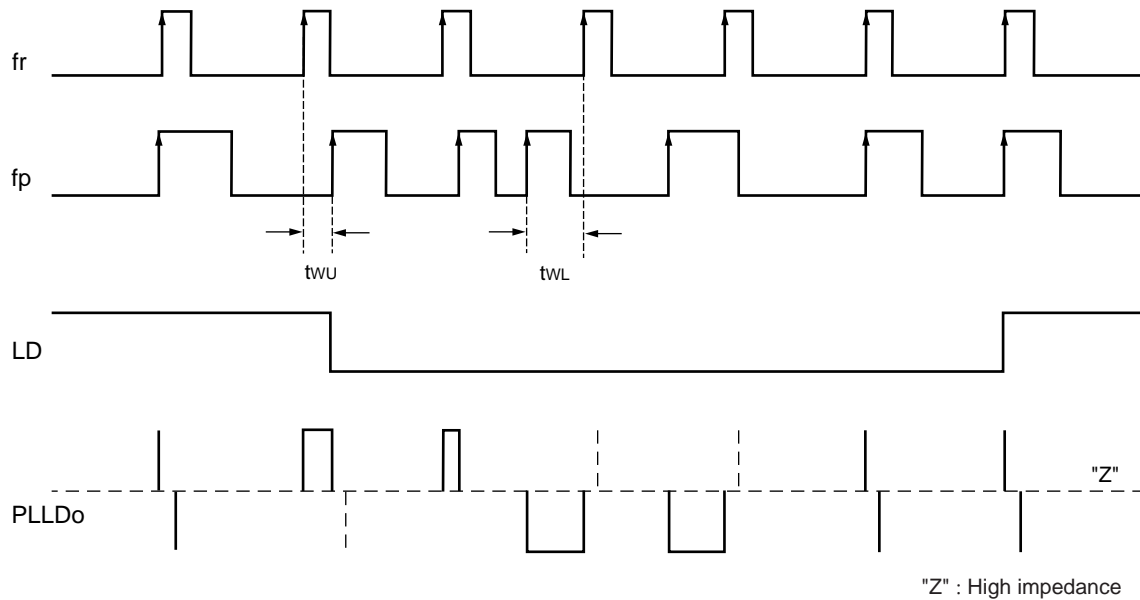

- Notes :
- Phase error detection range: -2π to $+2\pi$
 - Spikes on Do pulse during locking state are output to prevent dead zone
 - LD output becomes low when phase error is t_{WU} or more.
 - LD output becomes high when phase error is t_{WL} or less and continues to be so for three cycles or more.
 - t_{WU} and t_{WL} depend on OSCin input frequency.

$t_{WU} \geq 8/f_{osc}[s]$ (Ex.)	$f_{osc} = 12.8 \text{ MHz}$	$t_{WU} \geq 625.0 \text{ ns}$
$t_{WL} \leq 16/f_{osc}[s]$		$t_{WL} \leq 1250.0 \text{ ns}$

TYPICAL CHARACTERISTICS

1. fin input sensitivity

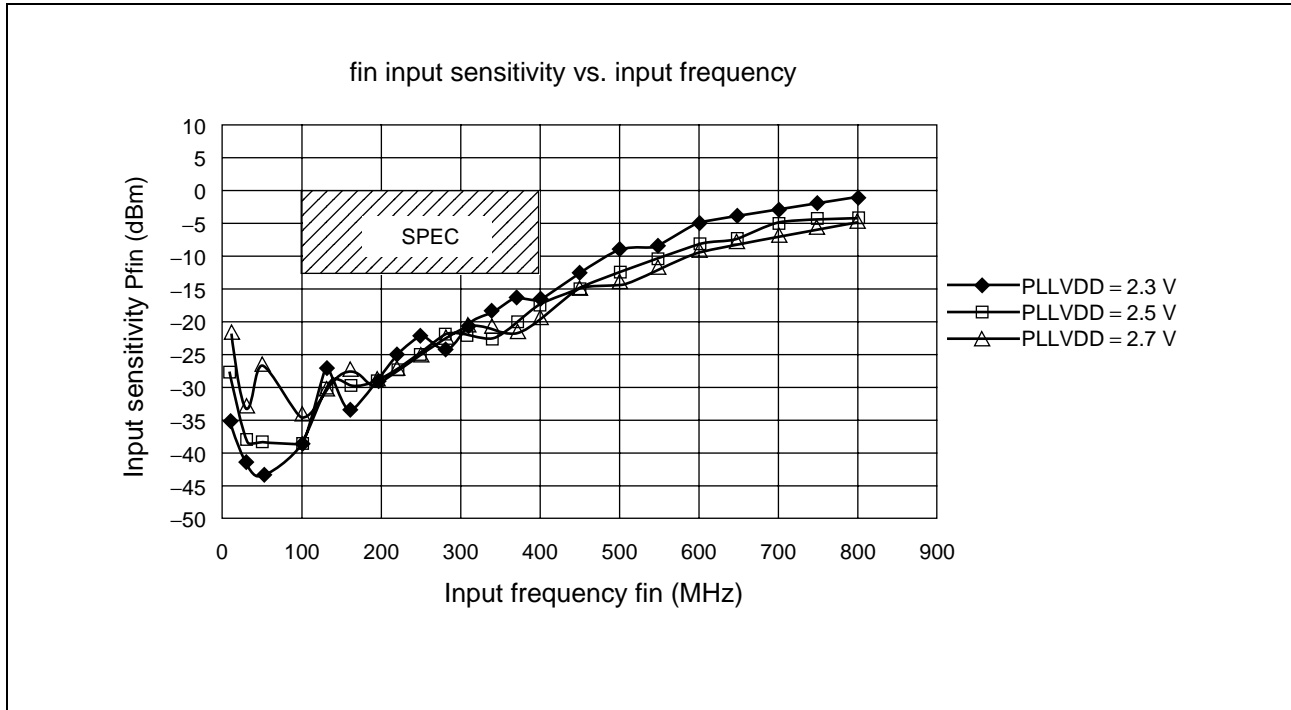

2. OSCin input sensitivity

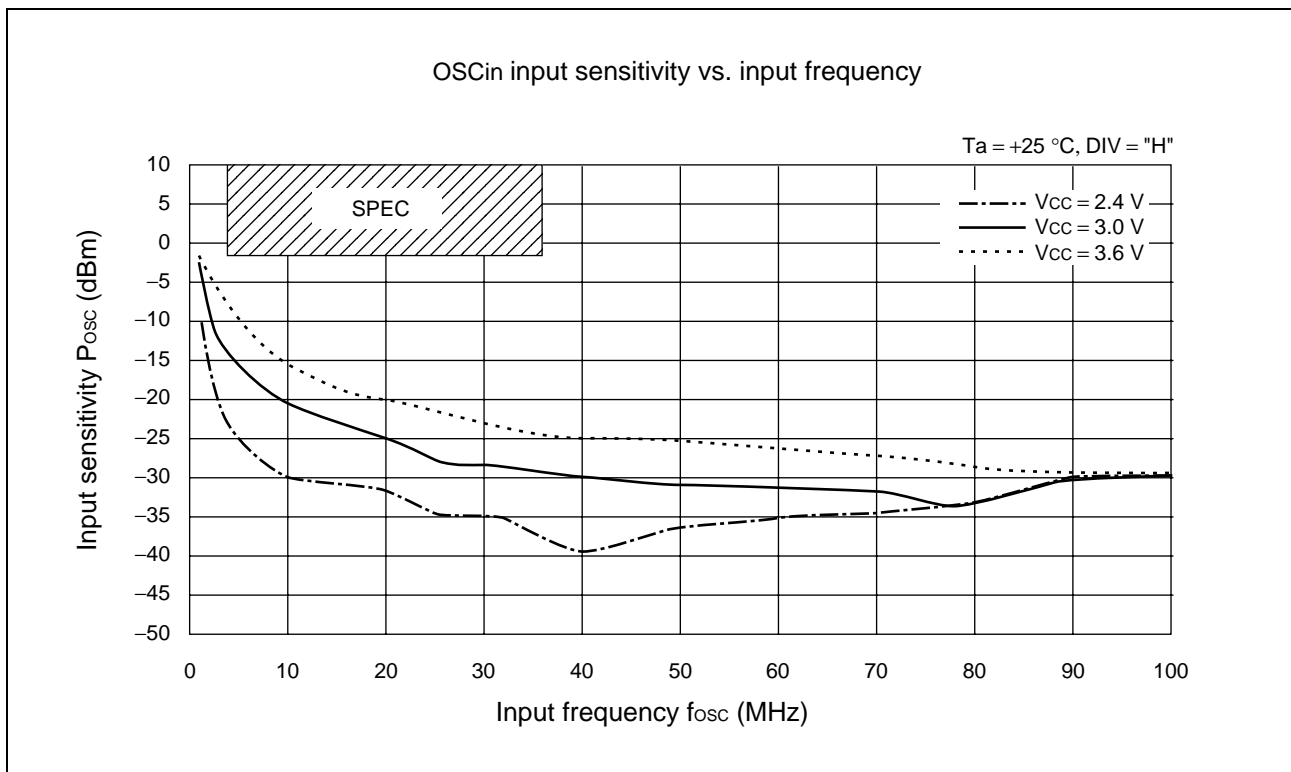

3. Do output current

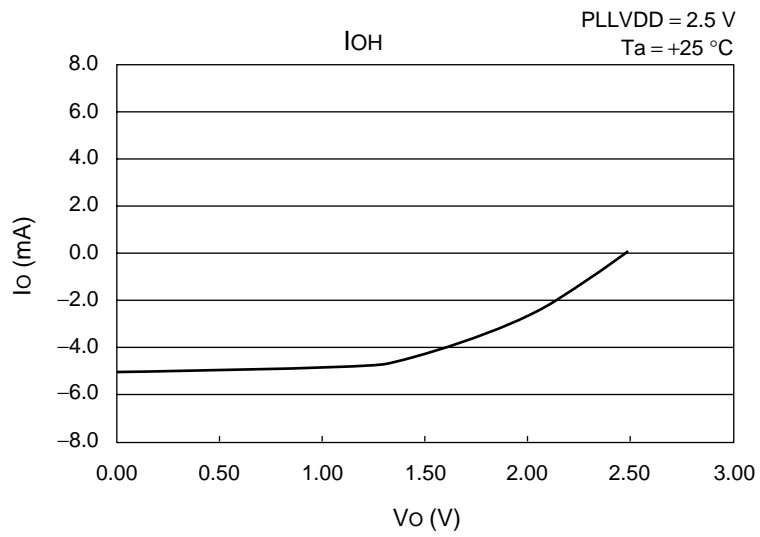
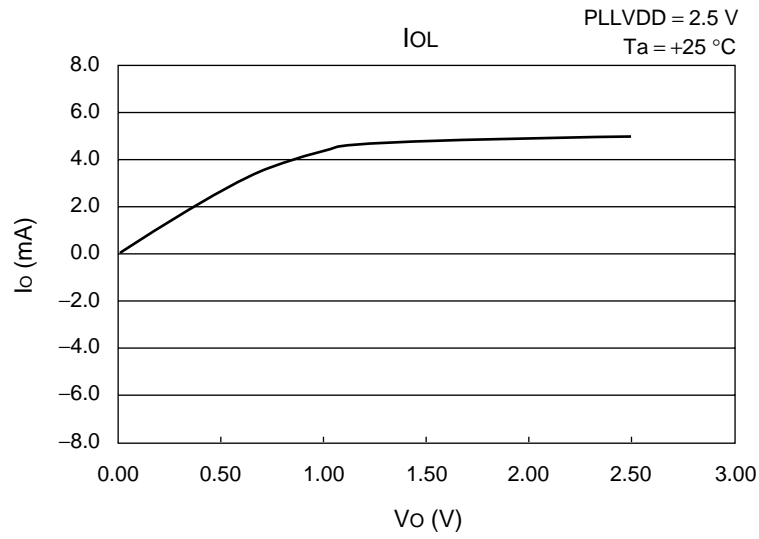

4. Characteristics Wave Form

- V_{COCNT} vs. f_{VCOout} Characteristics

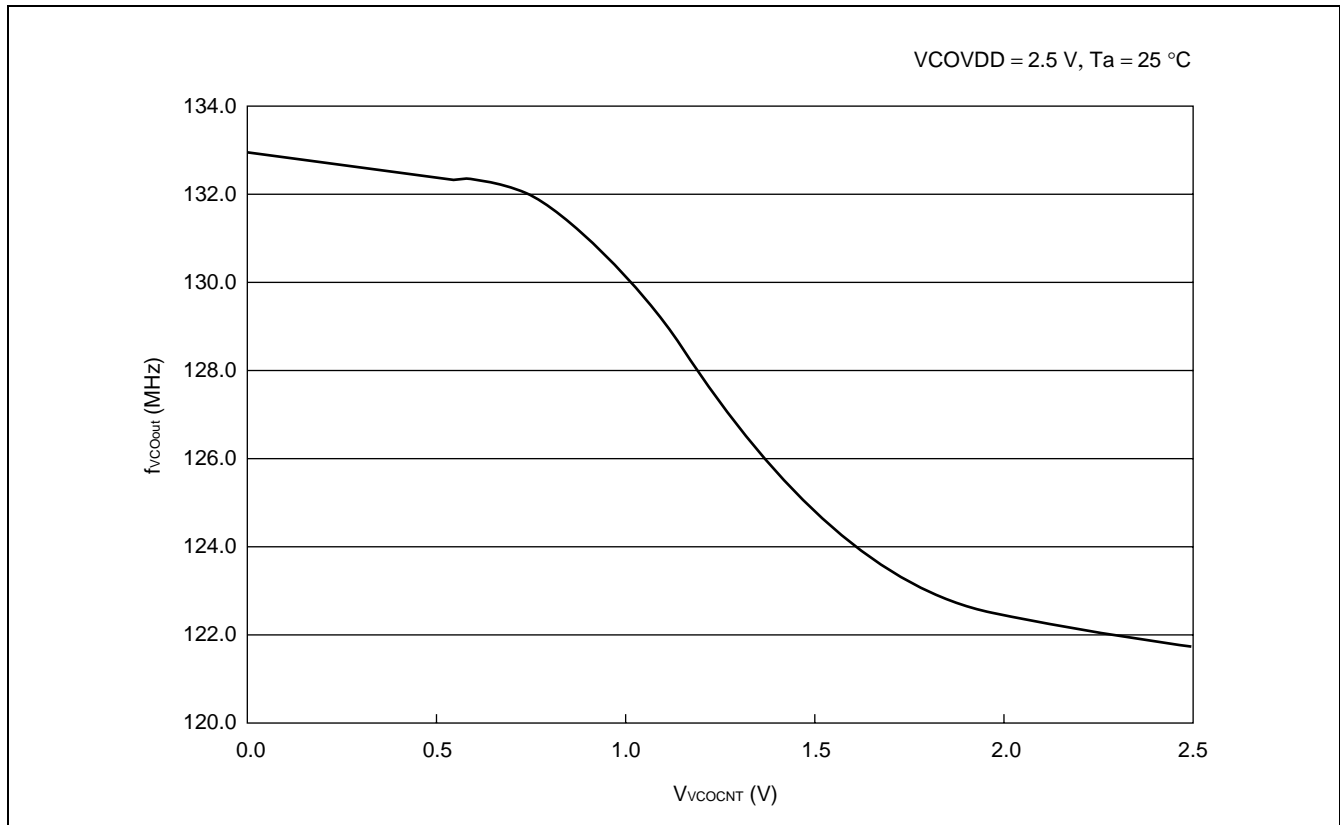

- Spectrum Wave Form (Reference Leakage)

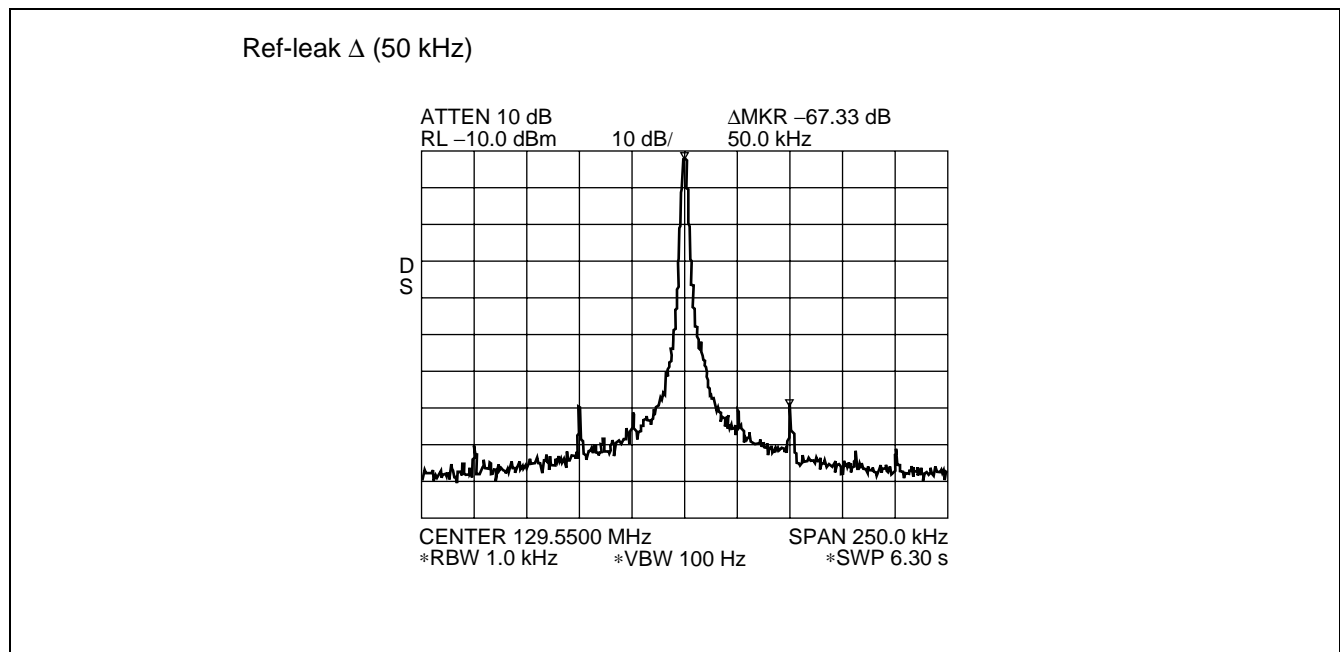

MB15C703

- SPECTRUM WAVE FROM (C/N , S/N , Sprious, Lock up time)

C/N Δ (50 kHz)

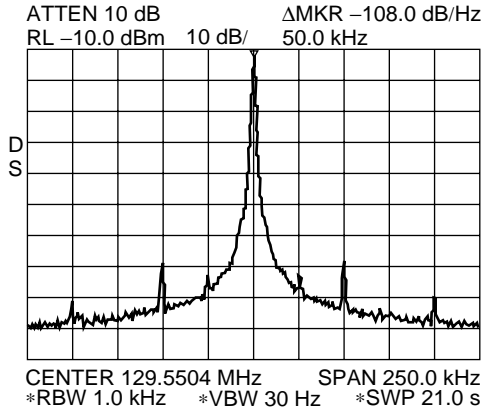

S/N Δ (1 kHz)

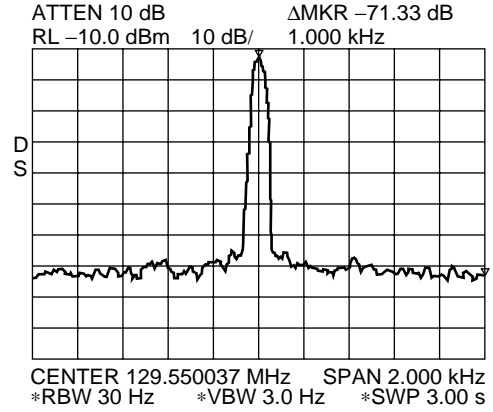

Sprious

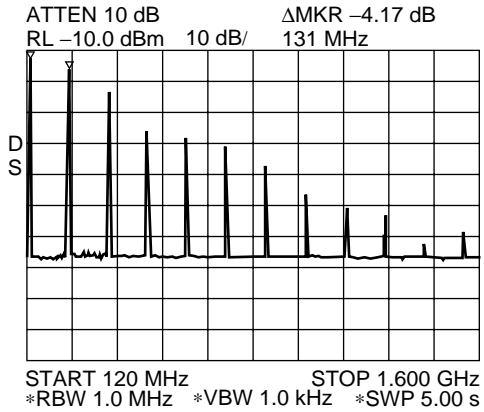

Lock up time (PLLPS mode to Lock, f_{vco} within ± 300 Hz)

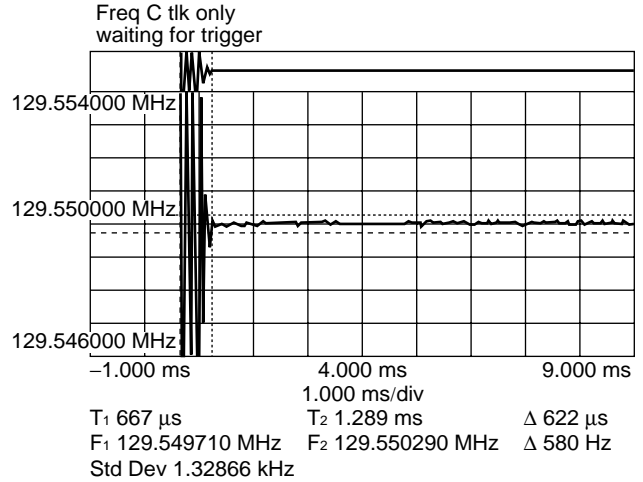

APPLICATION EXAMPLE

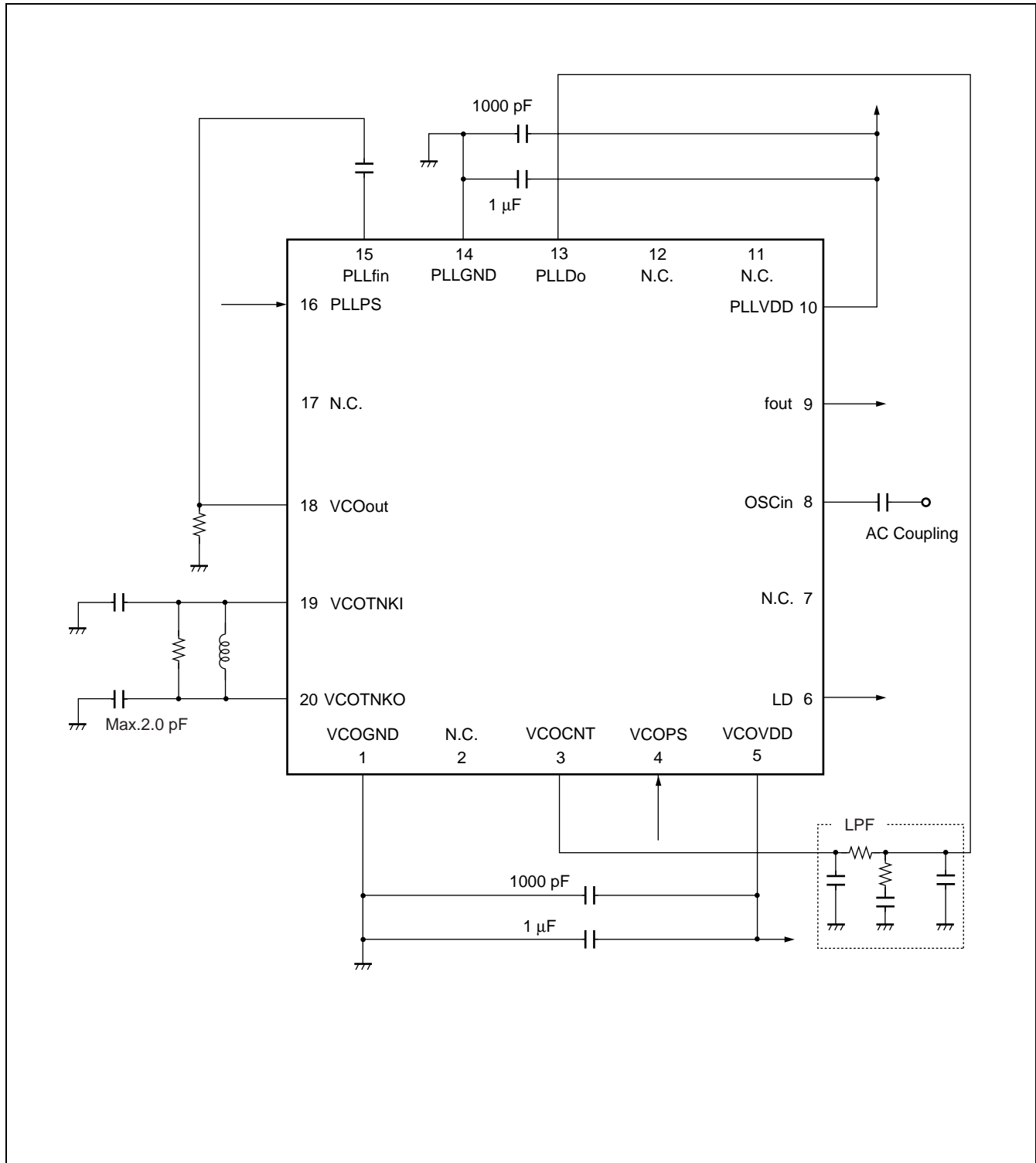

MB15C703

■ USAGE PRECAUTIONS

To protect against damage by electrostatic discharge, note the following handling precautions:

- Store and transport devices in conductive containers.
- Use properly grounded workstations, tools, and equipment.
- Turn off power before inserting device into or removing device from a socket.
- Protect leads with a conductive sheet when transporting a board-mounted device.

■ ORDERING INFORMATION

Part number	Package	Remarks
MB15C703	20-pad, plastic BCC (LCC-20P-M04)	

FUJITSU LIMITED

All Rights Reserved.

The contents of this document are subject to change without notice. Customers are advised to consult with FUJITSU sales representatives before ordering.

The information and circuit diagrams in this document are presented as examples of semiconductor device applications, and are not intended to be incorporated in devices for actual use. Also, FUJITSU is unable to assume responsibility for infringement of any patent rights or other rights of third parties arising from the use of this information or circuit diagrams.

The products described in this document are designed, developed and manufactured as contemplated for general use, including without limitation, ordinary industrial use, general office use, personal use, and household use, but are not designed, developed and manufactured as contemplated (1) for use accompanying fatal risks or dangers that, unless extremely high safety is secured, could have a serious effect to the public, and could lead directly to death, personal injury, severe physical damage or other loss (i.e., nuclear reaction control in nuclear facility, aircraft flight control, air traffic control, mass transport control, medical life support system, missile launch control in weapon system), or (2) for use requiring extremely high reliability (i.e., submersible repeater and artificial satellite).

Please note that Fujitsu will not be liable against you and/or any third party for any claims or damages arising in connection with above-mentioned uses of the products.

Any semiconductor devices have an inherent chance of failure. You must protect against injury, damage or loss from such failures by incorporating safety design measures into your facility and equipment such as redundancy, fire protection, and prevention of over-current levels and other abnormal operating conditions.

If any products described in this document represent goods or technologies subject to certain restrictions on export under the Foreign Exchange and Foreign Trade Law of Japan, the prior authorization by Japanese government will be required for export of those products from Japan.

F0007

© FUJITSU LIMITED Printed in Japan