

**SONY**

# CXP5056/CXP5058

## CMOS 4-bit 1 Chip Microcomputer

### Description

CXP5056/CXP5058 is a CMOS 4-bit microcomputer which consists of 4-bit CPU, ROM, RAM, I/O port, 8-bit timer, 8-bit timer/counter, 18-bit time base timer, 8-bit serial I/O, vector interruption, power on reset function, fluorescent display tube controller/driver, D/A conversion PWM output port, a remote control reception circuit, 3-bit A/D converters, a 32kHz timer/event counter and a power supply current detection reset function. They are integrated into a single chip with the standby function, etc. which are to be operated at a low power consumption.

### Features

- Instruction cycle 3.8  $\mu$ s/4.19MHz  
1.9  $\mu$ s/4.19MHz  
(High speed version)
- ROM capacity 8,192  $\times$  8 bits (CXP5058)  
6,144  $\times$  8 bits (CXP5056)
- RAM capacity 384  $\times$  4 bits (Including stack and display area)
- 43 general purpose I/O ports
- Fluorescent display tube controller/driver  
(Able to display maximum 256 segments)
  - 1 to 16 digits dynamic scan display
  - Page mode/variable mode
  - Dimmer function
  - High tension proof output (40V)
  - Selection possible for incorporating pull-down resistance (mask option)
- 14-bit PWM output for D/A conversion
- Remote control receiving circuit
- 3-bit A/D converter (8 channels per circuit)
- 32kHz timer/event counter
- 8-bit/4-bit variable serial I/O
- 8-bit timer, 8-bit timer/event counter and 18-bit time base timer, independently controlled
- Arithmetic and logical operations possible between the entire RAM area, I/O area and the accumulator by means of memory mapped I/O
- Reference to the entire ROM area is possible with the table look-up instruction
- 2 kinds of power down modes of sleep and stop
- Power on reset circuit (mask option)
- Provided with 80 pin plastic QFP
- Provided with 80 pin piggyback QFP (CXP5050)

### Structure

Silicon gate CMOS IC

### Package Outline

Unit : mm

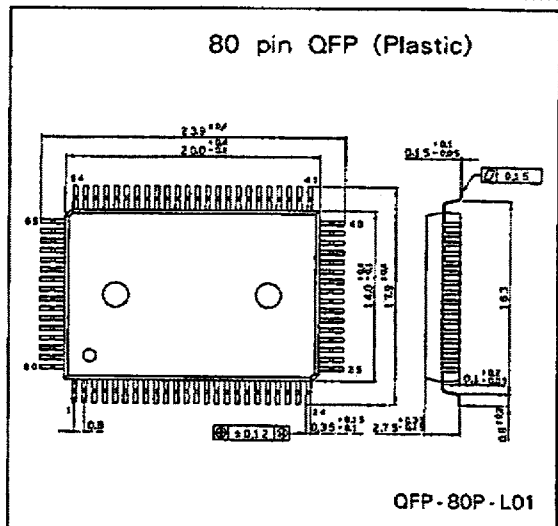

— 1 —  
SONY reserves the right to change products and specifications without notice.  
This information does not convey any license under patent rights of SONY corporation or others.

E89437 - ST

8382383 0017277 79T

Block Diagram

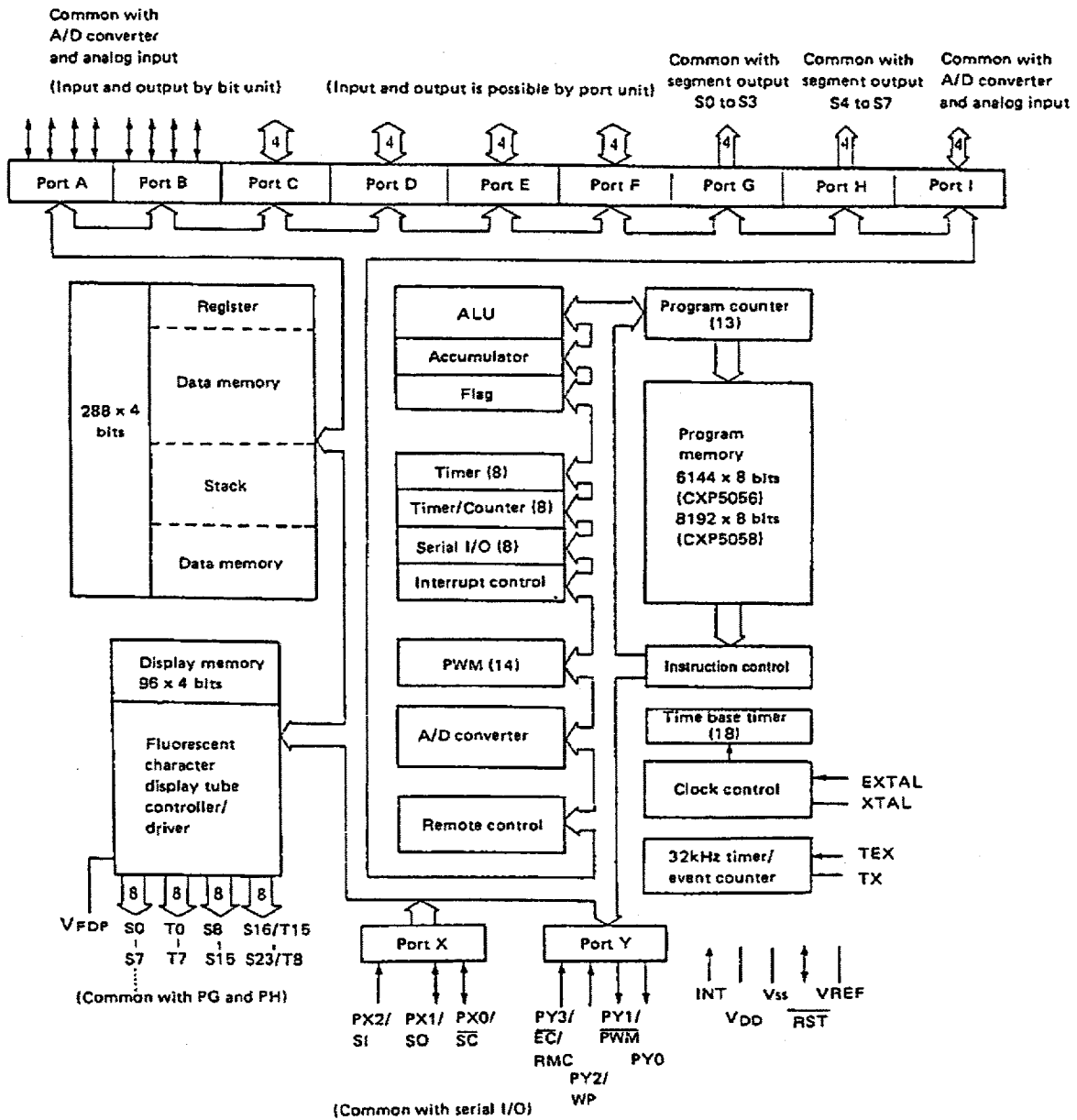

Pin Configuration Diagram (Top View)

Note) Do not make any connections to NC pins.

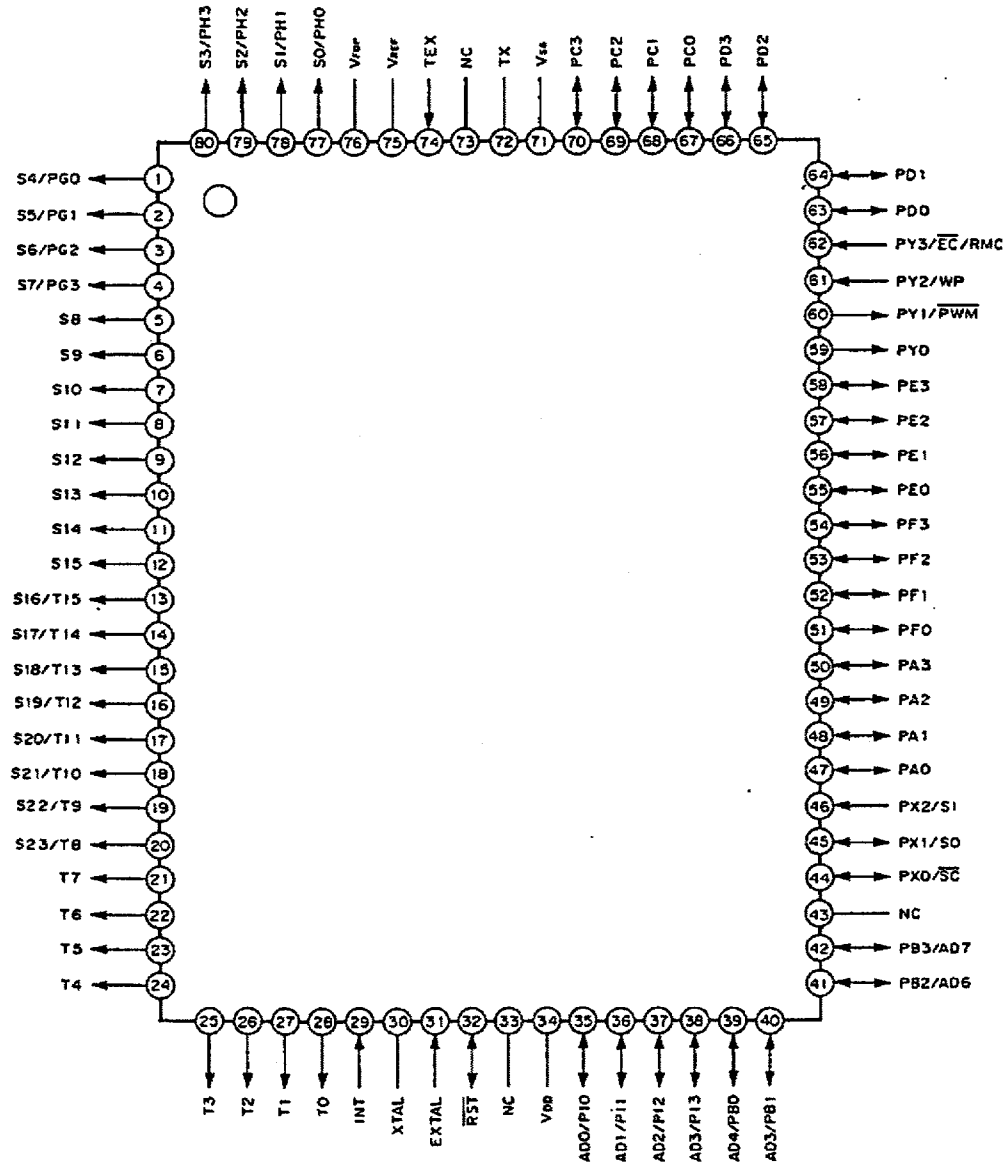

## Absolute Maximum Ratings

Ta = -20°C to +75°C, Vss = 0V

Item	Symbol	Rating	Unit	Remarks
Power supply voltage	V <sub>DD</sub>	-0.3 to +7.0	V	
Input voltage	V <sub>IN</sub>	-0.3 to +7.0* <sup>1</sup>	V	
Output voltage	V <sub>OUT</sub>	-0.3 to +7.0* <sup>1</sup>	V	
Display output voltage	V <sub>OD</sub>	V <sub>DD</sub> - 40 to V <sub>DD</sub> + 0.3	V	As P channel transistor is open drain, V <sub>OD</sub> voltage is determined as standard.
High level output current	I <sub>OH</sub>	-5	mA	Other than display output pins* <sup>2</sup> : per pin
	I <sub>ODH1</sub>	-15	mA	Display output S0 to S15: per pin
	I <sub>ODH2</sub>	-35	mA	Display output T0 to T7, T8/S23 to T15/S16: per pin
High level total output current	∑ I <sub>OH</sub>	-40	mA	Total of other than display output pins
	∑ I <sub>ODH</sub>	-100	mA	Total of display output pins
Low level output current	I <sub>OL</sub>	15	mA	Port 1 pin
	I <sub>OLC</sub>	20	mA	High current port pin* <sup>3</sup>
Low level total output current	∑ I <sub>OL</sub>	100	mA	Entire pin total
Operating temperature	T <sub>opr</sub>	-20 to +75	°C	
Storage temperature	T <sub>stg</sub>	-55 to +150	°C	
Allowable power dissipation	P <sub>D</sub>	600	mW	QFP

Note) Usage exceeding absolute maximum ratings may permanently impair the LSI. Normal operation should better take place under the recommended operation conditions. Exceeding those conditions may adversely affect the reliability of the LSI.

\*1) V<sub>IN</sub> and V<sub>OUT</sub> should not exceed V<sub>DD</sub> + 0.3V.

\*2) Specifies the output current of the general purpose I/O port PA to PF, PI, SO,  $\overline{SC}$ , PY0 and PY1.

\*3) The high current operation transistors are the N-CH transistors of the PC and PD ports.

## Recommended Operating Condition

Vss = 0V

Item	Symbol	Min.	Max.	Unit	Remarks
Power supply voltage	V <sub>DD</sub>	4.5	5.5	V	Guaranteed range during operation
		2.5	5.5	V	Guaranteed data hold operation range during STOP
High level input voltage	V <sub>IH</sub>	0.7V <sub>DD</sub>	V <sub>DD</sub>	V	
	V <sub>IHS</sub>	0.8V <sub>DD</sub>	V <sub>DD</sub>	V	Hysteresis input* <sup>1</sup>
	V <sub>IHEX</sub>	V <sub>DD</sub> - 0.4	V <sub>DD</sub> + 0.3	V	EXTAL pin* <sup>2</sup>
Low level input voltage	V <sub>IL</sub>	0	0.3V <sub>DD</sub>	V	
	V <sub>ILS</sub>	0	0.2V <sub>DD</sub>	V	Hysteresis input* <sup>1</sup>
	V <sub>ILEX</sub>	-0.3	0.4	V	EXTAL pin* <sup>2</sup>
Operating temperature	T <sub>opr</sub>	-20	+75	°C	

\*1) The TEX pin when the counter mode is selected by each of INT, PX0, PX2, PY2, PY3,  $\overline{RST}$  pins and mask option.

\*2) Specified only during external clock input.

Electrical Characteristics  
DC characteristics

Ta = -20°C to +75°C, Vss = 0V

Item	Symbol	Pin	Condition	Min.	Typ.	Max.	Unit
High level output voltage	V <sub>OH</sub>	PA to PF, PI PX0, PX1	V <sub>DD</sub> = 4.5V, I <sub>OH</sub> = -0.5mA	4.0			V
			V <sub>DD</sub> = 4.5V, I <sub>OH</sub> = -1.0mA	3.5			V
Low level output voltage	V <sub>OL</sub>	PY0, PY1 RST (V <sub>OL</sub> only)	V <sub>DD</sub> = 4.5V, I <sub>OL</sub> = 1.8mA			0.4	V
			V <sub>DD</sub> = 4.5V, I <sub>OL</sub> = 3.6mA			0.6	V
		PC, PD	V <sub>DD</sub> = 4.5V, I <sub>OL</sub> = 12mA			1.5	V
Input current	I <sub>IHE</sub>	EXTAL	V <sub>DD</sub> = 5.5V, V <sub>IH</sub> = 5.5V	0.5		40	μA
	I <sub>IIE</sub>		V <sub>DD</sub> = 5.5V, V <sub>IL</sub> = 0.4V	-0.5		-40	μA
	I <sub>IHT</sub>	TEX**3	V <sub>DD</sub> = 5.5V, V <sub>IH</sub> = 5.5V	0.1		10	μA
	I <sub>ILT</sub>		V <sub>DD</sub> = 5.5V, V <sub>IL</sub> = 0.4V	-0.1		-10	μA
	I <sub>ILR</sub>	RST **2	V <sub>DD</sub> = 5.5V, V <sub>IL</sub> = 0.4V	-1.5		-400	μA
High impedance I/O leakage current	I <sub>Iz</sub>	PA to PF, PI PX0 to PX2, PY2, PY3, INT, RST **2, TEX**3	V <sub>DD</sub> = 5.5V V <sub>I</sub> = 0, 5.5V			±10	μA
Display output current	I <sub>OH</sub>	S0 to S15	V <sub>DD</sub> = 4.5V	-7			mA
		S16/T15 to S23/T8, T0 to T7	V <sub>OH</sub> = V <sub>DD</sub> - 2.5V	-18			mA
Open drain output leakage current (P-CH Tr OFF in state)	I <sub>LOL</sub>	S0 to S15, S16/ T15 to S23/T8, T0 to T7	V <sub>DD</sub> = 5.5V V <sub>OL</sub> = V <sub>DD</sub> - 35V			-20	μA
Pull-down resistance**1	R <sub>L</sub>	S0 to S15, S16/ T15 to S23/T8, T0 to T7	V <sub>DD</sub> = 5V V <sub>FDP</sub> = V <sub>DD</sub> - 35V	60	100	270	kΩ
Supply current	I <sub>DD</sub>	V <sub>DD</sub>	Crystal oscillation (C1 = C2 = 22pF) of V <sub>DD</sub> = 5.5V, 4.19MHz entire output pins open		5 (7)**	15 (20)**	mA
	I <sub>DDSP</sub>		SLEEP mode		3 (5)**	9 (12)**	mA
	I <sub>DDS</sub>		STOP mode		30	200	μA
			V <sub>DD</sub> = 3V, 32kHz with T/C V <sub>DD</sub> = 5.5V, 32kHz without T/C (For mask option select counter, Pin is fixed.)				10
Input capacity	C <sub>IN</sub>	PA to PF, PI, PX, PY2, PY3, EXTAL, TEX, INT, RST	Clock 1MHz 0V other than the measured pins		10	20	pF

- \*1) In case the incorporated pull-down resistance has been selected with mask option.
- \*2)  $\overline{RST}$  pin specifies the input current when the pull-up resistance is selected, and specifies leakage current when nonresistance is selected.
- \*3) The TEX pin specifies the input current when the 32kHz oscillation is selected by the mask option, and specifies the leak current when the counter mode is specified.
- \*4) Specifies the power supply current of the high speed version.

**AC Characteristics**

(1) Clock timing

$T_a = -20^\circ\text{C}$  to  $+75^\circ\text{C}$ ,  $V_{DD} = 4.5\text{V}$  to  $5.5\text{V}$ ,  $V_{SS} = 0\text{V}$

Item	Symbol	Pin	Condition	Min.	Max.	Unit
System clock frequency	$f_c$	XTAL EXTAL	Fig. 1, Fig. 2	1	5	MHz
System clock input pulse width	$t_{XL}$ $t_{XH}$	EXTAL	Fig. 1, Fig. 2 (External clock drive)	90		ns
System clock input rising and falling times	$t_{CR}$ $t_{CF}$				200	ns
Event count clock input pulse width	$t_{EL}$ $t_{EH}$	$\overline{EC}$	Fig. 3	$t_{sys}^{*1}$ $+0.05$		$\mu\text{s}$
Event count clock input rising and falling times	$t_{ER}$ $t_{EF}$	$\overline{EC}$	Fig. 3		20	ms
Event count input clock input pulse width	$t_{TL}$ $t_{TH}$	TEX <sup>*2</sup>	Fig. 3	10		$\mu\text{s}$
Event count input clock rising and falling times	$t_{TR}$ $t_{TF}$	TEX <sup>*2</sup>	Fig. 3		20	ms

\*1)  $t_{sys}$  in the standard version is  $t_{sys} = 16/f_c$   
 $t_{sys}$  in the high speed version is  $t_{sys} = 8/f_c$

\*2) Specified when the counter mode is selected by the mask option.

Note) When adjusting the frequency accurately, there may be cases in which they may differ from Fig. 2.

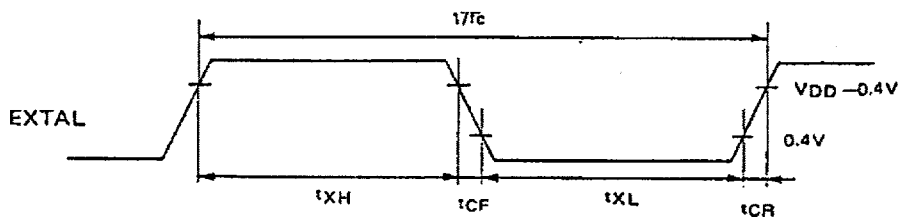

Fig. 1 Clock timing

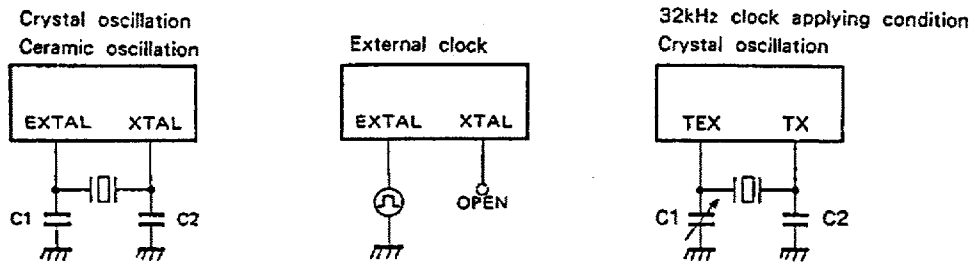

Fig. 2 Clock applying condition

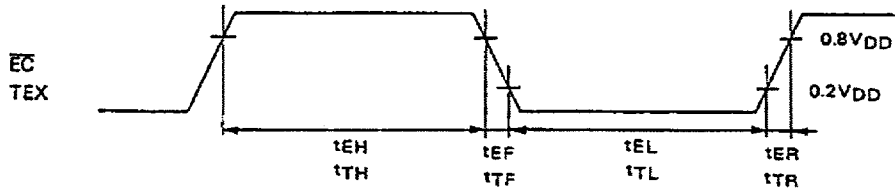

Fig. 3 Event count clock timing

(2) Serial transfer

Ta = -20°C to +75°C, VDD = 4.5V to 5.5V, VSS = 0V

Item	Symbol	Pin	Condition	Min.	Max.	Unit
Serial transfer clock ( $\overline{SC}$ ) cycle time	tkcy	$\overline{SC}$	Input mode	$t_{sys}/4 + 1.42$		$\mu s$
			Output mode	$2t_{sys}$		$\mu s$
Serial transfer clock ( $\overline{SC}$ ) high and low level widths	tkh tkl	$\overline{SC}$	Input mode	$t_{sys}/8 + 0.7$		$\mu s$
			Output mode	$t_{sys} - 0.1$		$\mu s$
Serial data input setup time (against $\overline{SC}$ ↑)	tsix	SI	$\overline{SC}$ input mode	0.1		$\mu s$
			$\overline{SC}$ output mode	0.2		$\mu s$
Serial data input hold time (against $\overline{SC}$ ↑)	tksl	SI	$\overline{SC}$ input mode	$t_{sys}/8 + 0.5$		$\mu s$
			$\overline{SC}$ output mode	0.1		$\mu s$
Data delay time from $\overline{SC}$ falling	tkso	SO			$t_{sys}/8 + 0.5$	$\mu s$

- Note 1)  $t_{sys}$  in the standard version is  $t_{sys} = 16/f_c$   
 $t_{sys}$  in the high speed version is  $t_{sys} = 8/f_c$   
 2) The Load of data output delay is  $50pF + 1TTL$

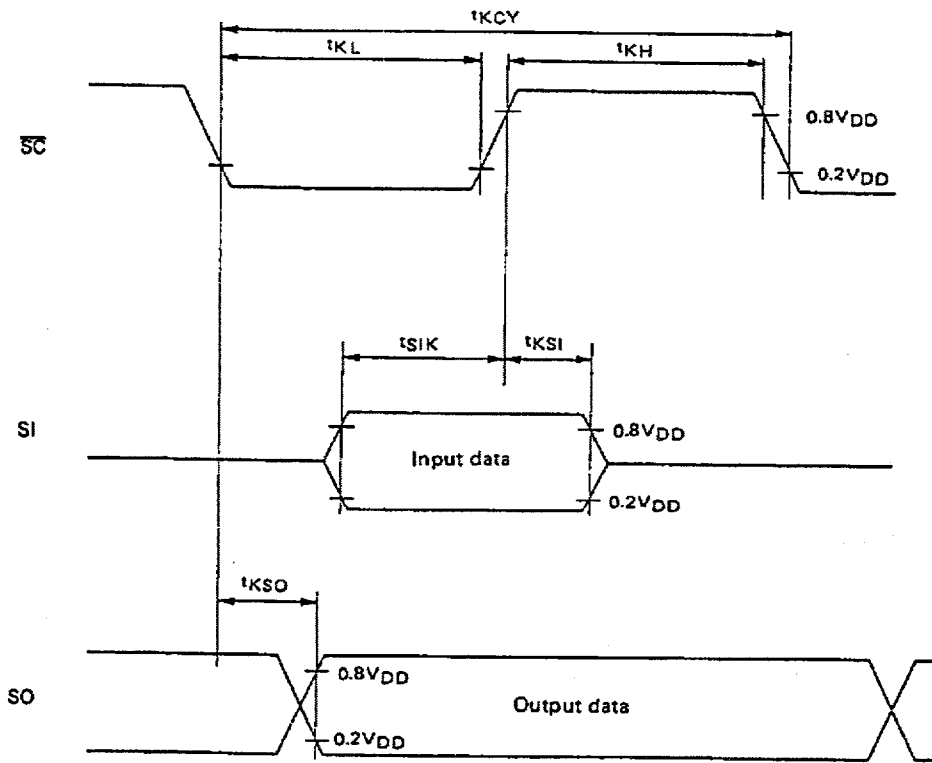

Fig. 4 Serial transfer timing

(3) A/D converter

$T_a = -20^{\circ}\text{C}$  to  $+75^{\circ}\text{C}$ ,  $V_{SS} = 0\text{V}$

Analog input voltage	Pin	Condition	Digital conversion value
0.0 to 0.33V	AD0 to AD7	$V_{DD} = 5\text{V}$	000
0.82 to 1.29V			001
1.78 to 2.21V			010
2.69 to 3.06V			011
3.56 to 4.06V			100
4.62 to 5.0V			101

Note) The digital conversion value are the values when B5H address of the RAM file 1 in the program are read.



(4) Power Supply Voltage Detection Reset Function

Ta = -20°C to +75°C, Vss = 0V

Item	Symbol	Pin	Condition	Min.	Typ.	Max.	Unit
Power supply voltage detection reset function of operation voltage range	V <sub>LPOP</sub>	V <sub>DD</sub>	Voltage range allowing system operation	2.5		5.5	V
Power supply voltage drop detection function	V <sub>POP</sub>	V <sub>DD</sub>	When V <sub>REF</sub> pin voltage is 3.3V Flag set when voltage drops System reset when voltage rises	3.8	4.0	4.2	V

The graph in Fig. 5 shows the relationship between the power supply voltage V<sub>DD</sub> and reference voltage V<sub>REF</sub> of the power supply voltage detection reset function.

Note 1) The graph in Fig. 5 serves as guide to the function operation area obtained using average devices.

Individual adjustment is needed when Zener diodes, etc., are connected to the V<sub>REF</sub> pin.

2) At the rising edge of the power supply, the reset function is activated below 4.5V.

As there is no oscillation stabilization time for resets by the power supply voltage reset function, it is necessary that the voltage of the power supply rises to above 4.5V immediately (approx. 30 μs). Ample consideration is required for the oscillation stabilization time as it varies according to the oscillation element.

(In general, time required for stabilization from the beginning of oscillation is shorter for ceramic oscillators than for crystal oscillators.)

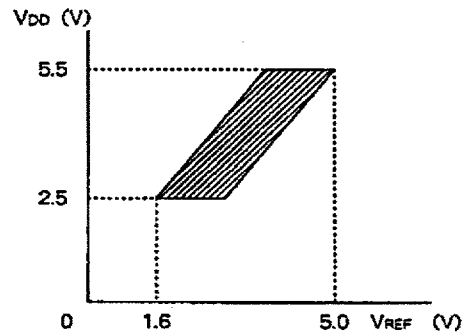

Fig. 5 Power supply voltage detection reset function chart

(5) Others

Ta = -20°C to +75°C, V<sub>DD</sub> = 4.5V to 5.5V, Vss = 0V

Item	Symbol	Pin	Condition	Min.	Max.	Unit
External interruption high and low level widths	t <sub>11H</sub> , t <sub>11L</sub>	INT	During edge detection mode	t <sub>sys</sub> + 0.05		μs
Reset input low level width	t <sub>RSL</sub>	RST		2t <sub>sys</sub>		μs
Wake-up input high level width	t <sub>WPH</sub>	WP	STOP mode	500		ns
			SLEEP mode	t <sub>sys</sub> + 0.05		μs

Note) t<sub>sys</sub> in the standard version is t<sub>sys</sub> = 16/fc  
t<sub>sys</sub> in the high speed version is t<sub>sys</sub> = 8/fc

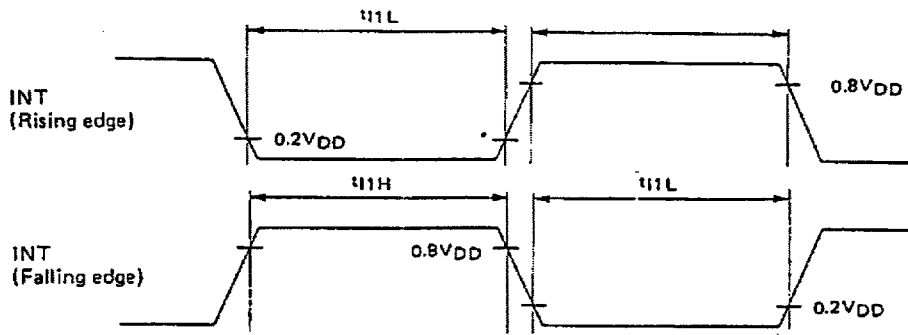

Fig. 6 Interruption input timing

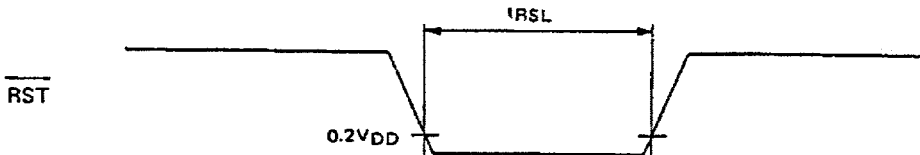

Fig. 7 Reset input timing

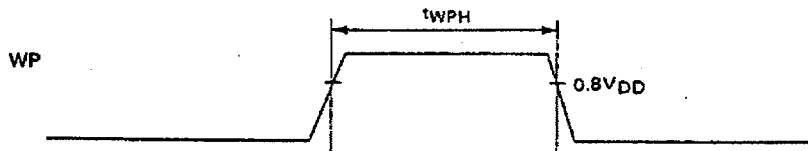

Fig. 8 Wake-up input timing

Power on reset \*

Ta = -20°C to +75°C, Vss = 0V

Item	Symbol	Pin	Condition	Min.	Max.	Unit
Power supply rising time	tR	VDD	Power on reset	0.05	50	ms
Power supply cut-off time	tOFF		Repetitive power on reset	1		ms

\* Specifies only when power on reset function is selected.

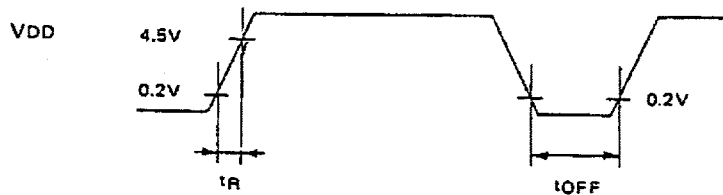

The power supply should rise smoothly.

Fig. 9 Power on reset

**Notes on Application**

See Fig. 10, Additive capacity calculation chart, when using the crystal oscillator and select the appropriate capacity.

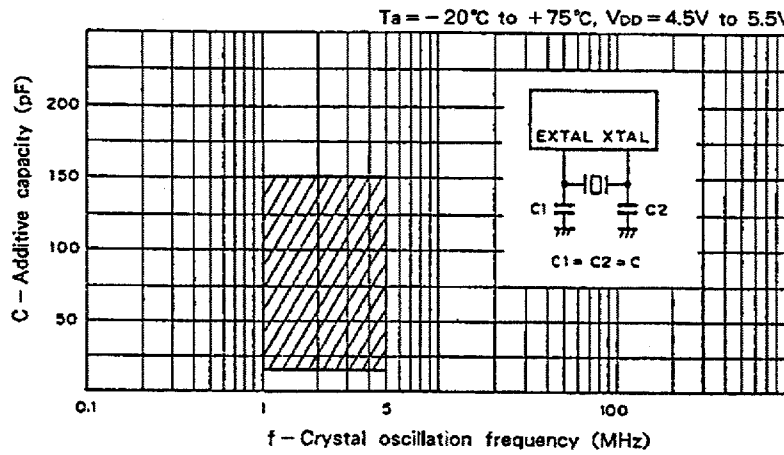
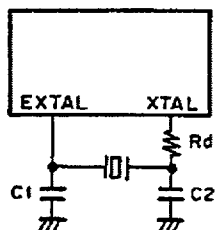

**Fig. 10 Crystal oscillation circuit additive capacity calculation chart**

**Note)** The above chart shows a range in which the average quartz resonator has a relatively fast oscillation rising edge and stable characteristics. The capacity should be selected to correspond to the appropriate constant for each quartz resonator, should the frequency of the quartz resonator be accurately adjusted.

Fig. 11 shows recommended circuits and oscillators.  
 Use the trimmer capacitor to C1, in the case of accurate adjustment of the oscillation frequency.

1. Main clock  
 4.19MHz



Ceramic resonator

Manufacturer	Model	Frequency range(MHz)	C1 (pF)	C2 (pF)	Rd(Ω)
MURATA MFG CO., LTD.	CSA4.19MG040	4.19	100	100	—
	CSA4.19MGW040		built in	built in	—

Crystal oscillator

Manufacturer	Model	Frequency range(MHz)	C1 (pF)	C2 (pF)	Rd(Ω)
CITIZEN WATCH CO., LTD.	CSA309	4.19	10 (20 trimmer)	10	—
NIHON DEMPA KOGYO CO., LTD.	AT-51		15 (20 trimmer)	15	6.8k
KINSEKI LTD.	HC-49/U-S		22 (20 trimmer)	22	3.3k

2. 32kHz Timer/Counter

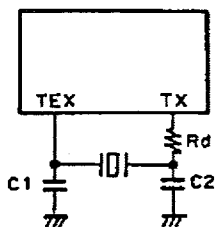

Manufacturer	Model	Frequency range(kHz)	C1 (pF)	C2 (pF)	Rd(Ω)
CITIZEN WATCH CO., LTD.	CFS-308	32.768	18 (20 trimmer)	18	—
NIHON DEMPA KOGYO CO., LTD.	MX-38T		22 (20 trimmer)	22	470k
KINSEKI LTD.	P3		22 (20 trimmer)	22	3.3k

About the details of oscillators, please inquire the makers or the agencies.

Fig. 11 Recommended oscillation circuit

When using the A/D converter as the key input, it is recommended that the circuit structure shown in Fig. 12 be used.

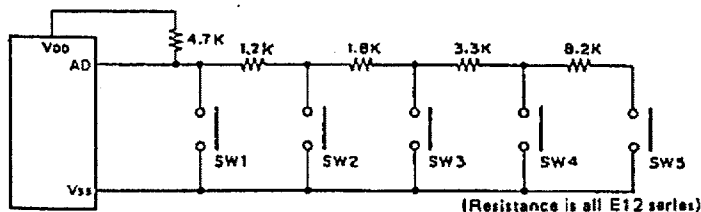

Fig. 12 Recommended example of key circuit by A/D converter