

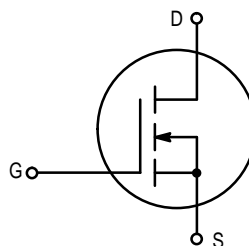
The RF MOSFET Line

RF Power Field Effect Transistor

N-Channel Enhancement-Mode

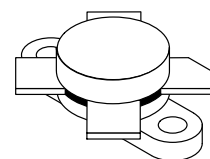
... designed primarily for wideband large-signal output and driver stages up to 200 MHz frequency range.

- Guaranteed Performance at 150 MHz, 28 Vdc
Output Power = 125 Watts
Minimum Gain = 9.0 dB
Efficiency = 50% (Min)
- Excellent Thermal Stability, Ideally Suited For Class A Operation
- Facilitates Manual Gain Control, ALC and Modulation Techniques
- 100% Tested For Load Mismatch At All Phase Angles With 30:1 VSWR
- Low Noise Figure — 3.0 dB Typ at 2.0 A, 150 MHz



MRF174

125 W, to 200 MHz
N-CHANNEL MOS
BROADBAND RF POWER
FET



CASE 211-11, STYLE 2

MAXIMUM RATINGS

Rating	Symbol	Value	Unit
Drain-Source Voltage	V_{DSS}	65	Vdc
Drain-Gate Voltage ($R_{GS} = 1.0 \text{ M}\Omega$)	V_{DGR}	65	Vdc
Gate-Source Voltage	V_{GS}	± 40	Vdc
Drain Current — Continuous	I_D	13	Adc
Total Device Dissipation @ $T_C = 25^\circ\text{C}$ Derate above 25°C	P_D	270 1.54	Watts W/ $^\circ\text{C}$
Storage Temperature Range	T_{stg}	-65 to +150	$^\circ\text{C}$
Operating Junction Temperature	T_J	200	$^\circ\text{C}$

THERMAL CHARACTERISTICS

Characteristic	Symbol	Max	Unit
Thermal Resistance, Junction to Case	$R_{\theta JC}$	0.65	$^\circ\text{C}/\text{W}$

Handling and Packaging — MOS devices are susceptible to damage from electrostatic charge. Reasonable precautions in handling and packaging MOS devices should be observed.

ELECTRICAL CHARACTERISTICS ($T_C = 25^\circ\text{C}$ unless otherwise noted.)

Characteristic	Symbol	Min	Typ	Max	Unit
OFF CHARACTERISTICS					
Drain-Source Breakdown Voltage ($V_{GS} = 0$, $I_D = 50$ mA)	$V_{(BR)DSS}$	65	—	—	Vdc
Zero Gate Voltage Drain Current ($V_{DS} = 28$ V, $V_{GS} = 0$)	I_{DSS}	—	—	10	mAdc
Gate-Source Leakage Current ($V_{GS} = 20$ V, $V_{DS} = 0$)	I_{GSS}	—	—	1.0	μAdc

ON CHARACTERISTICS

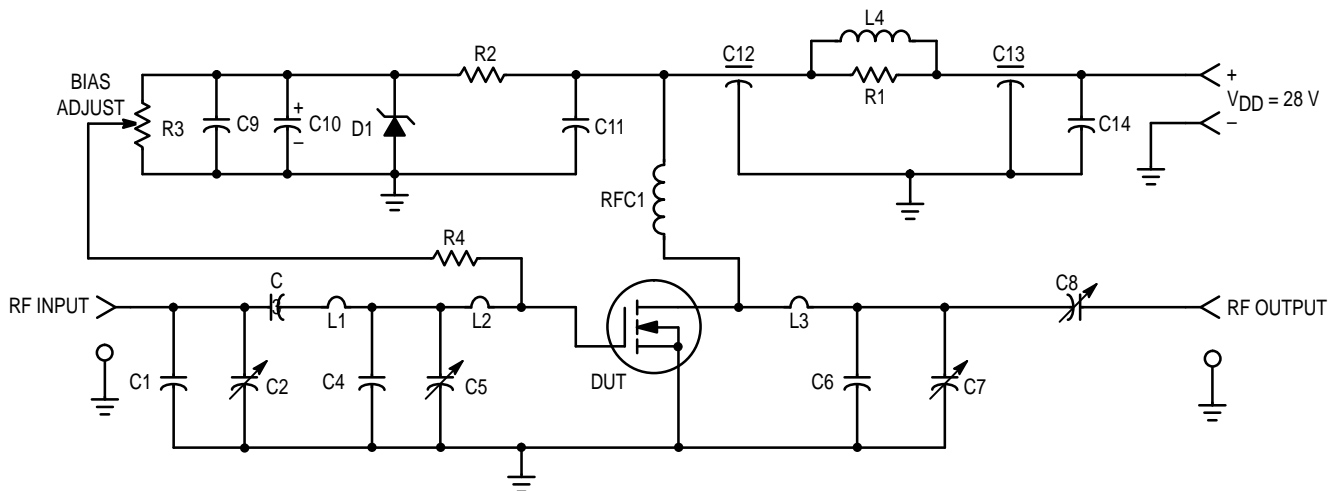
Gate Threshold Voltage ($V_{DS} = 10$ V, $I_D = 100$ mA)	$V_{GS(th)}$	1.0	3.0	6.0	Vdc
Forward Transconductance ($V_{DS} = 10$ V, $I_D = 3.0$ A)	g_{fs}	1.75	2.5	—	mhos

DYNAMIC CHARACTERISTICS

Input Capacitance ($V_{DS} = 28$ V, $V_{GS} = 0$, $f = 1.0$ MHz)	C_{iss}	—	175	—	pF
Output Capacitance ($V_{DS} = 28$ V, $V_{GS} = 0$, $f = 1.0$ MHz)	C_{oss}	—	190	—	pF
Reverse Transfer Capacitance ($V_{DS} = 28$ V, $V_{GS} = 0$, $f = 1.0$ MHz)	C_{rss}	—	40	—	pF

FUNCTIONAL CHARACTERISTICS (Figure 1)

Noise Figure ($V_{DD} = 28$ Vdc, $I_D = 2.0$ A, $f = 150$ MHz)	NF	—	3.0	—	dB
Common Source Power Gain ($V_{DD} = 28$ Vdc, $P_{out} = 125$ W, $f = 150$ MHz, $I_{DQ} = 100$ mA)	G_{ps}	9.0	11.8	—	dB
Drain Efficiency ($V_{DD} = 28$ Vdc, $P_{out} = 125$ W, $f = 150$ MHz, $I_{DQ} = 100$ mA)	η	50	60	—	%
Electrical Ruggedness ($V_{DD} = 28$ Vdc, $P_{out} = 125$ W, $f = 150$ MHz, $I_{DQ} = 100$ mA, VSWR 30:1 at all Phase Angles)	ψ	No Degradation in Output Power			



- C1 — 15 pF Unelco
- C2 — Arco 462, 5.0–80 pF
- C3 — 100 pF Unelco
- C4 — 25 pF Unelco
- C6 — 40 pF Unelco
- C7 — Arco 461, 2.7–30 pF
- C5, C8 — Arco 463, 9.0–180 pF
- C9, C11, C14 — 0.1 μF Erie Redcap
- C10 — 50 μF , 50 V
- C12, C13 — 680 pF Feedthru
- D1 — 1N5925A Motorola Zener

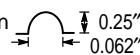
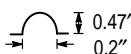
- L1 — #16 AWG, 1–1/4 Turns, 0.213" ID
- L2 — #16 AWG, Hairpin 
- L3 — #14 AWG, Hairpin 
- L4 — 10 Turns #16 AWG Enameled Wire on R1
- RFC1 — 18 Turns #16 AWG Enameled Wire, 0.3" ID
- R1 — 10 Ω , 2.0 W
- R2 — 1.8 k Ω , 1/2 W
- R3 — 10 k Ω , 10 Turn Bourns
- R4 — 10 k Ω , 1/4 W

Figure 1. 150 MHz Test Circuit

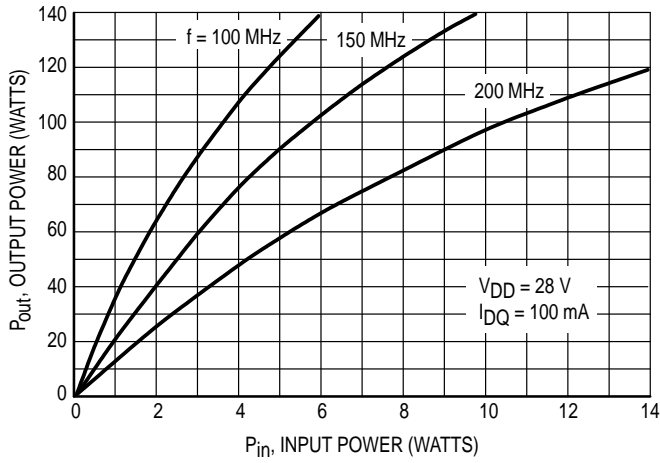


Figure 2. Output Power versus Input Power

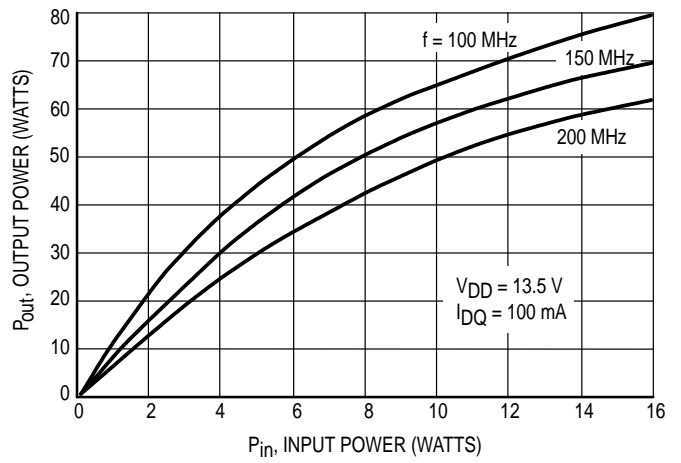


Figure 3. Output Power versus Input Power

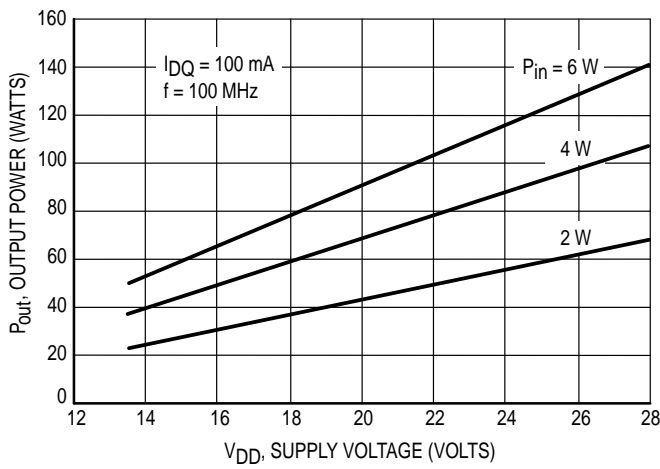


Figure 4. Output Power versus Supply Voltage

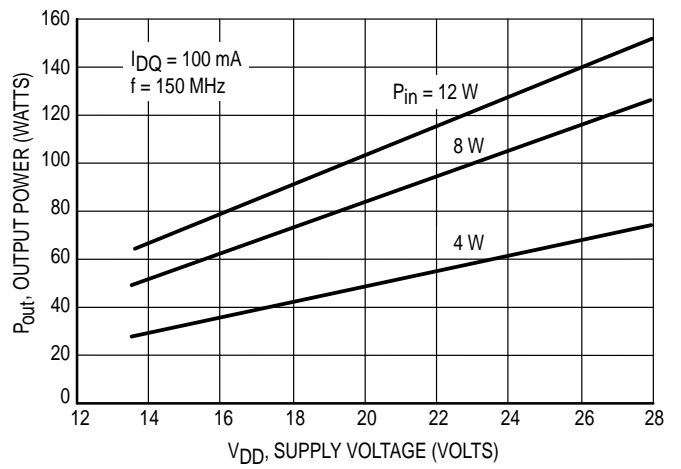


Figure 5. Output Power versus Supply Voltage

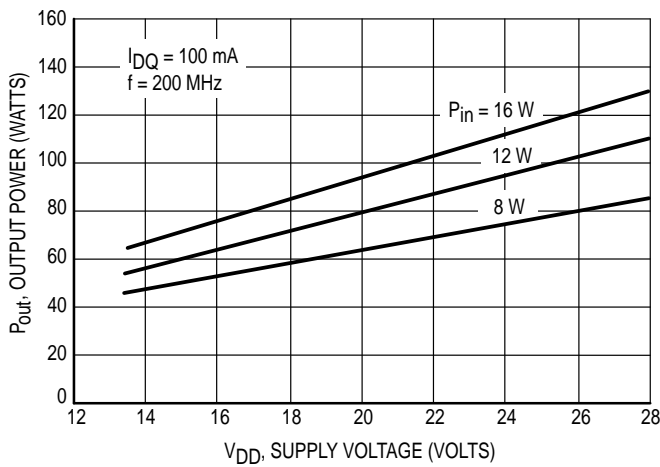


Figure 6. Output Power versus Supply Voltage

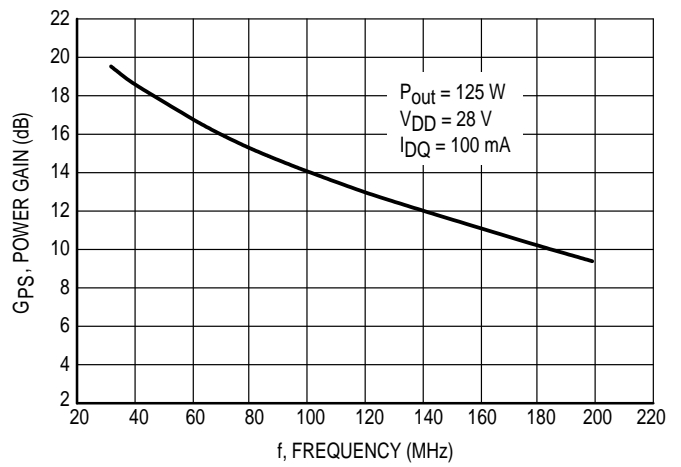


Figure 7. Power Gain versus Frequency

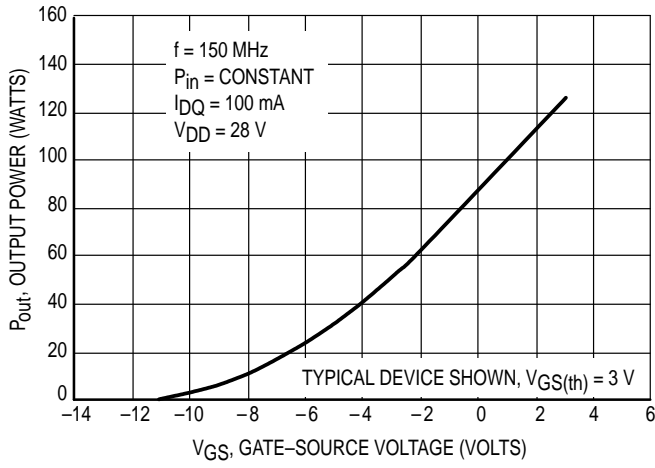


Figure 8. Output Power versus Gate Voltage

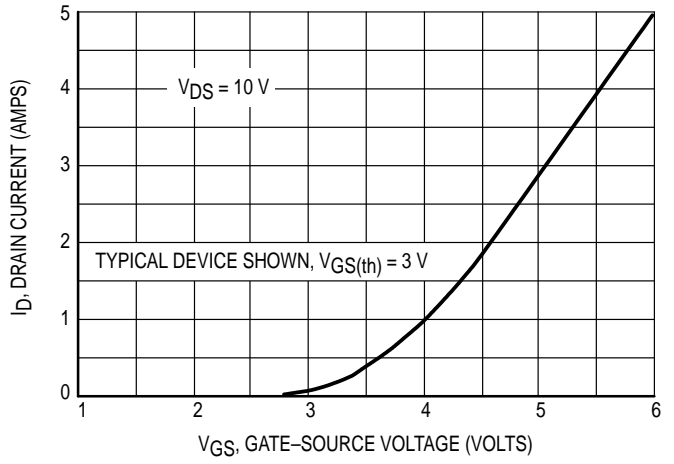


Figure 9. Drain Current versus Gate Voltage (Transfer Characteristics)

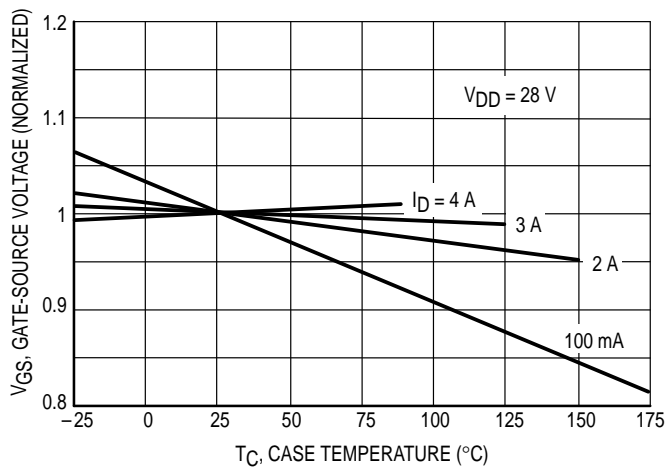


Figure 10. Gate-Source Voltage versus Case Temperature

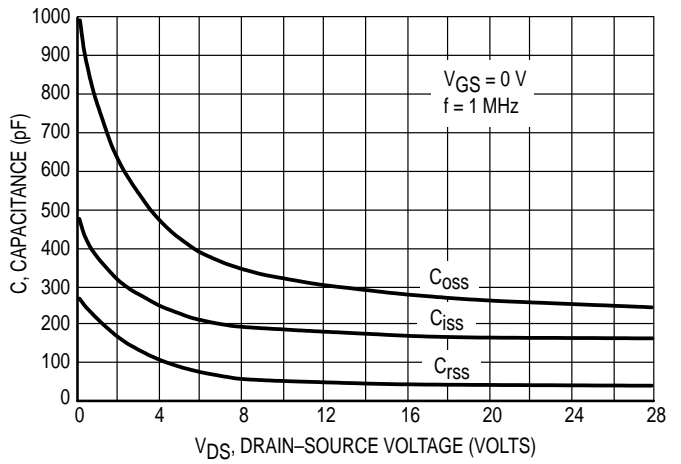


Figure 11. Capacitance versus Drain Voltage

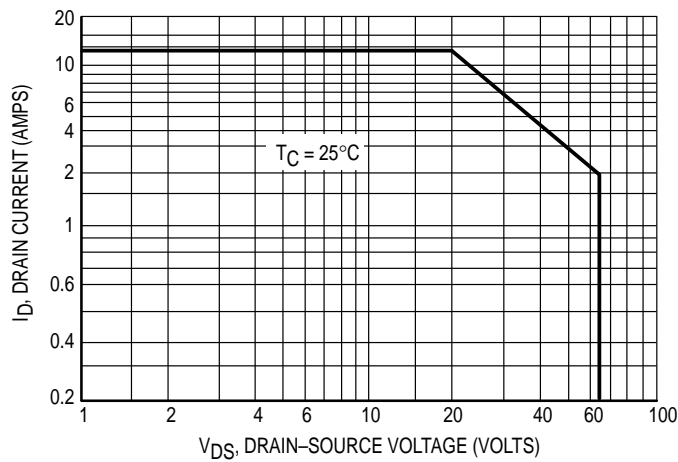


Figure 12. DC Safe Operating Area

f (MHz)	S ₁₁		S ₂₁		S ₁₂		S ₂₂	
	S ₁₁	∠φ	S ₂₁	∠φ	S ₁₂	∠φ	S ₂₂	∠φ
2.0	0.932	-133	74.0	112	0.011	23	0.835	-151
5.0	0.923	-160	31.6	98	0.011	12	0.886	-168
10	0.921	-170	16.0	93	0.011	10	0.896	-174
20	0.921	-175	8.00	88	0.011	12	0.899	-177
30	0.921	-177	5.32	86	0.011	16	0.900	-178
40	0.921	-177	3.98	83	0.012	21	0.901	-178
50	0.922	-178	3.17	81	0.012	26	0.902	-178
60	0.923	-178	2.63	79	0.012	30	0.903	-178
70	0.924	-178	2.24	77	0.013	34	0.904	-178
80	0.925	-178	1.95	75	0.013	39	0.906	-178
90	0.927	-178	1.72	73	0.014	43	0.907	-178
100	0.930	-178	1.50	71	0.016	45	0.910	-178
110	0.930	-178	1.31	70	0.018	46	0.912	-178
120	0.931	-178	1.19	68	0.019	47	0.914	-178
130	0.942	-178	1.10	67	0.019	49	0.919	-178
140	0.936	-178	1.01	66	0.021	50	0.921	-178
150	0.938	-178	0.936	65	0.021	53	0.922	-178
160	0.938	-178	0.879	64	0.022	53	0.923	-178
170	0.940	-178	0.830	63	0.023	54	0.923	-177
180	0.942	-178	0.780	61	0.024	56	0.924	-177
190	0.942	-178	0.737	60	0.026	59	0.928	-177
200	0.952	-178	0.705	59	0.027	58	0.929	-177
210	0.950	-178	0.668	57	0.029	61	0.934	-177
220	0.942	-178	0.626	56	0.030	61	0.933	-177
230	0.943	-178	0.592	56	0.032	62	0.939	-177
240	0.946	-177	0.566	55	0.033	64	0.941	-177
250	0.952	-177	0.545	54	0.035	64	0.943	-177
260	0.958	-177	0.523	53	0.036	65	0.946	-177
270	0.956	-177	0.500	52	0.038	67	0.943	-177
280	0.960	-177	0.481	52	0.039	68	0.946	-177
290	0.956	-178	0.460	51	0.042	68	0.944	-177
300	0.955	-178	0.443	50	0.043	68	0.947	-177

Table 1. Common Source Scattering Parameters
V_{DS} = 28 V, I_D = 3.0 A

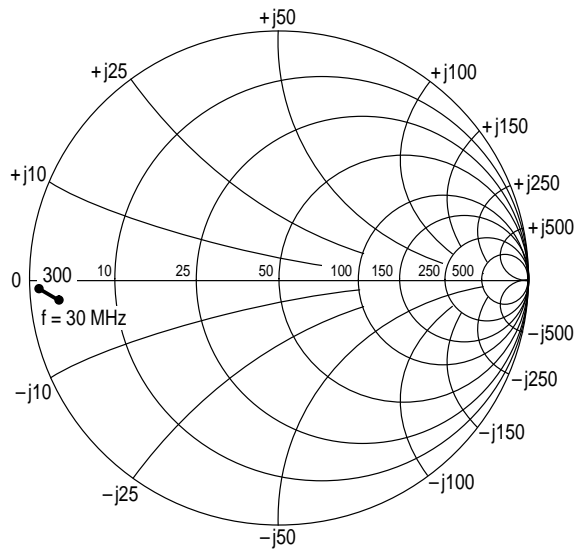


Figure 13. S_{11} , Input Reflection Coefficient versus Frequency
 $V_{DS} = 28 \text{ V}$, $I_D = 3.0 \text{ A}$

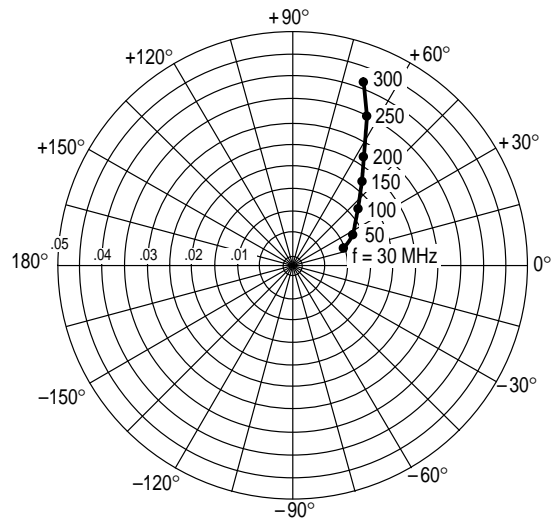


Figure 14. S_{12} , Reverse Transmission Coefficient versus Frequency
 $V_{DS} = 28 \text{ V}$, $I_D = 3.0 \text{ A}$

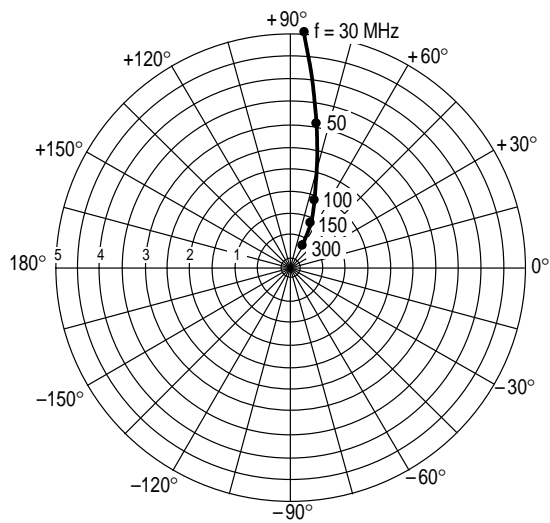


Figure 15. S_{21} , Forward Transmission Coefficient versus Frequency
 $V_{DS} = 28 \text{ V}$, $I_D = 3.0 \text{ A}$

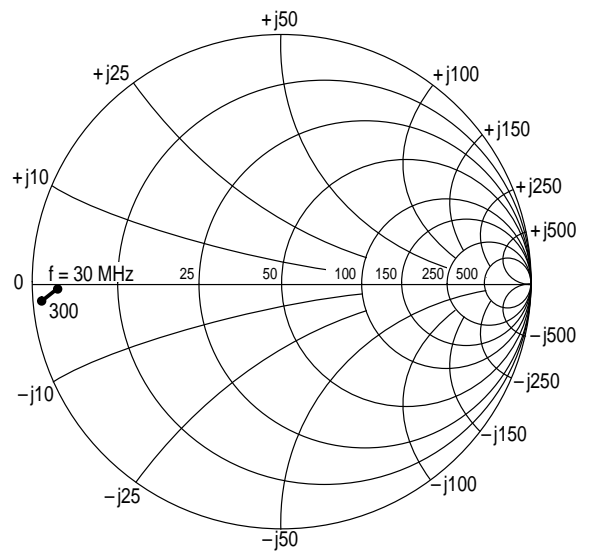


Figure 16. S_{22} , Output Reflection Coefficient versus Frequency
 $V_{DS} = 28 \text{ V}$, $I_D = 3.0 \text{ A}$

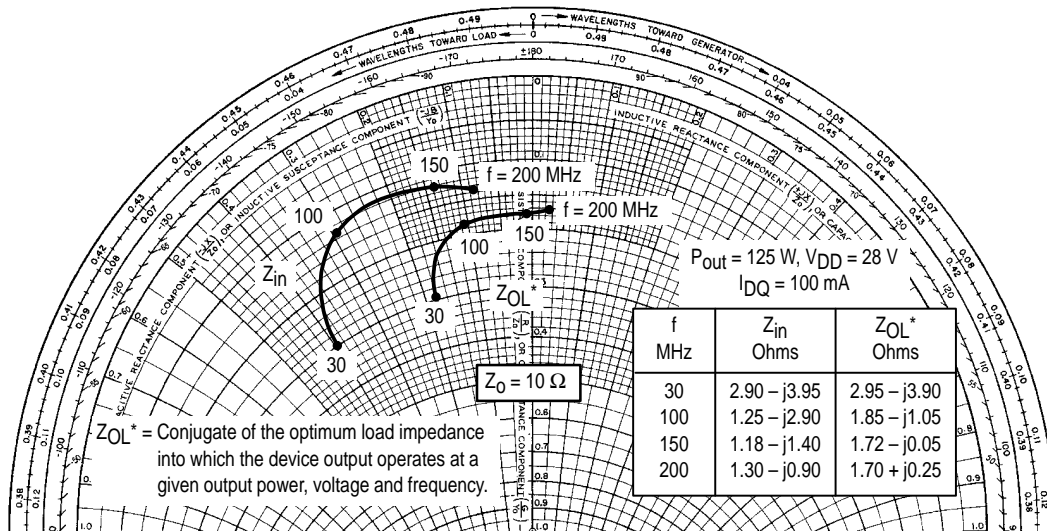


Figure 17. Series Equivalent Input/Output Impedance, Z_{in} , Z_{OL}^*

DESIGN CONSIDERATIONS

The MRF174 is a RF power N-Channel enhancement mode field-effect transistor (FET) designed especially for UHF power amplifier and oscillator applications. Motorola RF MOSFETs feature a vertical structure with a planar design, thus avoiding the processing difficulties associated with V-groove vertical power FETs.

Motorola Application Note AN211A, FETs in Theory and Practice, is suggested reading for those not familiar with the construction and characteristics of FETs.

The major advantages of RF power FETs include high gain, low noise, simple bias systems, relative immunity from thermal runaway, and the ability to withstand severely mismatched loads without suffering damage. Power output can be varied over a wide range with a low power dc control signal, thus facilitating manual gain control, ALC and modulation.

DC BIAS

The MRF174 is an enhancement mode FET and, therefore, does not conduct when drain voltage is applied. Drain current flows when a positive voltage is applied to the gate. See Figure 9 for a typical plot of drain current versus gate voltage. RF power FETs require forward bias for optimum performance. The value of quiescent drain current (I_{DQ}) is not critical for many applications. The MRF174 was charac-

terized at $I_{DQ} = 100$ mA, which is the suggested minimum value of I_{DQ} . For special applications such as linear amplification, I_{DQ} may have to be selected to optimize the critical parameters.

The gate is a dc open circuit and draws no current. Therefore, the gate bias circuit may generally be just a simple resistive divider network. Some special applications may require a more elaborate bias system.

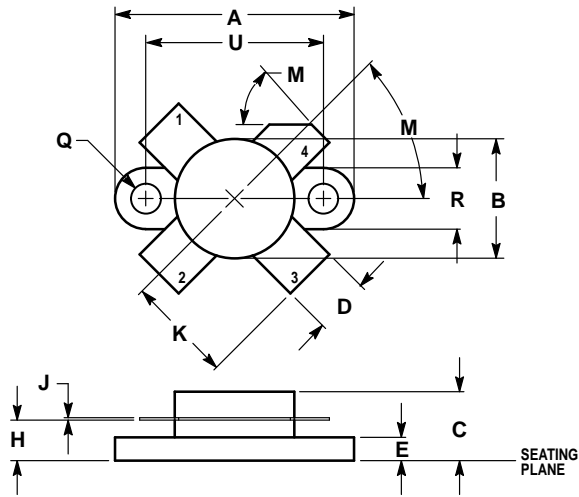
GAIN CONTROL

Power output of the MRF174 may be controlled from its rated value down to zero (negative gain) by varying the dc gate voltage. This feature facilitates the design of manual gain control, AGC/ALC and modulation systems. (See Figure 8.)

AMPLIFIER DESIGN

Impedance matching networks similar to those used with bipolar UHF transistors are suitable for MRF174. See Motorola Application Note AN721, Impedance Matching Networks Applied to RF Power Transistors. The higher input impedance of RF MOSFETs helps ease the task of broadband network design. Both small signal scattering parameters and large signal impedances are provided. While the s-parameters will not produce an exact design solution for high power operation, they do yield a good first approximation. This is an additional advantage of RF MOS power FETs.

PACKAGE DIMENSIONS




- NOTES:
 1. DIMENSIONING AND TOLERANCING PER ANSI Y14.5M, 1982.
 2. CONTROLLING DIMENSION: INCH.

DIM	INCHES		MILLIMETERS	
	MIN	MAX	MIN	MAX
A	0.960	0.990	24.39	25.14
B	0.465	0.510	11.82	12.95
C	0.229	0.275	5.82	6.98
D	0.216	0.235	5.49	5.96
E	0.084	0.110	2.14	2.79
H	0.144	0.178	3.66	4.52
J	0.003	0.007	0.08	0.17
K	0.435	—	11.05	—
M	45°NOM		45°NOM	
Q	0.115	0.130	2.93	3.30
R	0.246	0.255	6.25	6.47
U	0.720	0.730	18.29	18.54

- STYLE 2:
 PIN 1. SOURCE
 2. GATE
 3. SOURCE
 4. DRAIN

**CASE 211-11
 ISSUE N**

Motorola reserves the right to make changes without further notice to any products herein. Motorola makes no warranty, representation or guarantee regarding the suitability of its products for any particular purpose, nor does Motorola assume any liability arising out of the application or use of any product or circuit, and specifically disclaims any and all liability, including without limitation consequential or incidental damages. "Typical" parameters can and do vary in different applications. All operating parameters, including "Typicals" must be validated for each customer application by customer's technical experts. Motorola does not convey any license under its patent rights nor the rights of others. Motorola products are not designed, intended, or authorized for use as components in systems intended for surgical implant into the body, or other applications intended to support or sustain life, or for any other application in which the failure of the Motorola product could create a situation where personal injury or death may occur. Should Buyer purchase or use Motorola products for any such unintended or unauthorized application, Buyer shall indemnify and hold Motorola and its officers, employees, subsidiaries, affiliates, and distributors harmless against all claims, costs, damages, and expenses, and reasonable attorney fees arising out of, directly or indirectly, any claim of personal injury or death associated with such unintended or unauthorized use, even if such claim alleges that Motorola was negligent regarding the design or manufacture of the part. Motorola and  are registered trademarks of Motorola, Inc. Motorola, Inc. is an Equal Opportunity/Affirmative Action Employer.

How to reach us:

USA / EUROPE: Motorola Literature Distribution;
P.O. Box 20912; Phoenix, Arizona 85036. 1-800-441-2447

JAPAN: Nippon Motorola Ltd.; Tatsumi-SPD-JLDC, Toshikatsu Otsuki,
6F Seibu-Butsuryu-Center, 3-14-2 Tatsumi Koto-Ku, Tokyo 135, Japan. 03-3521-8315

MFAX: RMFAX0@email.sps.mot.com - TOUCHTONE (602) 244-6609
INTERNET: <http://Design-NET.com>

HONG KONG: Motorola Semiconductors H.K. Ltd.; 8B Tai Ping Industrial Park,
51 Ting Kok Road, Tai Po, N.T., Hong Kong. 852-26629298



MOTOROLA



MRF174/D

